

TTG-KT88SE Single Ended Output Transformer

Toroidal Single Ended output transformer with UL tap, for tubes KT88, 300B introduces benefits of toroidal cores to tube output. Through the use of innovative, internationally patented winding technology, we have achieved exceptional electrical parameters, such as flat frequency bandwidth in acoustic range, very low THD distortion and high quality factor.

Transformer is also available in stainless steel box potted EXPO version.

Technical Data:

Nominal power:	40W
Nominal anode current:	250mA
Frequency bandwidth (-3dB):	10Hz – 56kHz
Secondary inductance:	4 i 8 Ω
Primary Impedance:	3,0 k Ω
Turns Ratio (Np:Ns):	27,39:1 (4 Ω) , 19,36:1 (8 Ω)
Primary Inductance Lp:	39,5H
Primary Leakage Inductance Lsp:	10,88mH
Total Primary DC Resistance:	85,4 Ω

Core type:	Toroidal
Intended for:	Single Ended, 43% UL

Wiring diagram:

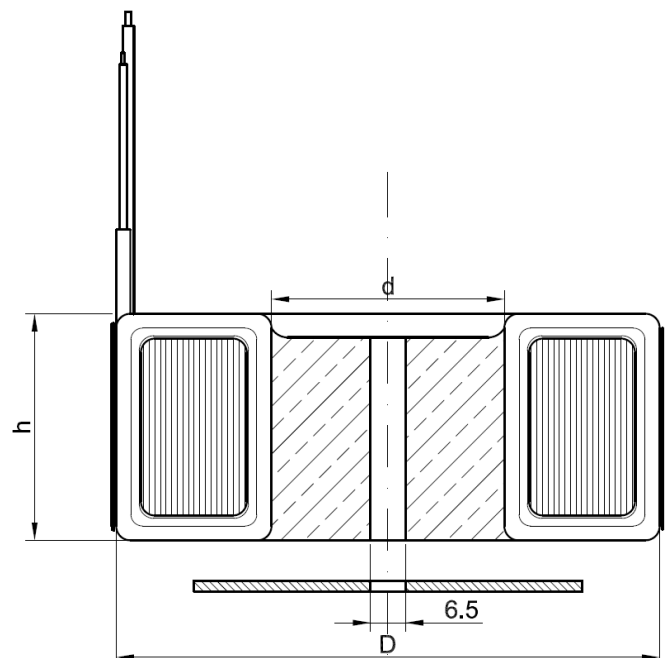
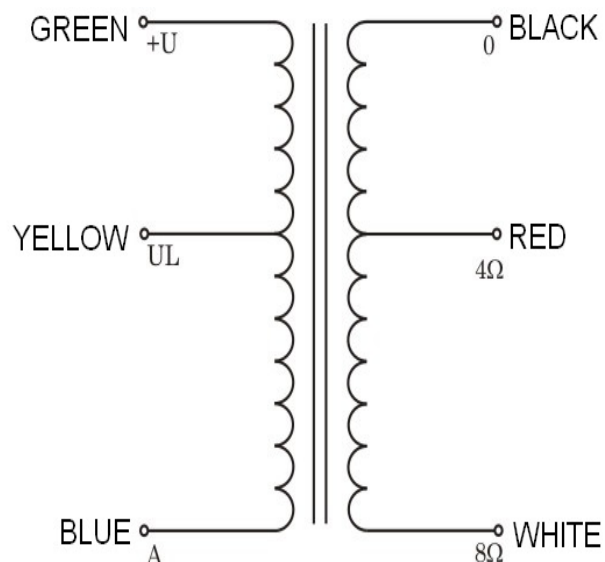

DIMENSIONS:

Outer diameter (D):	115mm
Inner diameter (d):	40mm
Height (h):	65mm
Weight:	2,5 kg
Leads length:	250mm