

A13-54 LIGHTER PLUG WITH SWITCH

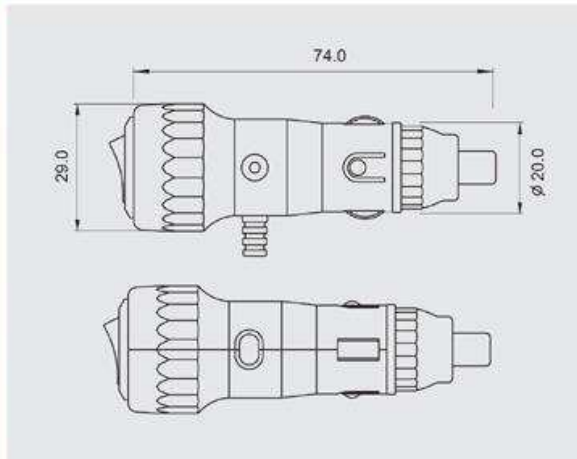

FEATURES

- * RATING : 8A 12V DC
- * MATERIAL:
 - Housing : ABS (UL flame: 94-HB 105°C).
 - Top contact : nickel plated brass.
 - Spring contact : nickel plated spring steel.
- * Lighter plug with on-off LED illuminated switch.
- * Fits wire SPT-1 18 AWG max.
- * With 8A tube fuse max.