

CLICKER 2^{FT90x}

a fast click™ board two-seater

A compact starter kit with your favorite microcontroller and two mikroBUS™ sockets

To our valued customers

I want to express my thanks to you for being interested in our products and for having confidence in MikroElektronika.

The primary aim of our company is to design and produce high quality electronic products and to constantly improve the performance thereof in order to better suit your needs.



Nebojsa Matic
General Manager

Table of Contents

Introduction to clicker 2 for FT90x	4	3.2 Programming with mikroProg™	
Key features	5	programmer	15
1. Power supply	7	mikroProg Suite™ software	16
2. FT900 microcontroller	9	4. Buttons and LEDs	18
Key microcontroller features	9	5. Power management and battery charger	20
3. Programming the microcontroller	10	6. Oscillators	21
3.1 Programming with mikroBootloader	11	7. USB connection	23
step 1 – Connecting clicker 2	11	8. Pads	25
step 2 – Browsing for .HEX file	12	9. Pinout	26
step 3 – Selecting .HEX file	12	9.1 mikroBUS™ pinout	27
step 4 – Uploading .HEX file	13	10. click™ boards are plug and play!	28
step 5 – Finish upload	14	11. Dimensions	30

Introduction to clicker 2 for FT90x

Clicker 2 for FT90x is a compact dev. kit with two mikroBUS™ sockets for click™ board connectivity. You can use it to quickly build your own gadgets with unique functionalities and features.

It carries the FT900, a 32-bit FT32 core microcontroller, two indication LEDs, two general purpose buttons, a reset button, an on/off switch, a li-polymer battery connector, a USB Mini-B connector and two mikroBUS™ socket. A mikroProg connector and a 2x26 pinout for interfacing with external electronics are also provided. The mikroBUS™ connector consists of two

1x8 female headers with SPI, I²C, UART, RST, PWM, Analog and Interrupt lines as well as 3.3V, 5V and GND power lines. Clicker 2 for FT90x board can be powered over a USB cable.



power supply
via USB cable (5V DC)



board dimensions
60.4 x 81 mm [2.4 x 3.2 inch]



weight
26 g [0.057 lbs]

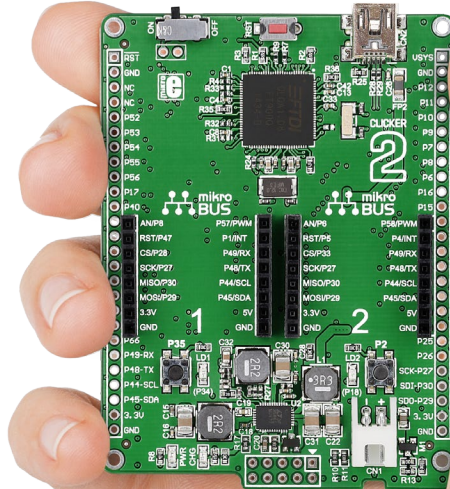

Key features

- 1 ON/OFF switch
- 2 Pads for connecting external ON/OFF switch
- 3 FT900Q
- 4 32.768 kHz crystal oscillator
- 5 12 mHz crystal oscillator
- 6 2x26 connection pads
- 7 mikroBUS™ sockets 1 and 2
- 8 Pushbuttons
- 9 Additional LEDs
- 10 LTC3586 USB power manager IC
- 11 Power and Charge indication LEDs
- 12 RESET button
- 13 USB mini-B connector
- 14 Li-Polymer battery connector
- 15 Programmer connector

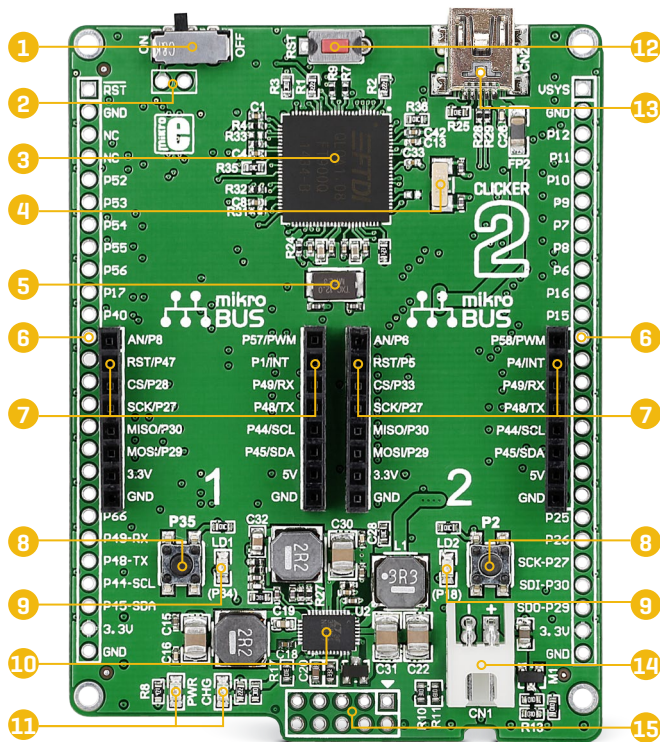

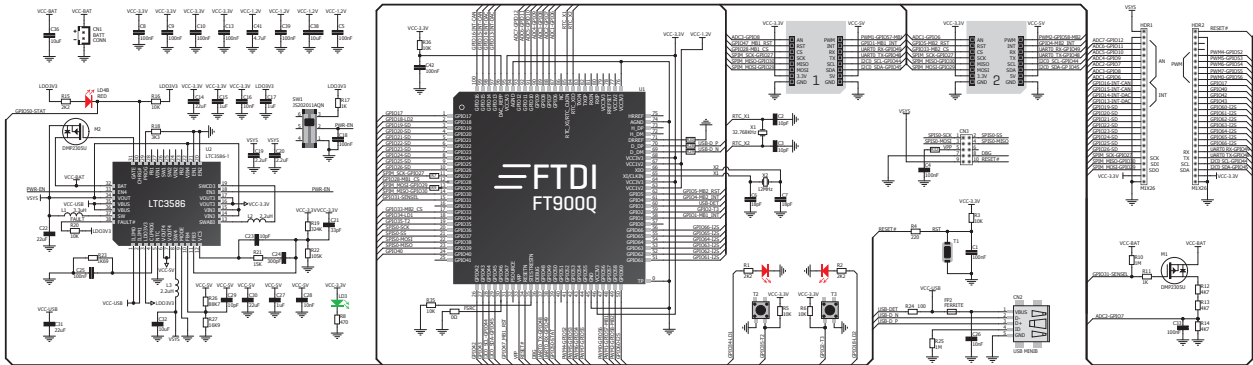

clicker 2 for FT90x schematic

1. Power supply

USB power supply

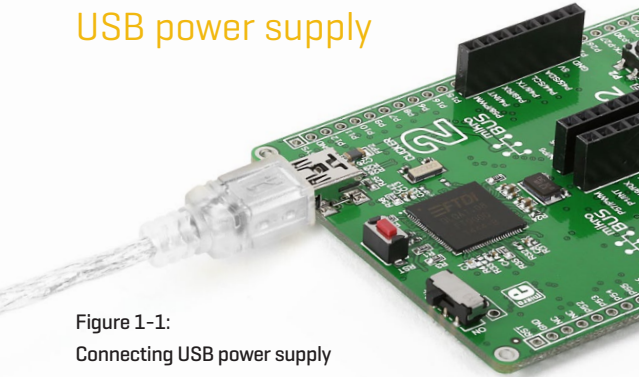

Figure 1-1:
Connecting USB power supply

You can supply power to the board with a **Mini-B USB** cable provided in the package. On-board voltage regulators provide the appropriate voltage levels to each component on the board. **Power LED (GREEN)** will indicate the presence of power supply.

NOTE | *click™ boards that use a 3.3V power supply can draw up to 750 mA of current, which is more current than a USB can supply (500 mA); In those cases you would need to use the battery as the power supply, or the vsys pin on the side of the board.*

Battery power supply

You can also power the board using a **Li-Polymer** battery, via on-board battery connector. On-board battery charger circuit enables you to charge the battery over USB connection. **LED diode (RED)** will indicate when battery is charging. Charging current is ~300mA and charging voltage is 4.2V DC.

Figure 1-2: Connecting
Li-Polymer battery

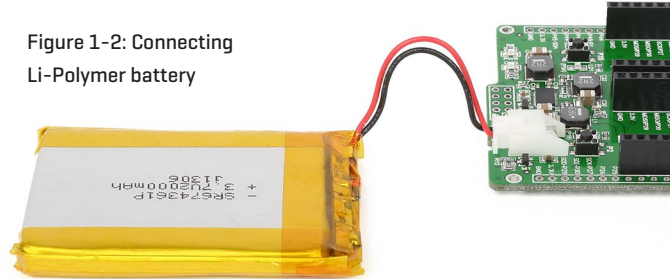

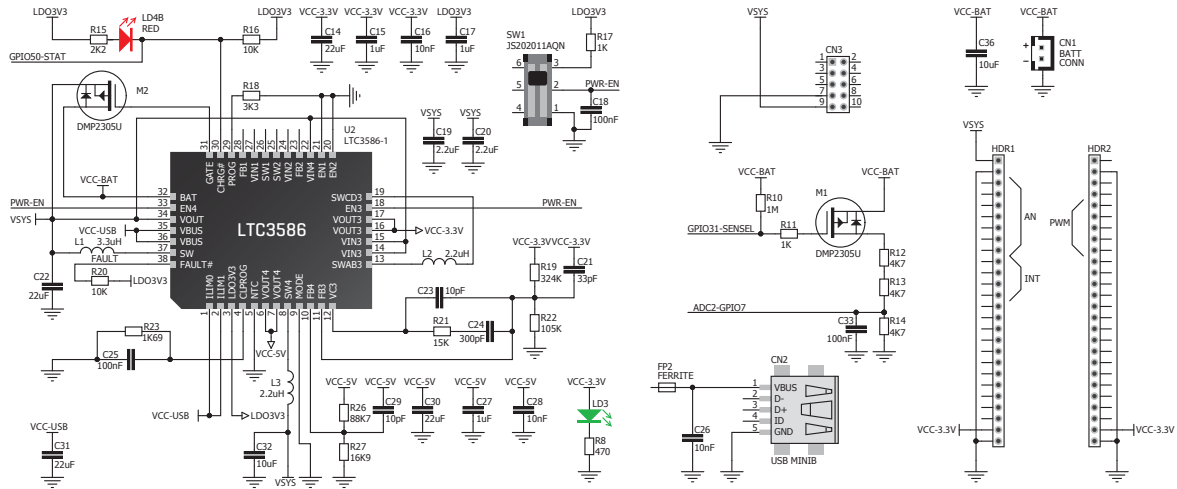

Figure 1-3: Power supply schematic

2. FT900 microcontroller

The FT90x clicker development tool comes with the **FT900Q** microcontroller. This 32-bit FT32 Core high performance microcontroller executes instructions from Shadow RAM, achieving true zero wait states at up to 100MHz, resulting in 310 DMIPS of performance.

Key microcontroller features

- 310 DMIPS/ 100MHz, 32-bit FT32 Core
- 256kB Flash memory
- 64kb Data memory
- 256kB Shadow program memory
- 67 I/O pins
- SPI, I²C, I²S, A/D, UART, Ethernet, DAC, CAN, SD
- 16-bit, 32-bit Digital Timers
- Camera parallel interface
- RTCC, one wire debugger, etc.



3. Programming the microcontroller

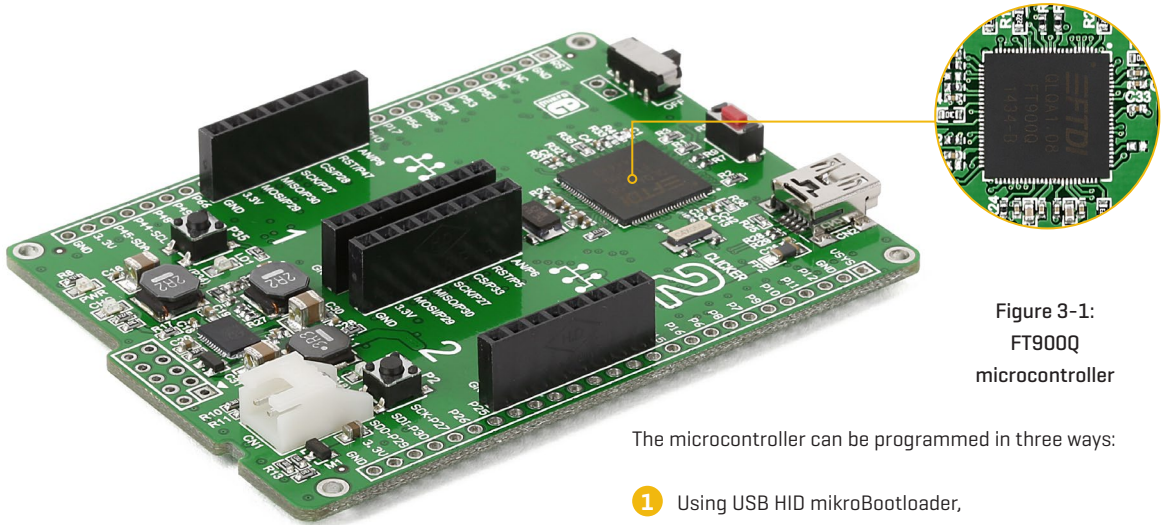

Figure 3-1:
FT900Q
microcontroller

The microcontroller can be programmed in three ways:

- 1 Using USB HID mikroBootloader,
- 2 Using external mikroProg™ for FT90x programmer

3.1 Programming with mikroBootloader

You can program the microcontroller with a bootloader which is preprogrammed by default. To transfer .hex file from a PC to MCU you need bootloader software (**mikroBootloader USB HID**) which can be downloaded from:

➔ www.mikroe.com/downloads/get/2230/clicker_2_ft90x_bootloader.zip

After the mikroBootloader software is downloaded, unzip it to desired location and start it.

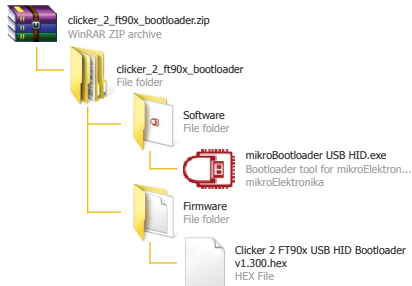

step 1 – Connecting clicker 2 for FT90x



Figure 3-2: USB HID mikroBootloader window

- 1 To start, connect the USB cable, or if already connected press the **Reset** button on your clicker 2 for FT90x. Click the **Connect** button within 5s to enter the bootloader mode, otherwise existing microcontroller program will execute.

step 2 – Browsing for .HEX file



Figure 3-3: Browse for HEX

1 Click the **Browse for HEX** button and from a pop-up window (Figure 3.4) choose the .HEX file which will be uploaded to MCU memory.

step 3 – Selecting .HEX file

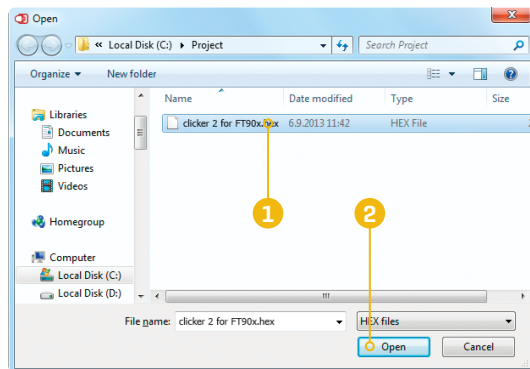

Figure 3-4: Selecting HEX

- 1 Select .HEX file using open dialog window.
- 2 Click the **Open** button.

step 4 – Uploading .HEX file



Figure 3-5: Begin uploading

- 1 To start .HEX file bootloading click the **Begin uploading** button.

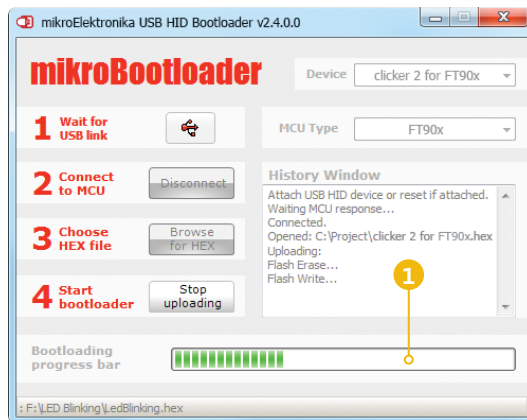

Figure 3-6: Progress bar

- 1 Progress bar enables you to monitor .HEX file uploading.

step 5 – Finish upload

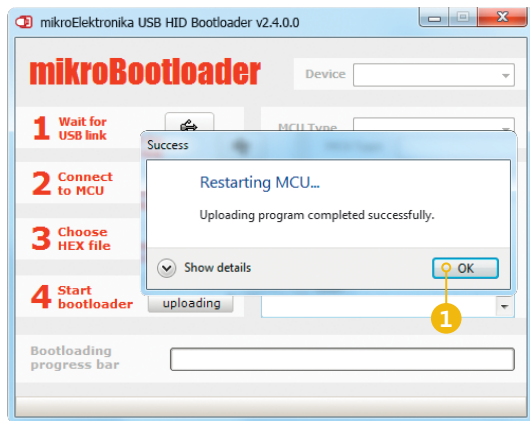

Figure 3-7: Restarting MCU

- 1 Click **OK** button after the uploading process is finished.
- 2 Press **Reset** button on clicker 2 for FT90x board and wait for 5 seconds. Your program will run automatically.



Figure 3-8: mikroBootloader ready for next job

3.2 Programming with mikroProg™ programmer

The microcontroller can be programmed with external **mikroProg™ for FT90x programmer** and **mikroProg Suite™ for FT90x® software**.

The external programmer is connected to the development system via 2x5 connector

Figure 3-9. mikroProg™ is a fast USB 2.0 programmer with hardware debugger support. It supports all FT90x devices in a single programmer.

Outstanding performance, easy operation and elegant design are its key features.

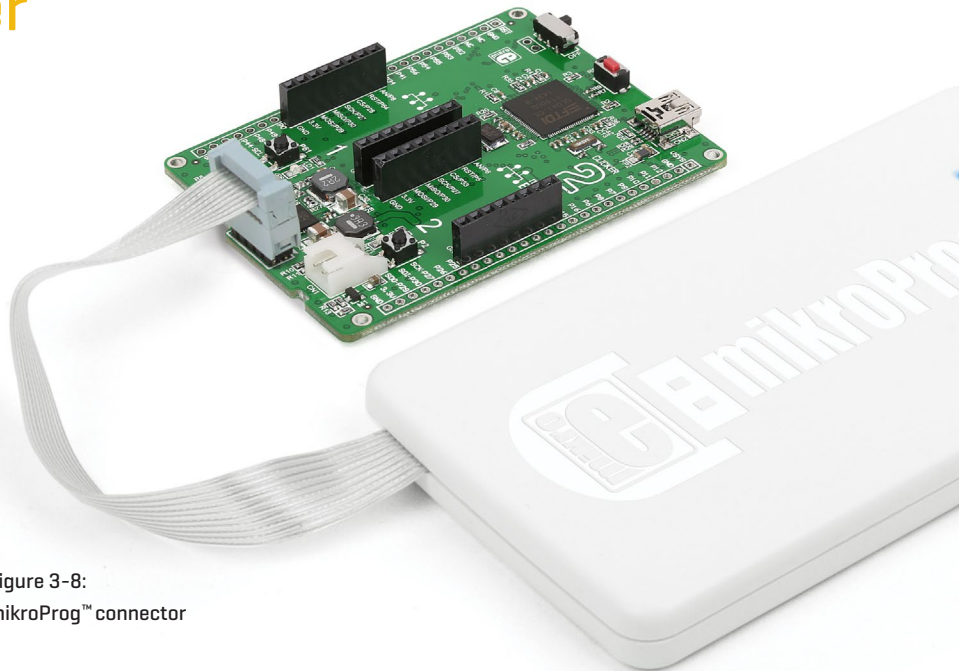

Figure 3-8:
mikroProg™ connector

mikroProg Suite™ for FT90x software

A standalone programming software utility called **mikroProg Suite™ for FT90x** is available as an alternative to programming the MCU directly from the FT90x compiler. This software is used for programming of all supported FT90x microcontrollers. The software has an intuitive interface and **SingleClick™** programming technology. To begin, first locate the installation archive on our web site:

➔ www.mikroe.com/downloads/get/2215/mikroprog_suite_ft90x_v100.zip

After downloading, extract the package and double click the executable setup file, to start the installation.

Quick guide

- 1 Click the **Detect MCU** button in order to recognize the device ID.
- 2 Click the **Read** button to read the entire microcontroller memory. You can click the **Save** button to save it to the target HEX file.
- 3 If you want to write the HEX file into the microcontroller, first make sure to load the target HEX file using the **Load** button. Then click the **Write** button to begin programming.
- 4 Click the **Erase** button to clear the microcontroller memory.

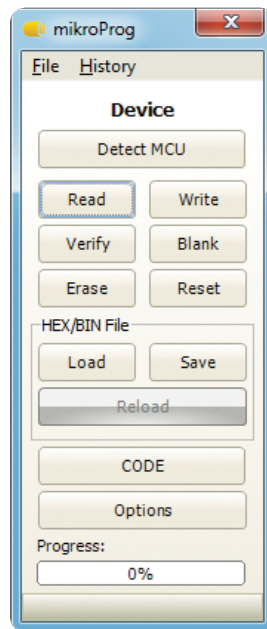
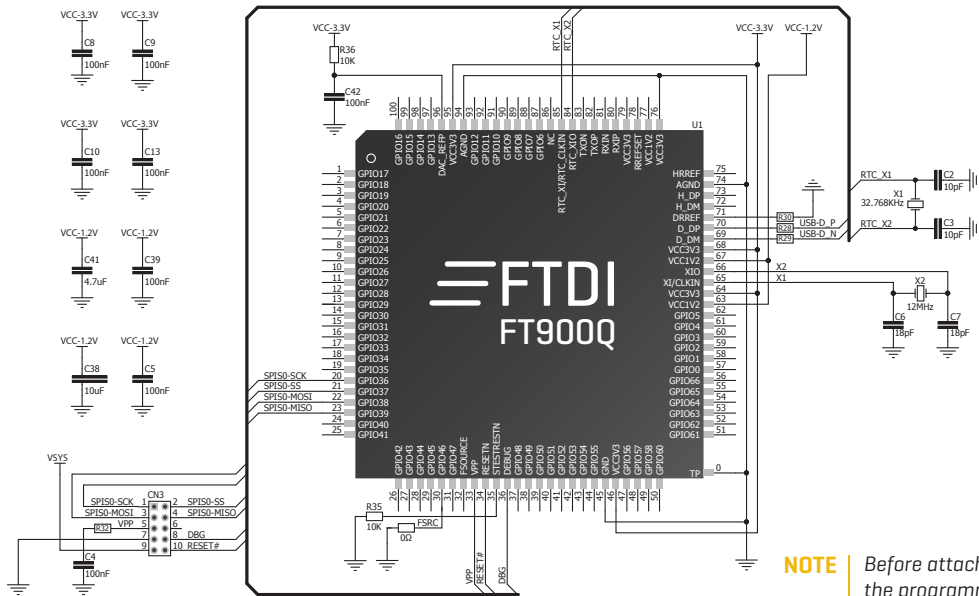

Figure 3-10:
mikroProg Suite™ for
FT90x window



NOTE Before attaching the programming connector, you have to solder the provided 2x5 male header to the connection pads.

Figure 3-13: mikroProg™ connection schematic

4. Buttons and LEDs

The board also contains a **1 reset button** and a pair of **2 buttons** and **3 LEDs**, as well as an ON/OFF switch.

The **Reset button** is used to manually reset the microcontroller — it generates a low voltage level on the microcontroller's reset pin. **LEDs** can be used for visual indication of the logic state on two pins (**P34** and **P18**). An active LED indicates that a logic high [1] is present on the pin. Pressing any of the two **buttons** can change the logic state of the microcontroller pins (**P35** and **P2**) from logic high [1] to logic low [0]. In addition to the onboard ON/OFF switch, two pins allow you to connect your own external switch (located beneath the switch).

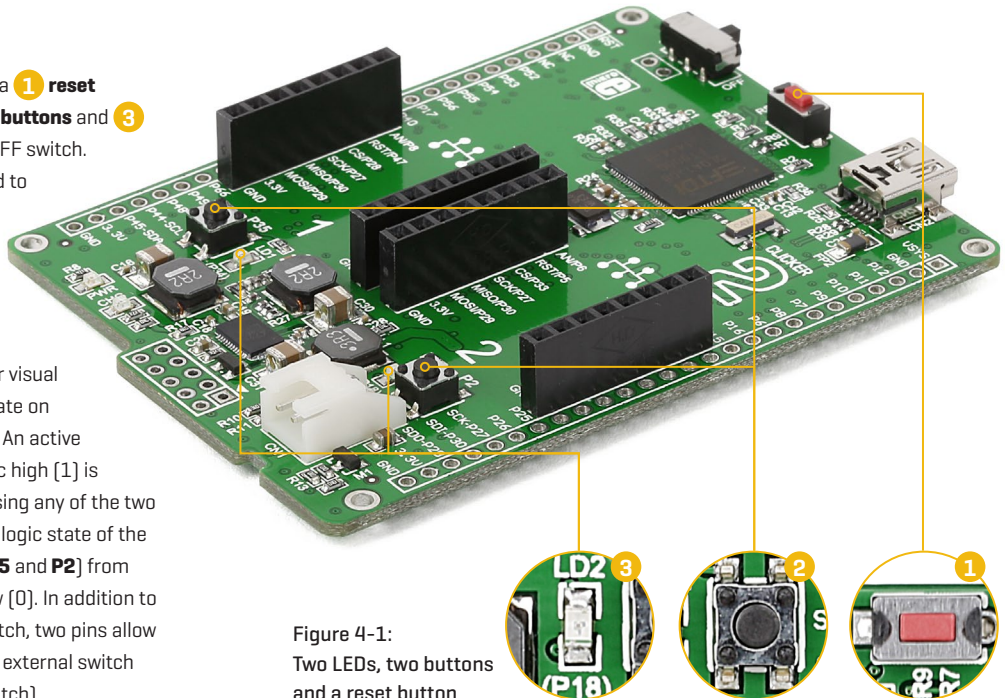

Figure 4-1:
Two LEDs, two buttons
and a reset button

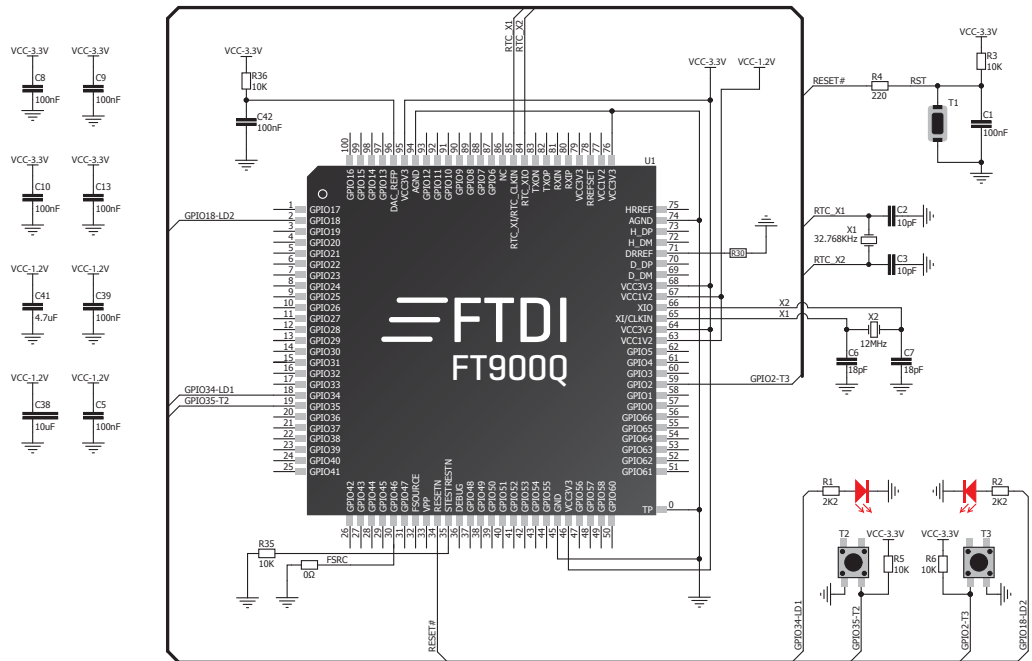
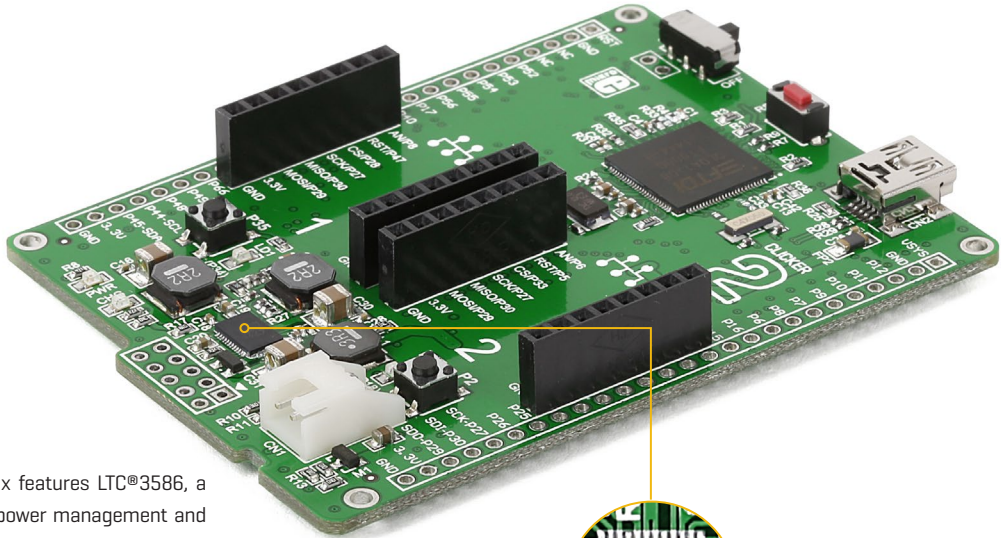

Figure 4-2: Other modules connection schematic

5. Power management and battery charger



Clicker 2 for FT90x features LTC®3586, a highly integrated power management and battery charger IC that includes a current limited switching PowerPath manager. LTC®3586 also enables battery charging over a USB connection.

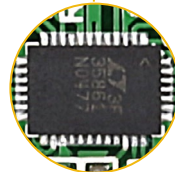
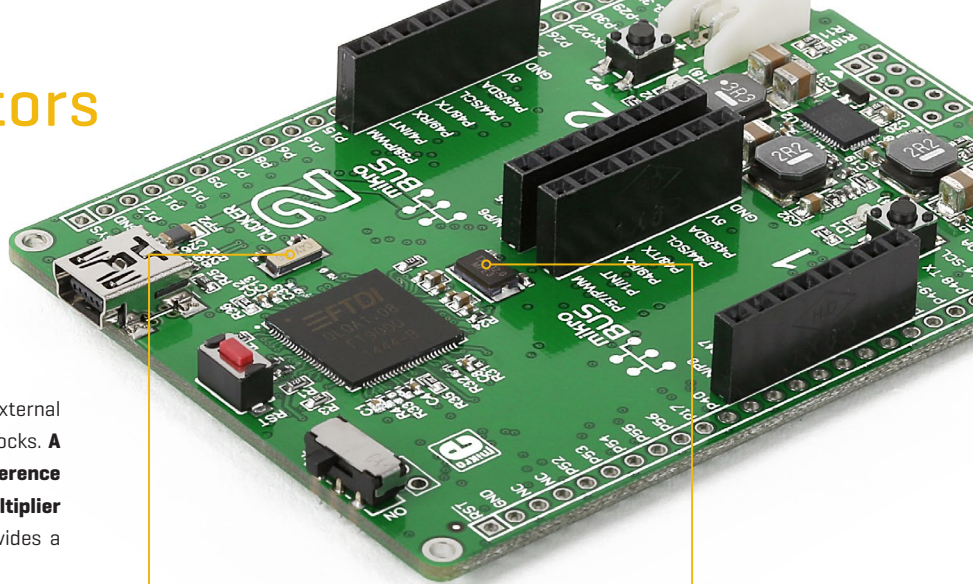

Figure 5-2: power management and battery charger IC

6. Oscillators



Two onboard oscillators act as external sources for FT90x's two system clocks. A **12 MHz oscillator provides a reference frequency output to the clock multiplier PLL**. A **32.768kHz** oscillator provides a clock for the internal RTCC.

Figure 6-1:
32.768 kHz crystal
oscillator module
[X2]

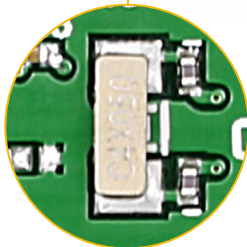

Figure 6-2:
12MHz crystal
oscillator module
[X1]



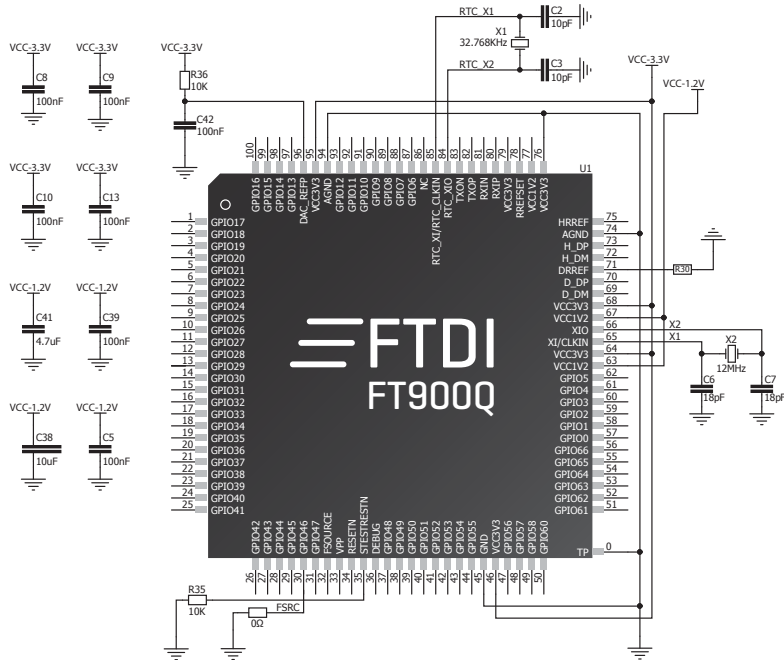

Figure 6-3: Crystal oscillator schematic

7. USB connection

FT90x microcontrollers has an integrated USB module, which enables you to implement USB communication functionality to your clicker 2 board. Connection with target USB host is done over a Mini-B USB connector which is positioned next to the battery connector.

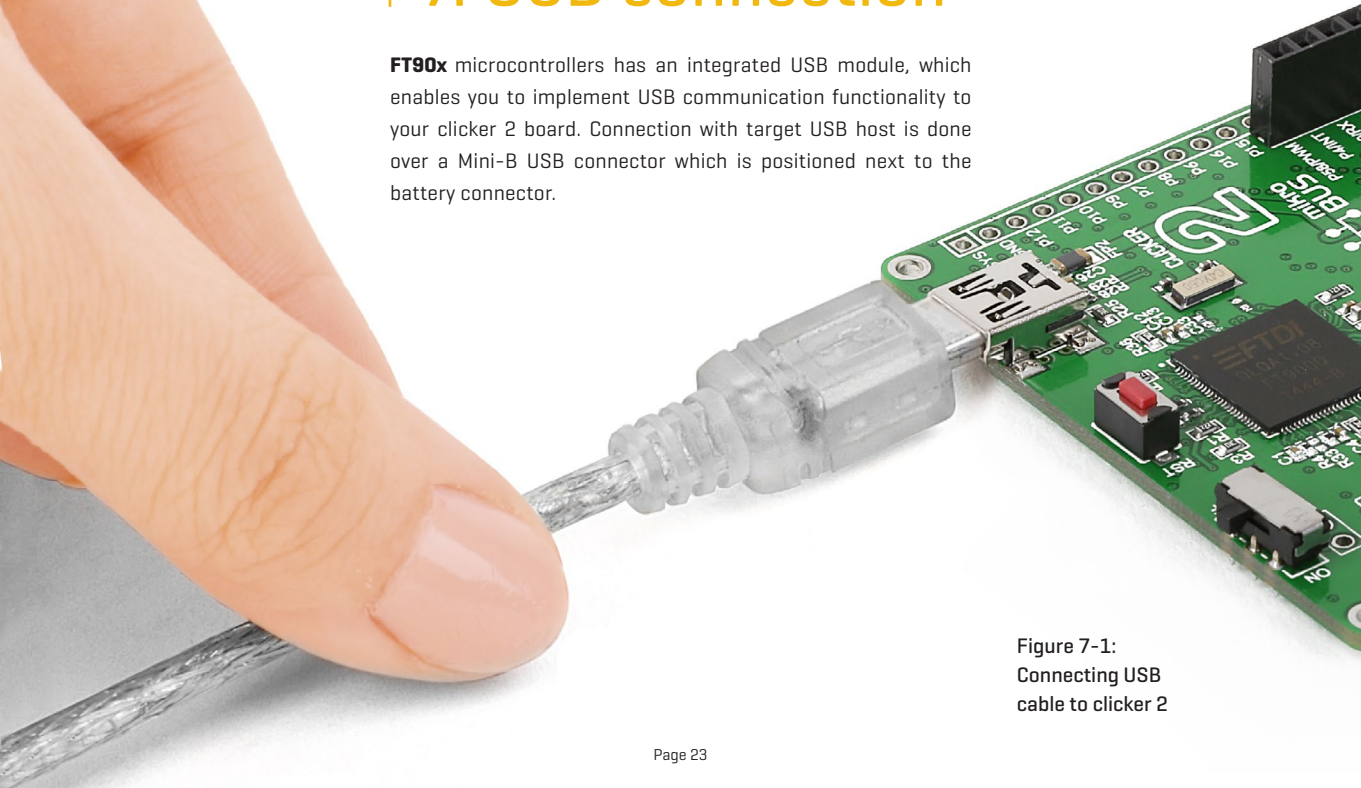

Figure 7-1:
Connecting USB
cable to clicker 2

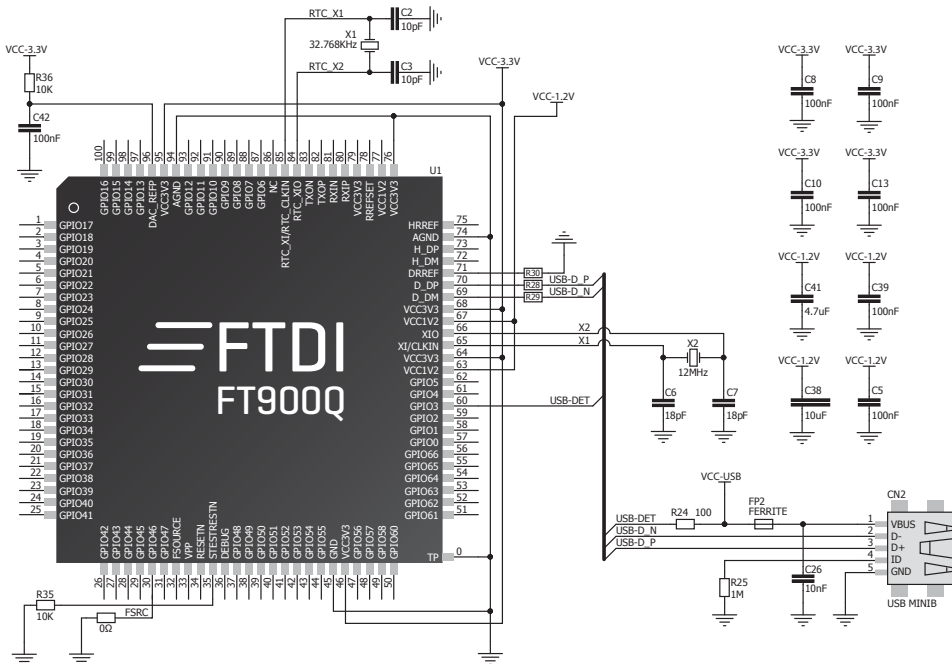
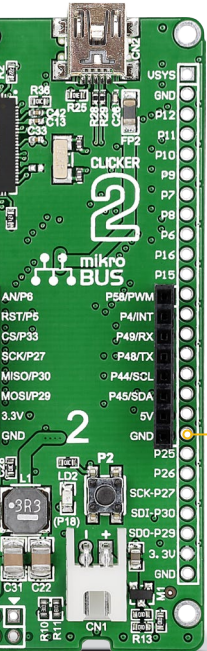

Figure 7-2: USB module connection schematic

8. Pads



Pads HDR2

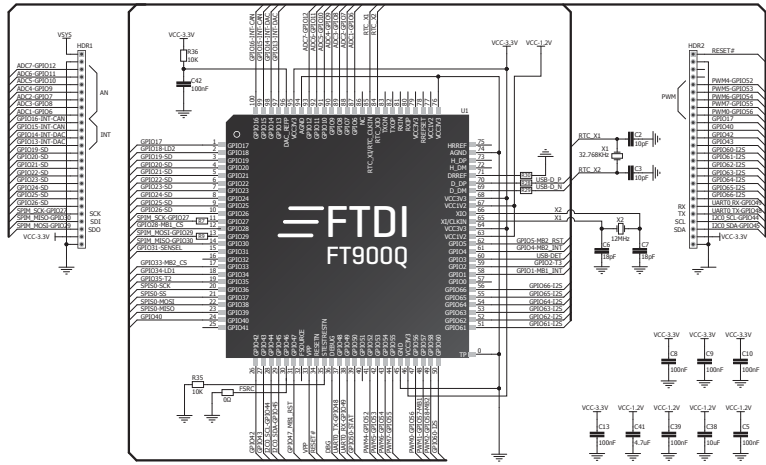

Figure 8-1: Connecting pads schematic



Pads HDR1

Most microcontroller pins are available for further connectivity via two 1x26 rows of connection pads on both sides of the clicker 2 for FT90x board. They are designed to match additional shields, such as Battery Boost shield, Gaming, PROTO shield and others.

9. Pinout

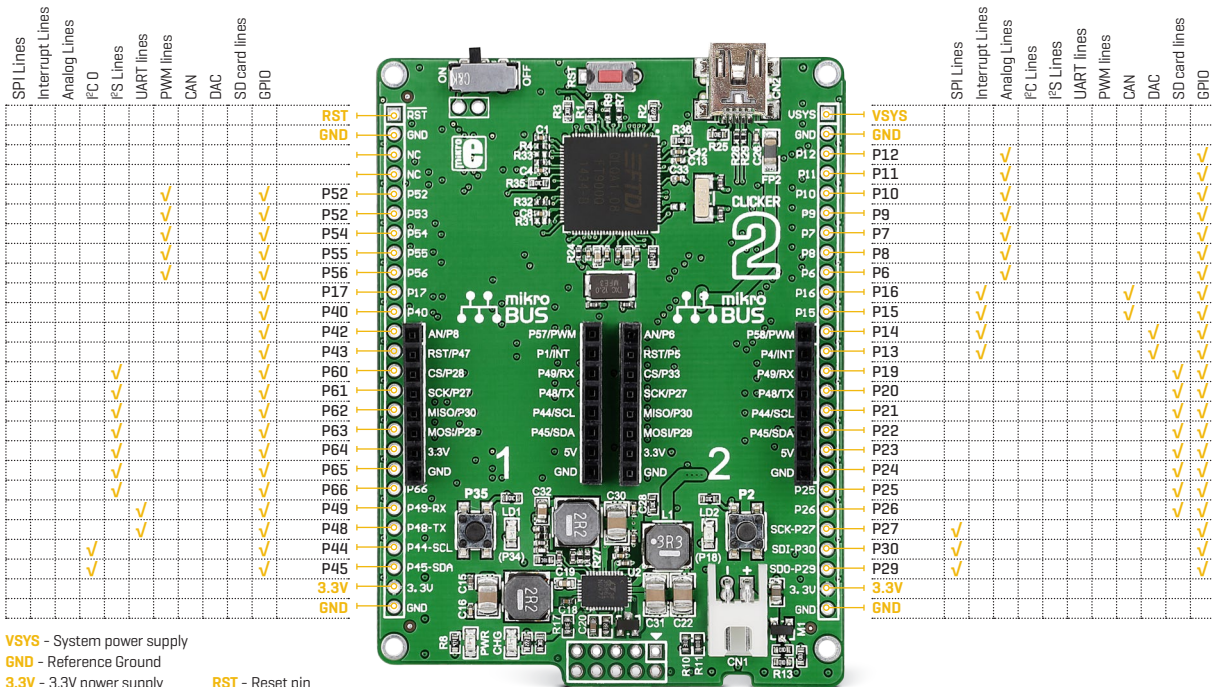

9.1 mikroBUS™ pinouts

Having two mikroBUS™ sockets and an additional connection pad, clicker 2 for FT90x utilizes all of the FT90x's I/Os. Single UART, I²C, and SPI lines are shared between two mikroBUS™ sockets but are also available from the two 1x26 connection pads on the edges of the board.

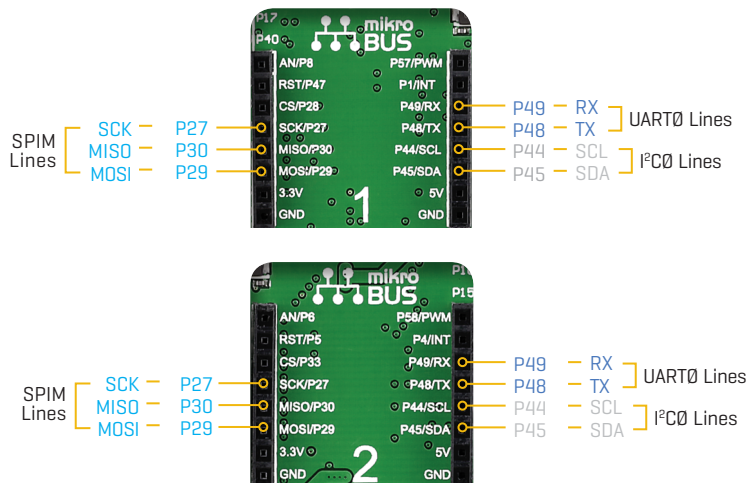

Figure 9-1:
mikroBUS™ individual
and shared lines

10. click™ boards are plug and play!

Up to now, MikroElektronika has released more than a 100 mikroBUS™ compatible click™ boards. On the average, one click™ board is released per week. It is our intention to provide you with as many add-on boards as possible, so you will be able to expand your development board with additional functionality. Each board comes with a set of working example code. Please visit the click™ boards webpage for the complete list of currently available boards:

www.mikroe.com/click

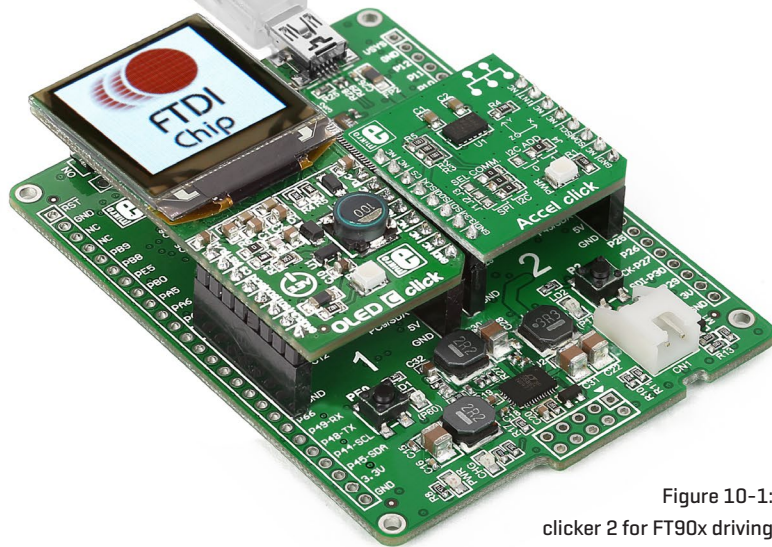
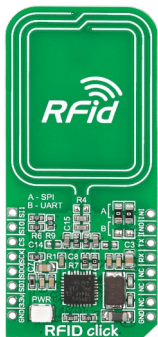
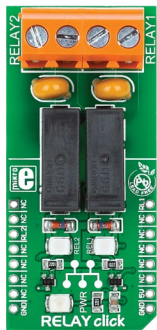

Figure 10-1:
clicker 2 for FT90x driving
click™ boards



RFid click™



Relay click™

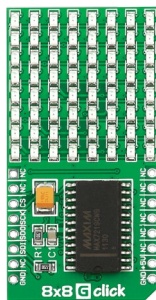

8x8 click™

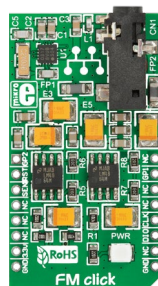

FM click™



Bluetooth2 click™



Thunder click™

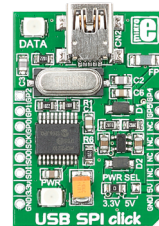

USB SPI click™

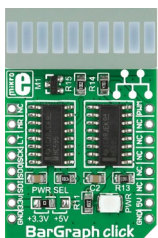

BarGraph click™

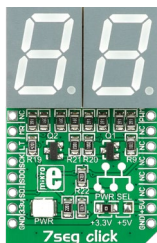

7seg click™



THERMO click™

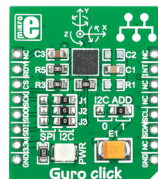

Gyro click™

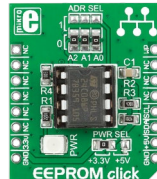

EEPROM click™

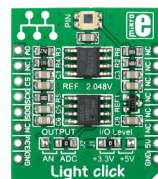

LightHz click™

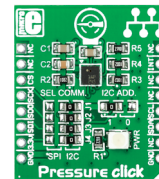

Pressure click™

11. Dimensions

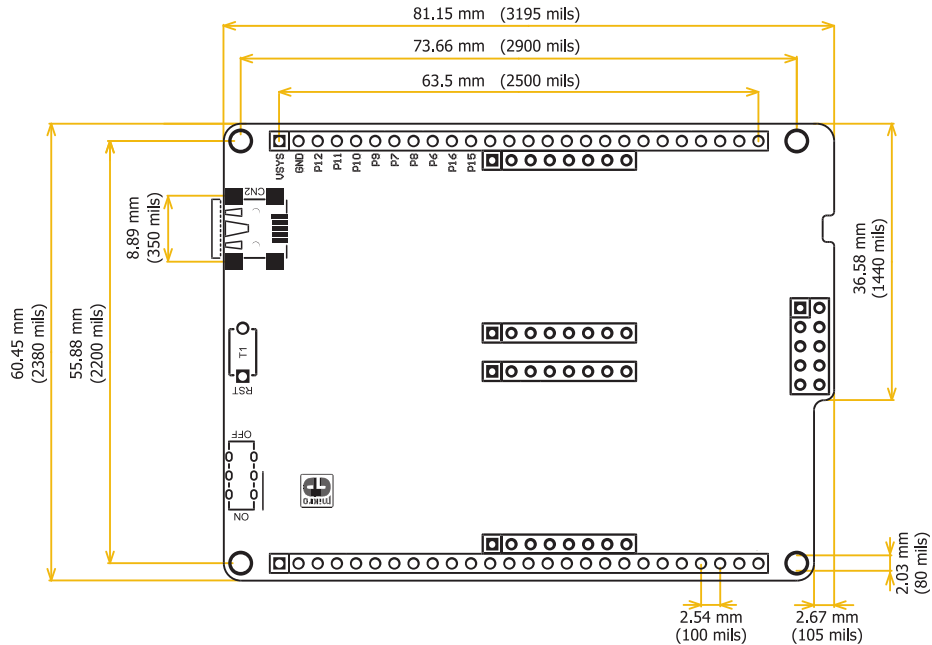

DISCLAIMER

All the products owned by MikroElektronika are protected by copyright law and international copyright treaty. Therefore, this manual is to be treated as any other copyright material. No part of this manual, including product and software described herein, may be reproduced, stored in a retrieval system, translated or transmitted in any form or by any means, without the prior written permission of MikroElektronika. The manual PDF edition can be printed for private or local use, but not for distribution. Any modification of this manual is prohibited. MikroElektronika provides this manual 'as is' without warranty of any kind, either expressed or implied, including, but not limited to, the implied warranties or conditions of merchantability or fitness for a particular purpose. MikroElektronika shall assume no responsibility or liability for any errors, omissions and inaccuracies that may appear in this manual. In no event shall MikroElektronika, its directors, officers, employees or distributors be liable for any indirect, specific, incidental or consequential damages (including damages for loss of business profits and business information, business interruption or any other pecuniary loss) arising out of the use of this manual or product, even if MikroElektronika has been advised of the possibility of such damages. MikroElektronika reserves the right to change information contained in this manual at any time without prior notice, if necessary.

HIGH RISK ACTIVITIES

The products of MikroElektronika are not fault – tolerant nor designed, manufactured or intended for use or resale as on – line control equipment in hazardous environments requiring fail – safe performance, such as in the operation of nuclear facilities, aircraft navigation or communication systems, air traffic control, direct life support machines or weapons systems in which the failure of Software could lead directly to death, personal injury or severe physical or environmental damage ('High Risk Activities'). MikroElektronika and its suppliers specifically disclaim any expressed or implied warranty of fitness for High Risk Activities.

TRADEMARKS

The MikroElektronika name and logo, mikroC™, mikroBasic™, mikroPascal™, Visual TFT™, Visual GLCD™, mikroProg™, Ready™, MINI™, mikroBUS™, EasyPIC™, EasyAVR™, Easy8051™, click™ boards and mikromedia™ are trademarks of MikroElektronika. All other trademarks mentioned herein are property of their respective companies. All other product and corporate names appearing in this manual may or may not be registered trademarks or copyrights of their respective companies, and are only used for identification or explanation and to the owners' benefit, with no intent to infringe.

The FTDI Chip® and Windows® logos and product names are trademarks of FTDI Chip and Microsoft® in the U.S.A. and other countries.

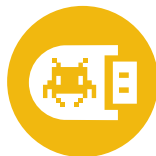

-
- If you want to learn more about our products, please visit our website at **www.mikroe.com**
 - If you are experiencing some problems with any of our products or just need additional information, please place your ticket at **www.mikroe.com/support**
 - If you have any questions, comments or business proposals, do not hesitate to contact us at **office@mikroe.com**
-

Clicker 2 for FT90x manual
ver 1.01a



Designed by
MikroElektronika Ltd.