



■ Features :

- Output current level selectable by DIP S.W.
- 180~295VAC input only
- Built-in active PFC function
- Protections: Short circuit / Over voltage / Over temperature
- Cooling by free air convection
- Fully isolated plastic case
- Class II power unit, no FG
- Built-in 0~10Vdc and PWM signal dimming function
- Built-in 12V/50mA auxiliary output
- Logarithm or linear dimming curve selectable(Meet IEC62386-207)
- Temperature compensation function by external NTC
- No load power consumption <1W(Note.7)
- Power supplies synchronization function up to 10 units
- Suitable for indoor LED lighting applications
- 3 years warranty



SPECIFICATION



| MODEL               |  | LCM-60   |         |              |         |         |         |
|---------------------|--|--|---------|--------------|---------|---------|---------|
| OUTPUT              | SELECTABLE CURRENT Note.3  | 500mA  | 600mA   | 700mA        | 900mA   | 1050mA  | 1400mA  |
|                     | DC VOLTAGE RANGE   | 2 ~ 90V  | 2 ~ 90V | 2 ~ 86V      | 2 ~ 67V | 2 ~ 57V | 2 ~ 42V |
|                     | RATED POWER  | 60.3W  |         |              |         |         |         |
|                     | RIPPLE CURRENT   | ± 5%   |         |              |         |         |         |
|                     | RIPPLE & NOISE (max.) Note.2   | 700mVp-p   |         |              |         |         |         |
|                     | NO LOAD OUTPUT VOLTAGE (max.)  | 95V  |         |              |         | 73V     |         |
|                     | CURRENT ACCURACY   | ± 5.0%   |         |              |         |         |         |
|                     | SETUP, RISE TIME Note.5  | 500ms, 80ms / 230VAC at rated power  |         |              |         |         |         |
| HOLD UP TIME (Typ.) | 16ms/230VAC at rated power   |  |         |              |         |         |         |
| INPUT               | VOLTAGE RANGE Note.4   | 180 ~ 295VAC   |         | 254 ~ 417VDC |         |         |         |
|                     | FREQUENCY RANGE  | 47 ~ 63Hz  |         |              |         |         |         |
|                     | POWER FACTOR (Typ.)  | PF ≥ 0.975/230VAC, PF ≥ 0.96/277VAC at rated power (Please refer to "Power Factor Characteristic" curve) |         |              |         |         |         |
|                     | TOTAL HARMONIC DISTORTION  | Total harmonic distortion will be lower than 20% when output loading is 75% or higher                    |         |              |         |         |         |
|                     | EFFICIENCY (Typ.) Note.6   | 92%  |         |              |         |         |         |
|                     | AC CURRENT (Typ.)  | 0.32A/230VAC   |         | 0.27A/277VAC |         |         |         |
|                     | INRUSH CURRENT(Typ.)   | COLD START 20A(twidth=270,µs measured at 50% Ipeak) at 230VAC  |         |              |         |         |         |
|                     | LEAKAGE CURRENT  | <0.5mA / 240VAC  |         |              |         |         |         |
| PROTECTION          | SHORT CIRCUIT  | Constant current limiting, recovers automatically after fault condition is removed                       |         |              |         |         |         |
|                     | OVER VOLTAGE   | 105 ~ 125V<br>Protection type : Shutdown o/p voltage, re-power on to recover                             |         |              |         |         |         |
|                     | OVER TEMPERATURE   | Shut down o/p voltage, re-power on to recover  |         |              |         |         |         |
| FUNCTION            | AUXILIARY POWER  | 12V @ 50mA for driving fan; Tolerance ± 5%   |         |              |         |         |         |
|                     | TEMP. COMPENSATION   | By external NTC(not provide with the power supply), please see "Temperature Compensation Operation"      |         |              |         |         |         |
|                     | DIMMING  | Please see "Dimming Operation"   |         |              |         |         |         |
|                     | SYNCHRONIZATION  | Please see "Synchronization Operation"   |         |              |         |         |         |
| ENVIRONMENT         | WORKING TEMP.  | -30 ~ +60°C (Refer to "Derating Curve")  |         |              |         |         |         |
|                     | WORKING HUMIDITY   | 20 ~ 90% RH non-condensing   |         |              |         |         |         |
|                     | STORAGE TEMP., HUMIDITY  | -40 ~ +80°C, 10 ~ 95% RH   |         |              |         |         |         |
|                     | TEMP. COEFFICIENT  | ± 0.03%/°C (0 ~ 50°C)  |         |              |         |         |         |
|                     | VIBRATION  | 10 ~ 500Hz, 2G 10min./1cycle, period for 60min. each along X, Y, Z axes                                  |         |              |         |         |         |
| SAFETY & EMC        | SAFETY STANDARDS   | UL8750, ENEC EN61347-1, EN61347-2-13, EN62384 independent approved                                       |         |              |         |         |         |
|                     | WITHSTAND VOLTAGE  | I/P-O/P:3.75KVAC   |         |              |         |         |         |
|                     | ISOLATION RESISTANCE   | I/P-O/P:>100M Ohms / 500VDC / 25°C / 70% RH  |         |              |         |         |         |
|                     | EMC EMISSION   | Compliance to EN55015, EN61000-3-2 Class C(≥ 40% rated power) ; EN61000-3-3                              |         |              |         |         |         |
|                     | EMC IMMUNITY   | Compliance to EN61000-4-2,3,4,5,6,8,11, EN55024, EN61547 light industry level (surge 2KV), criteria A    |         |              |         |         |         |
| OTHERS              | MTBF   | 260.6K hrs min. MIL-HDBK-217F (25°C)   |         |              |         |         |         |
|                     | DIMENSION  | 123.5*81.5*23mm (L*W*H)  |         |              |         |         |         |
|                     | PACKING  | 0.24Kg ; 54pcs/15Kg/1.12CUFT   |         |              |         |         |         |
| NOTE                | <ol style="list-style-type: none"> <li>1. All parameters NOT specially mentioned are measured at 230VAC input, rated load and 25°C of ambient temperature.</li> <li>2. Ripple &amp; noise are measured at 20MHz of bandwidth by using a 12" twisted pair-wire terminated with a 0.1uf parallel capacitor.</li> <li>3. Please see "DIP switch table".</li> <li>4. Derating may be needed under low input voltage. Please check the static characteristics for more details.</li> <li>5. Length of set up time is measured at first cold start. Turning ON/OFF the power supply may lead to increase of the set up time.</li> <li>6. Efficiency is measured at 900mA/67V output set by DIP switch.</li> <li>7. No load power consumption&lt;1W is measured at 180~277VAC, with lighting fixture connected and output current dimmed to 0%.</li> <li>8. The power supply is considered as a component that will be operated in combination with final equipment. Since EMC performance will be affected by the complete installation, the final equipment manufacturers must re-qualify EMC Directive on the complete installation again.</li> <li>9. To fulfill requirements of the latest ErP regulation for lighting fixtures, this LED power supply can only be used behind a switch without permanently connected to the mains.</li> </ol> |  |         |              |         |         |         |

**Mechanical Specification**

Case No. LCM-60A Unit:mm

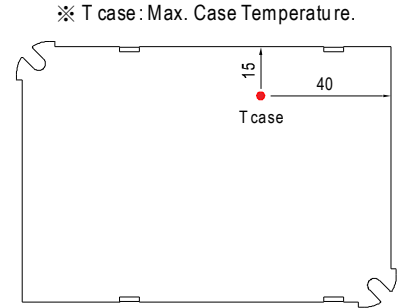
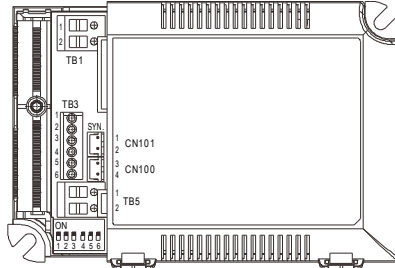
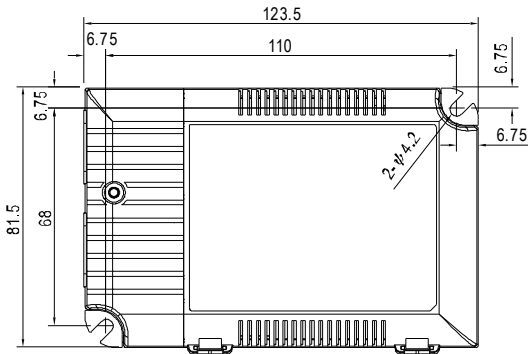

※ T case : Max. Case Temperature.

Bottom View

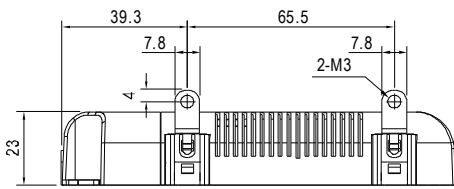

Terminal Pin No. Assignment(TB1)

| Pin No. | Assignment |
|---------|------------|
| 1       | AC/L       |
| 2       | AC/N       |

Terminal Pin No. Assignment(TB3)

| Pin No. | Assignment | Pin No. | Assignment |
|---------|------------|---------|------------|
| 1       | +FAN       | 4       | -NTC       |
| 2       | -FAN       | 5       | DIM+       |
| 3       | +NTC       | 6       | DIM-       |

Terminal Pin No. Assignment(TB5)

| Pin No. | Assignment |
|---------|------------|
| 1       | +Vo        |
| 2       | -Vo        |

SYN. Connector(CN101/CN100): JST B2B-XH or equivalent

| Pin No. | Assignment | Mating Housing        | Terminal                        |
|---------|------------|-----------------------|---------------------------------|
| 1,3     | +          | JST XHP or equivalent | JST SXH-001T-P0.6 or equivalent |
| 2,4     | -          |                       |                                 |

PFC fosc : 60KHz  
PWM fosc : 80KHz

**Block Diagram**

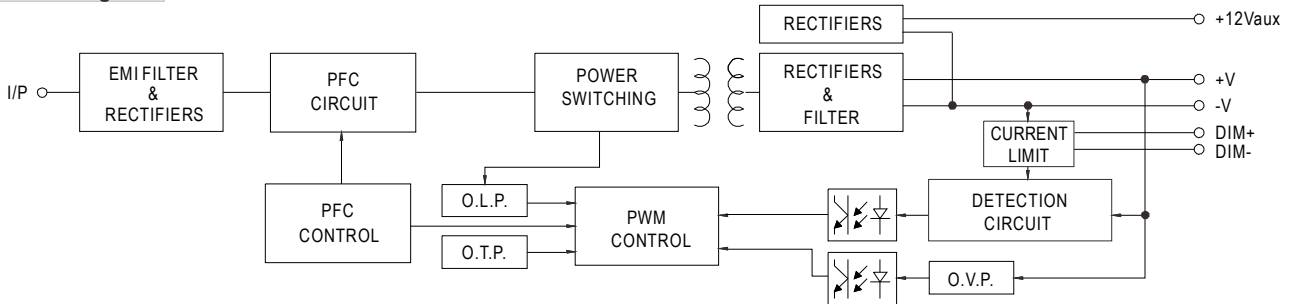

**Derating Curve**

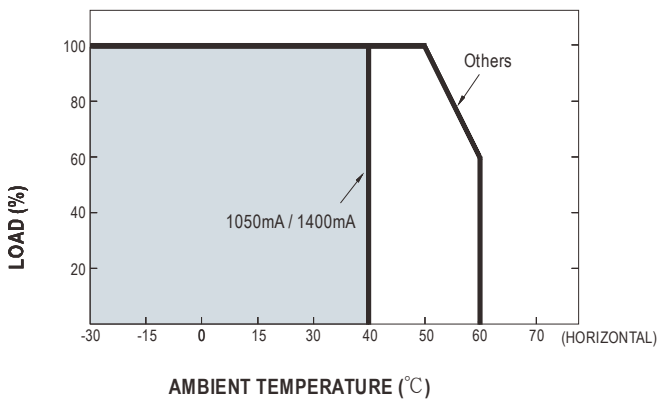

**Static Characteristics**

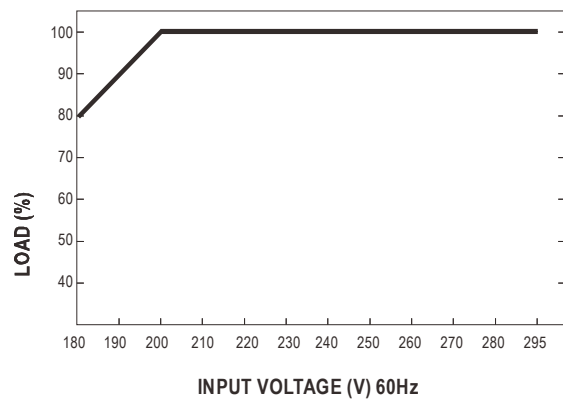

**DIP Switch Table**

LCM-60 is a multiple-stage output current supply, selection of output current through DIP switch as table below.

| Io \ DIP S.W.          | 1    | 2    | 3    | 4    | 5    | 6    |
|------------------------|------|------|------|------|------|------|
| 500mA                  | ---- | ---- | ---- | ---- | ---- | ---- |
| 600mA                  | ON   | ---- | ---- | ---- | ---- | ---- |
| 700mA(Factory Setting) | ON   | ON   | ---- | ---- | ---- | ---- |
| 900mA                  | ON   | ON   | ON   | ---- | ---- | ON   |
| 1050mA                 | ON   | ON   | ON   | ON   | ---- | ON   |
| 1400mA                 | ON   | ON   | ON   | ON   | ON   | ON   |

**Power Factor Characteristic**

Constant Current Mode

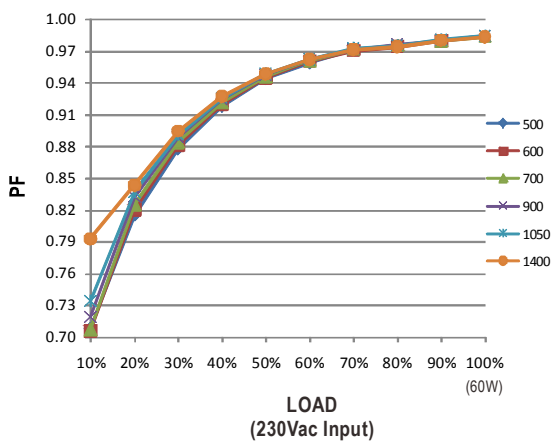

Constant Current Mode

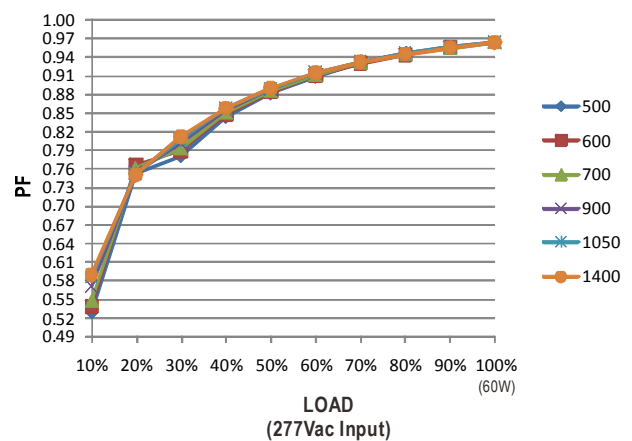

**EFFICIENCY vs LOAD**

LCM-60 series possess superior working efficiency that up to 92% can be reached in field applications.

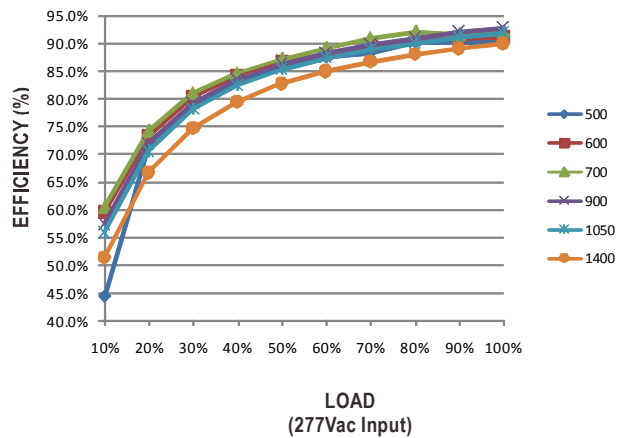
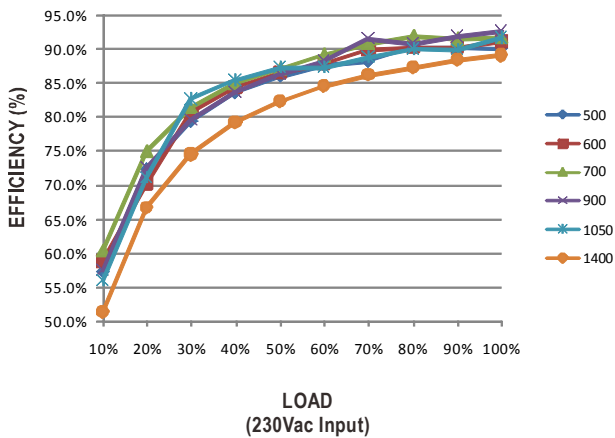

**■ DIMMING OPERATION**

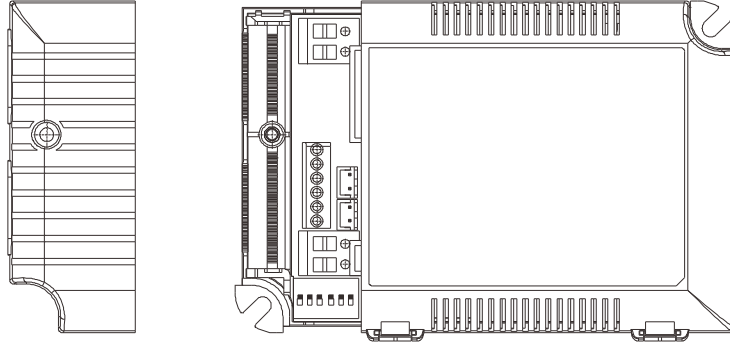

※ Built-in 2 in 1 dimming function, output constant current level can be adjusted through output terminal by 0 ~ 10Vdc or 10V PWM signal between DIM+ and DIM-.

※ Please DO NOT connect "DIM-" to "-Vo".

※ 0 ~ 10V dimming function for output current adjustment (Typical)

|                |    |     |     |     |     |     |     |     |     |     |      |           |
|----------------|----|-----|-----|-----|-----|-----|-----|-----|-----|-----|------|-----------|
| Dimming value  | 0V | 1V  | 2V  | 3V  | 4V  | 5V  | 6V  | 7V  | 8V  | 9V  | 10V  | OPEN      |
| Output current | 0% | 10% | 20% | 30% | 40% | 50% | 60% | 70% | 80% | 90% | 100% | 100%~108% |

※ 10V PWM signal for output current adjustment (Typical): Frequency range :100Hz ~ 3KHz

|                |    |     |     |     |     |     |     |     |     |     |      |           |
|----------------|----|-----|-----|-----|-----|-----|-----|-----|-----|-----|------|-----------|
| Duty value     | 0% | 10% | 20% | 30% | 40% | 50% | 60% | 70% | 80% | 90% | 100% | OPEN      |
| Output current | 0% | 10% | 20% | 30% | 40% | 50% | 60% | 70% | 80% | 90% | 100% | 100%~108% |

**■ SYNCHRONIZATION OPERATION**

- 10 drivers(max.) synchronization (1 master + 9 slaves)
- Maximum cable length between each units : 20 meter.

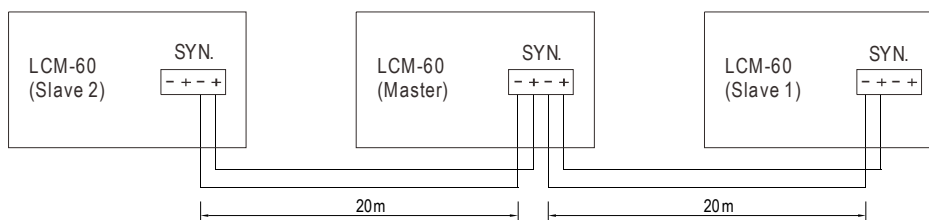

■ TEMPERATURE COMPENSATION OPERATION

NTC derating curve

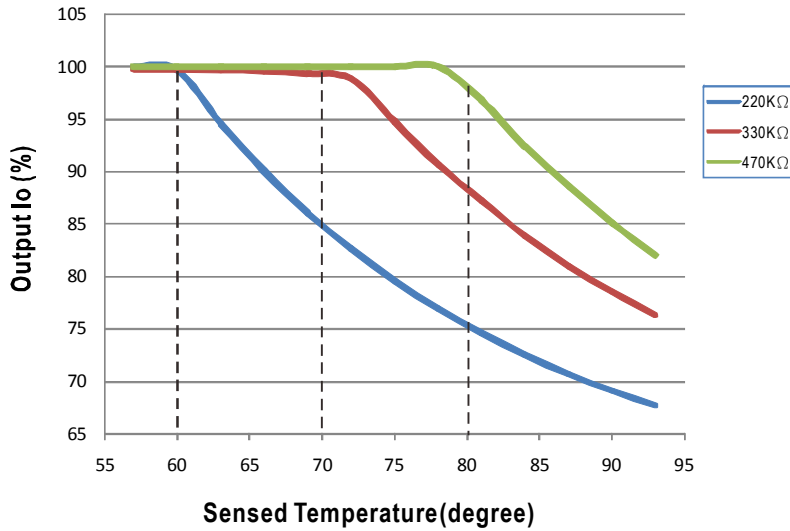

LCM-60 have the built-in temperature compensation function ( $T \uparrow, I_o \downarrow$ ). By connecting a temperature sensor (NTC resistor) between the NTC +/- terminal of LCM-60 and the detecting point on the lighting system or the surrounding environment, output current of LCM-60 could be correspondingly changed to ensure the long life of LED.

- 1.LCM-60 can still be operated well when the NTC resistor is not connected and the value of output current will be the current level that you set through the DIP switch.
- 2.

| NTC resistance | Output Current   |
|----------------|--|
| 220K           | < 60°C, 100% of the rated current (corresponds to the setting current level)<br>> 60°C, output current begin to reduce, details please refer to the curve. |
| 330K           | < 70°C, 100% of the rated current (corresponds to the setting current level)<br>> 70°C, output current begin to reduce, details please refer to the curve. |
| 470K           | < 80°C, 100% of the rated current (corresponds to the setting current level)<br>> 80°C, output current begin to reduce, details please refer to the curve. |

- Notes: 1. MW does not offer the NTC resistor and all the data above are measured by using THINKING TTC03 series.  
2. If other brands of NTC resistor is applied, please check the temperature curve first.