

DETAILS

Product Number	C13301_STRADA-2X2-T3
Family	Strada-Module
Type	Lens array
Color	clear
Diameter	50 x 50 mm
Height	7.1 mm
Style	square
Optic Material	PMMA
Holder Material	
Fastening	screw, pin, glue
Status	ready
ROHS Compliant	Yes
Date Updated	31/03/2015



OPTICAL PROPERTIES

LED	Viewing Angle	Light Beam	Efficiency	cd/lm	Connector
LH351B	Asymmetric deg	Asymmetric	94 %	0.560	-
TL1L3	Asymmetric deg	Asymmetric	94 %	0.480	-
LUXEON H50-2	sim: Asymmetric	Asymmetric	-	sim: 0.000	-
LUXEON Q	Asym deg	Asymmetric	94 %	0.700	-
Fortimo FastFlex LED board 2x8/740 DA	Asymmetric deg	Asymmetric	94 %	0.610	-
LUXEON T	Asymmetric deg	Asymmetric	94 %	0.670	-
Z5M1/Z5M2	Asym deg	Asymmetric	94 %	0.700	-
XP-G	Asymmetric deg	Asymmetric	94 %	0.700	-
XB-D	Asymmetric deg	Asymmetric	-	sim: 0.000	-
XM-L	Asymmetric deg	Asymmetric	-	sim: 0.000	-
Oslon Square PC	Asymmetric deg	Asymmetric	94 %	0.690	-
XT-E	Asymmetric deg	Asymmetric	94 %	0.730	-
LUXEON Rebel ES	Asymmetric deg	Asymmetric	94 %	0.720	-
LUXEON R	Asymmetric deg	Asymmetric	94 %	0.740	-
Z5P	Asymmetric deg	Asymmetric	94 %	0.720	-
NCSxx19A	Asymmetric deg	Asymmetric	-	sim: 0.000	-
NVSxx19A	Asymmetric deg	Asymmetric	-	sim: 0.000	-
XM-L2	Asymmetric deg	Asymmetric	94 %	0.540	-
XP-G2	Asymmetric deg	Asymmetric	92 %	0.680	-
LUXEON TX	Asym deg	Asymmetric	94 %	0.660	-
NS9x383	Asymmetric deg	Asymmetric	95 %	0.600	-
LH351A(3535)	Asymmetric deg	Asymmetric	94 %	0.750	-
NVSxx19B/NVSxx19C	Asymmetric deg	Asymmetric	94 %	0.710	-
LUXEON MZ	sim: Asym	Asymmetric	sim: 92 %	sim: 0.000	-
Oslon SSL 80	Asymmetric deg	Asymmetric	94 %	0.580	-

D C B A

4

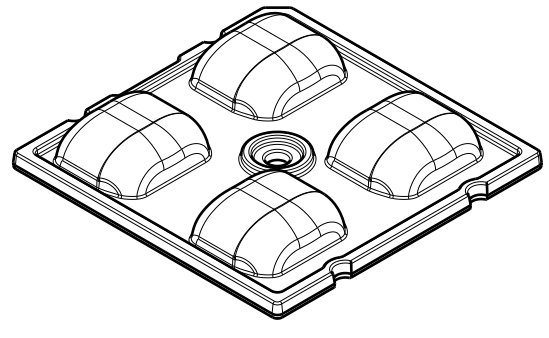
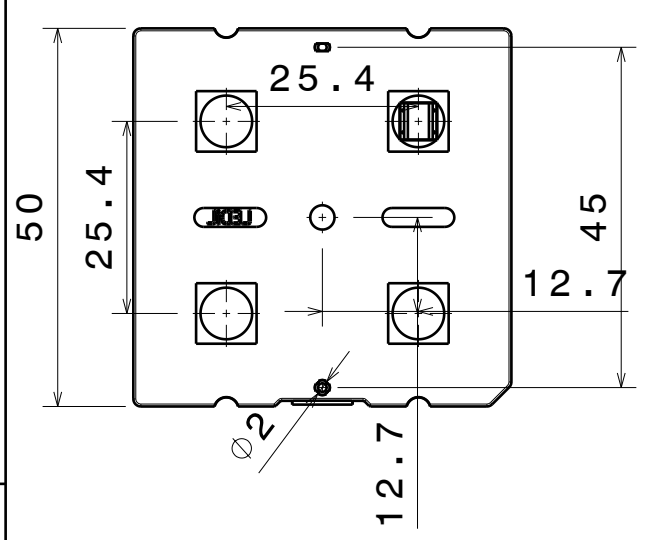

3

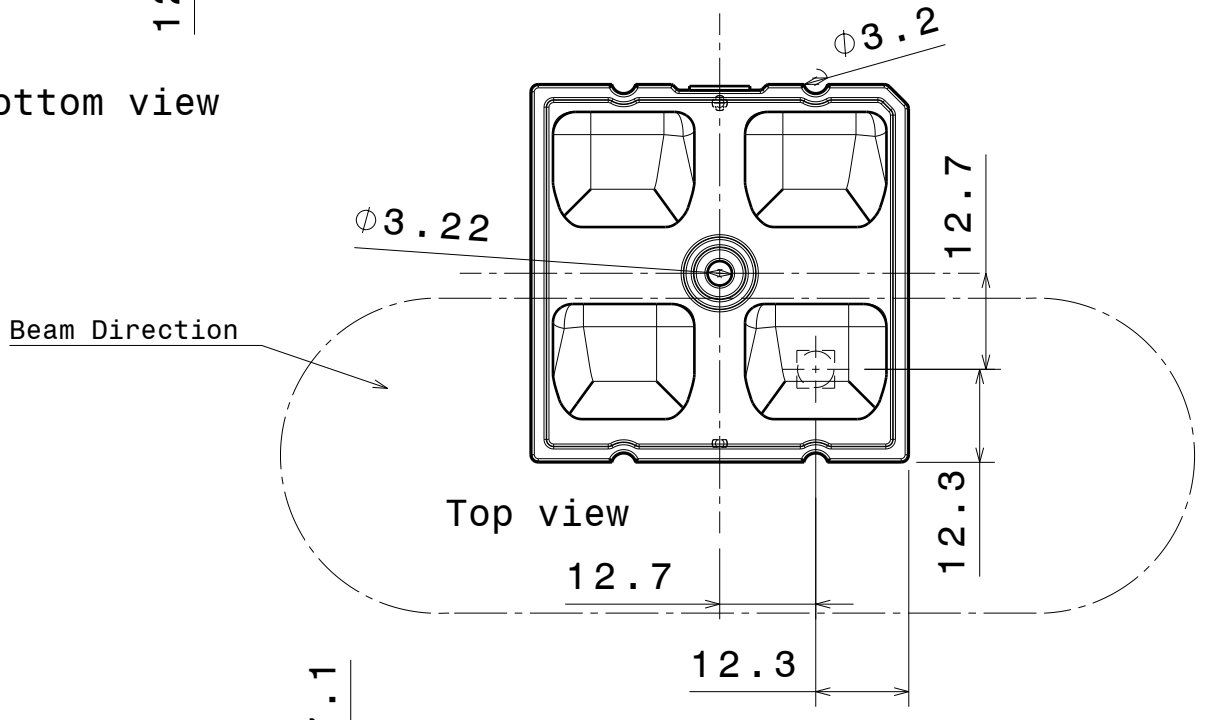

2

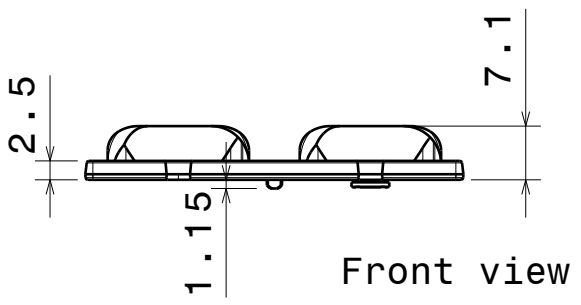

4

3

2

INDEX	PART NO	DESCRIPTION	MATERIAL	COLOUR
1	C13301	STRADA-2X2-T3	PMMA	

Tolerances if not otherwise shown
According to DIN ISO 2768-1
Linear measures:
Up to 30mm class M, otherwise class C.
According to DIN ISO 2768-2
Form and position: class L

LEDiL LediL Oy
Salorankatu 10
FIN 24240 SALO
Finland

THIRD ANGLE PROJECTION:

DRAWING TITLE
STRADA-2X2-T3

1

This drawing is the property of LEDiL Oy. It may not be reproduced, copied or communicated without a written agreement with LEDiL Oy."

SIZE	C13301		
A4			

1

SCALE	1:1	WEIGHT		SHEET	1/1
-------	-----	--------	--	-------	-----

D

A

Luminaire: LEDiL Oy C13301_STRADA-2X2-T3_(LH351B)

Lamps: 1 x SAMSUNG_LH351B_2x2_442.67lm@250mA_P=2.84311W_I=249.9mA

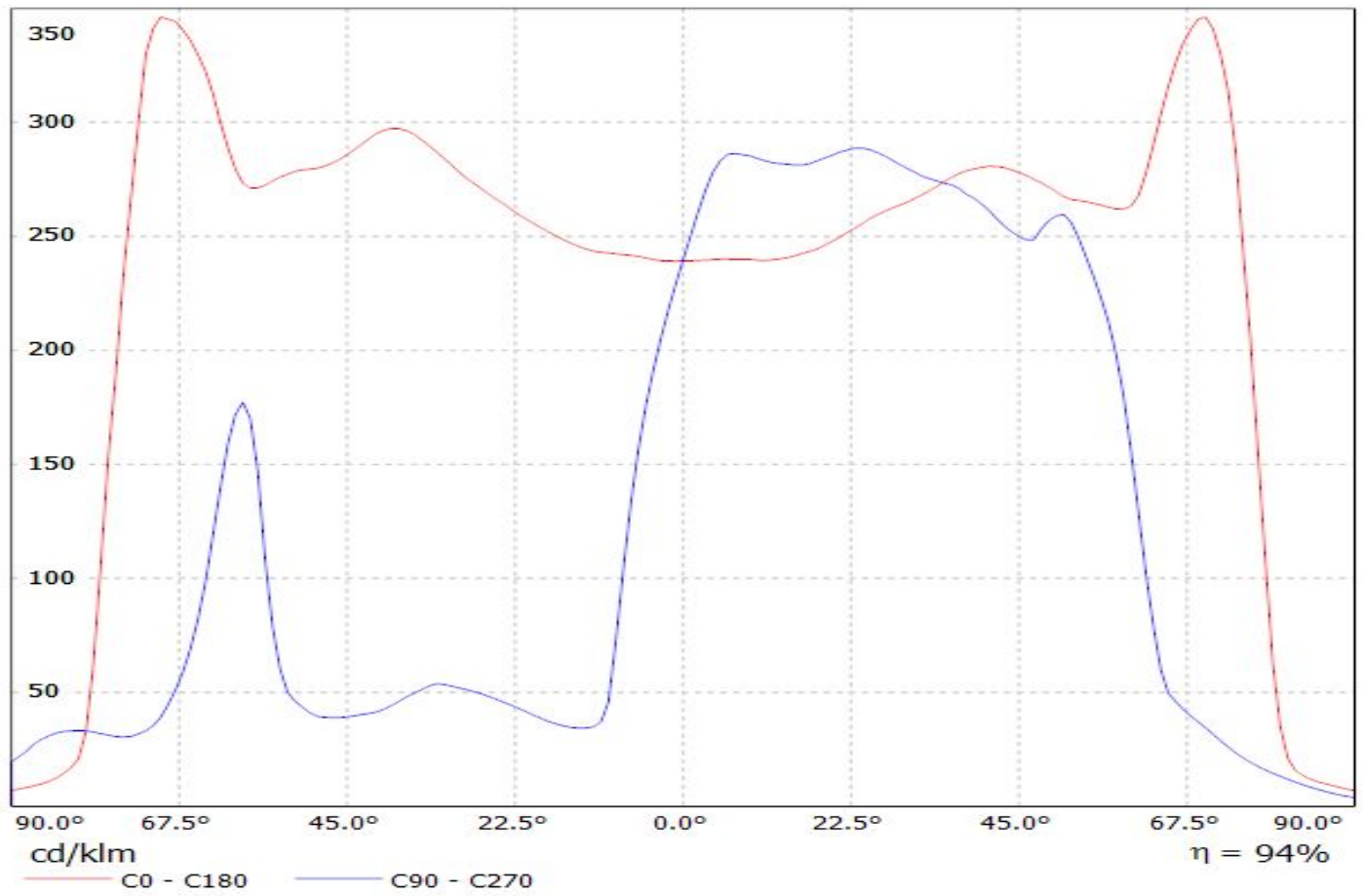

Ledil C13301_STRADA-2X2-T3_(TL1L3) / LDC (Linear)

Luminaire: Ledil C13301_STRADA-2X2-T3_(TL1L3)

Lamps: 1 x Toshiba_TL1L3_2x2_(TL1L3-NW1.L)_387.773lm@250mA_CCT=5000K_P=2.829W_I=0.25A

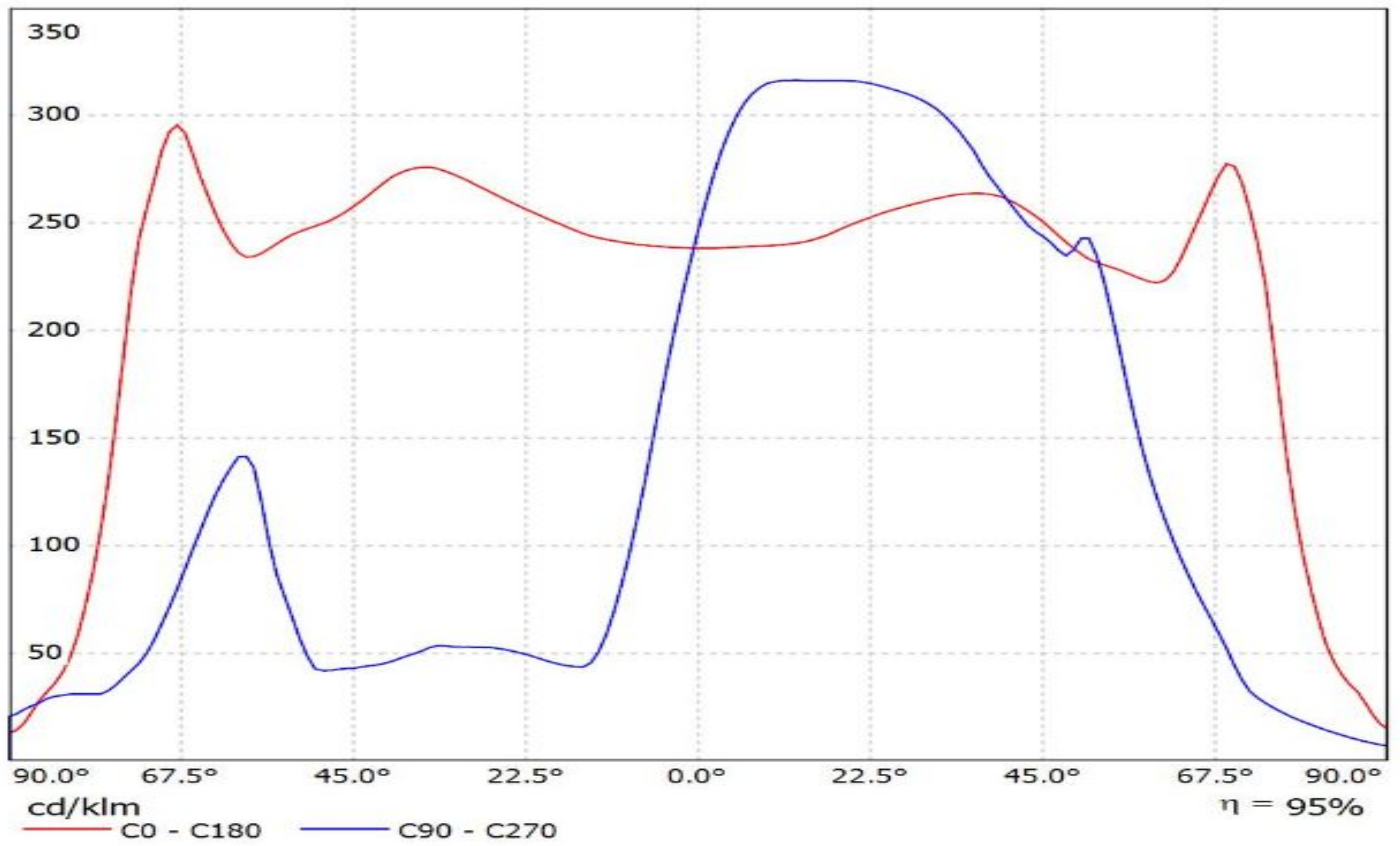

Luminaire: LEDiL Oy C13301_STRADA-2X2-T3_(LUXEON_Q)

Lamps: 1 x LUXEON_Q_2x2_(LHQ-3080)_299.038lm@250mA_P=2.8742W_I=249.8mA

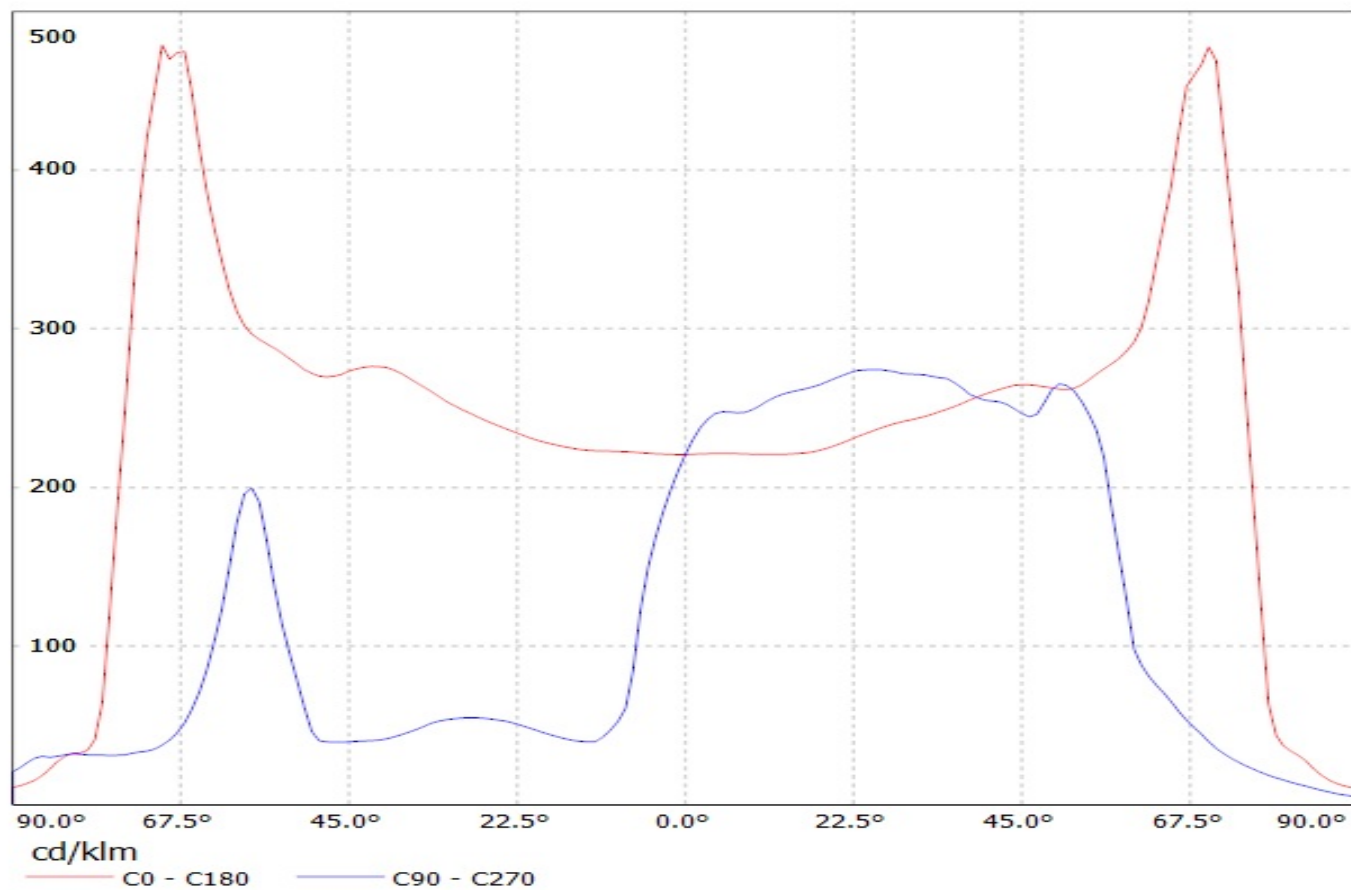

Luminaire: LEDiL Oy C13301_STRADA-2X2-T3_(Fortimo_F-Flex_2x8_740DAG3)

Lamps: 1 x Philips_Fortimo_F-Flex_2x8_740DAG3_1786.86lm@250mA_P=11.6092W_I=0.2498A

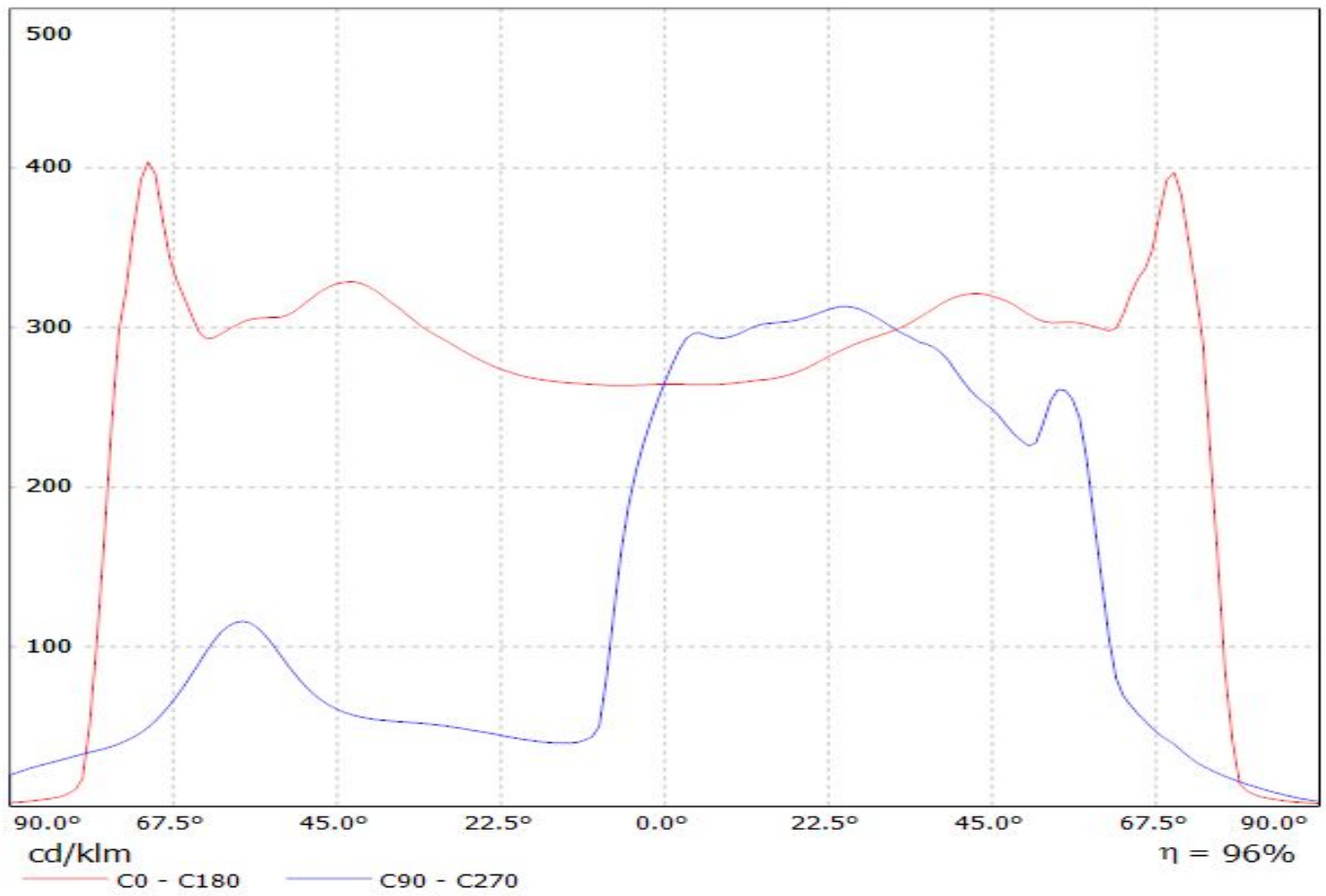

LEDiL Oy C13301_STRADA-2x2-T3_(LUXEON_T) Eff.93.9% / LDC (Linear)

Luminaire: LEDiL Oy C13301_STRADA-2x2-T3_(LUXEON_T) Eff.93.9%

Lamps: 1 x LUXEON_T (294lm@250mA)

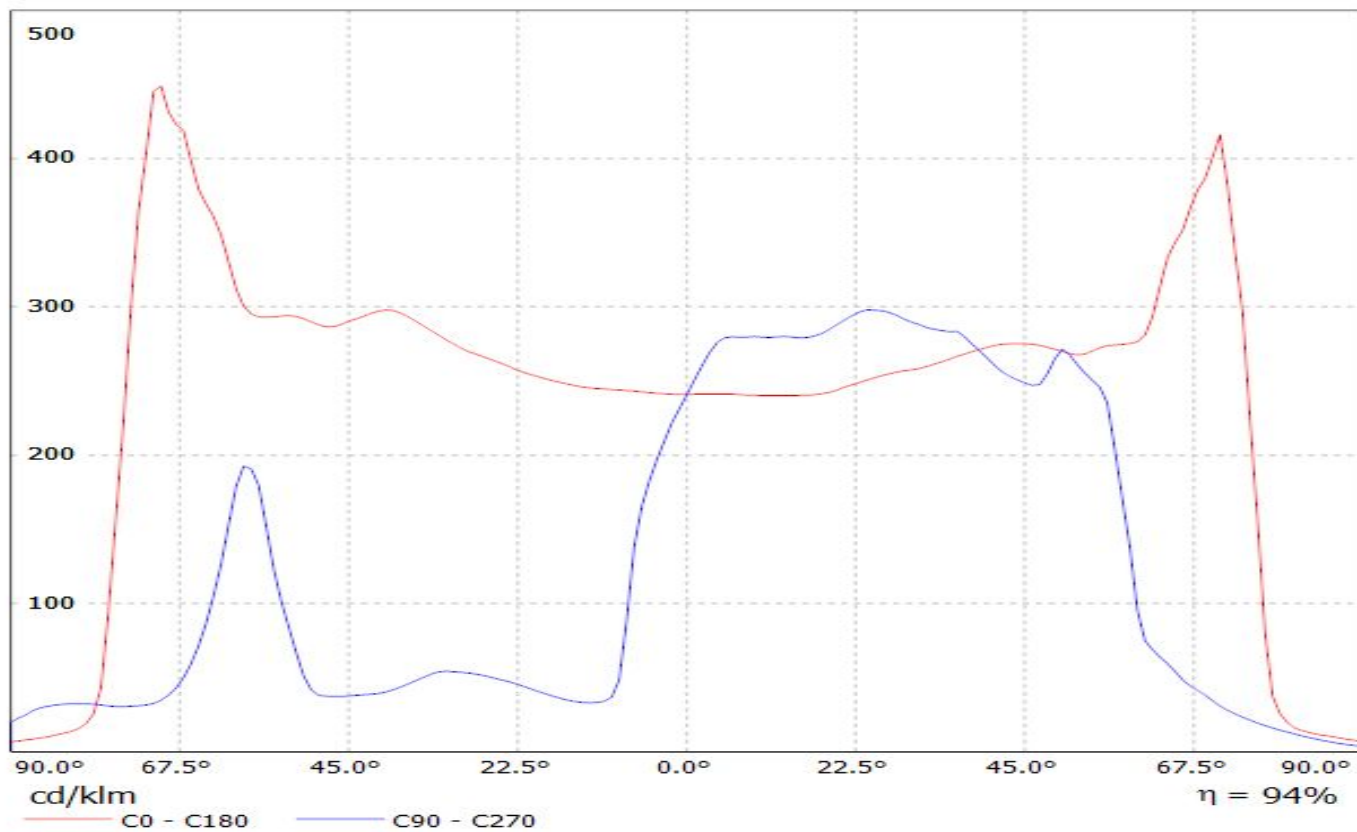

Luminaire: LEDil Oy C13301_STRADA-2X2-T3_(Z5M1) Efficiency=94%
Lamps: 1 x Seoul Z5M1 (SZ5-M1-WN-C8) 379lm @ 250mA CCT=4600K P=2.9W I=250mA

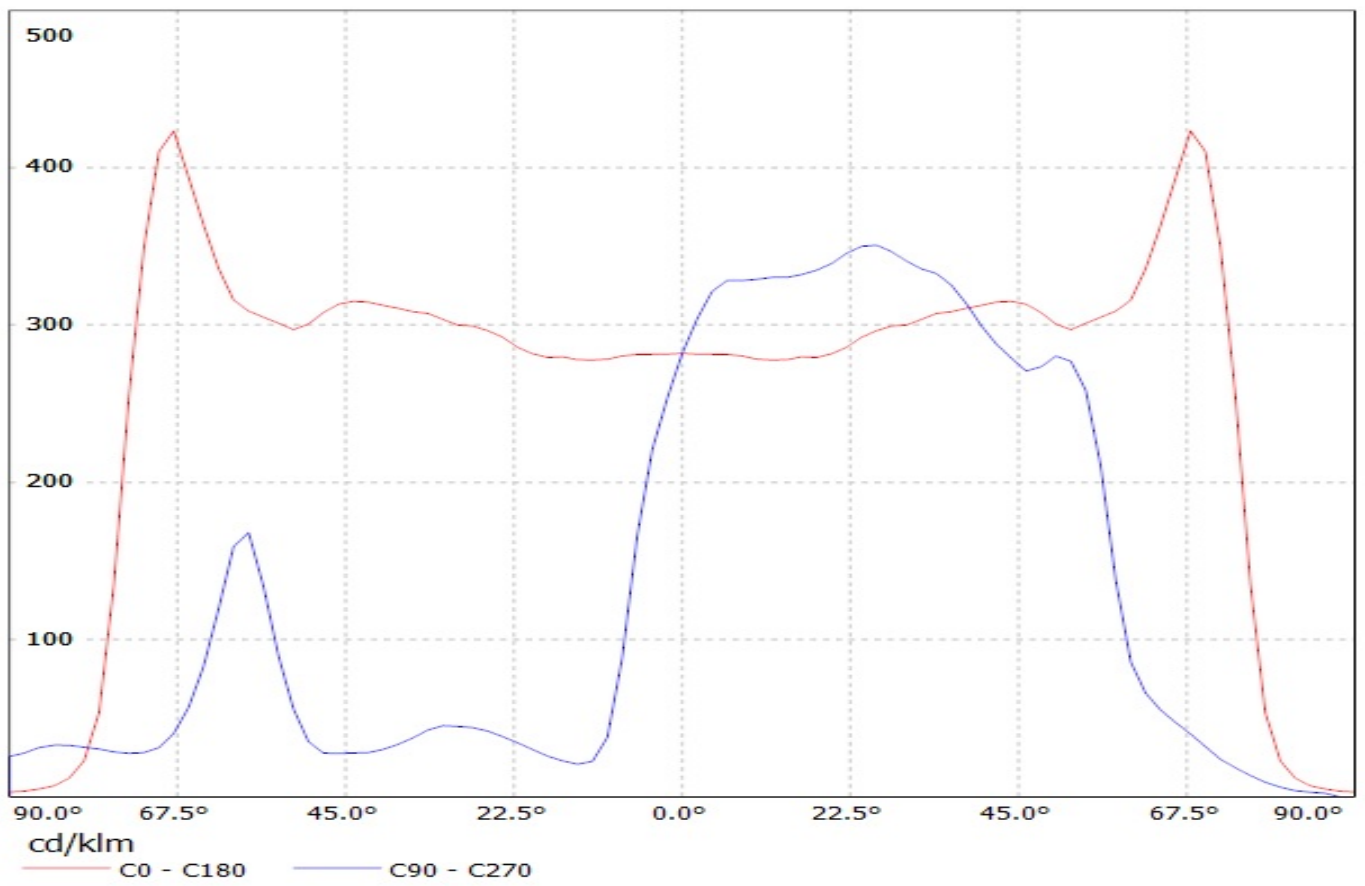

LEDiL Oy C13301_STRADA-2X2-T3_(XP-G) Eff.94.2% / LDC (Linear)

Luminaire: LEDiL Oy C13301_STRADA-2X2-T3_(XP-G) Eff.94.2%
Lamps: 1 x CREE XP-G2 (259lm@250mA)

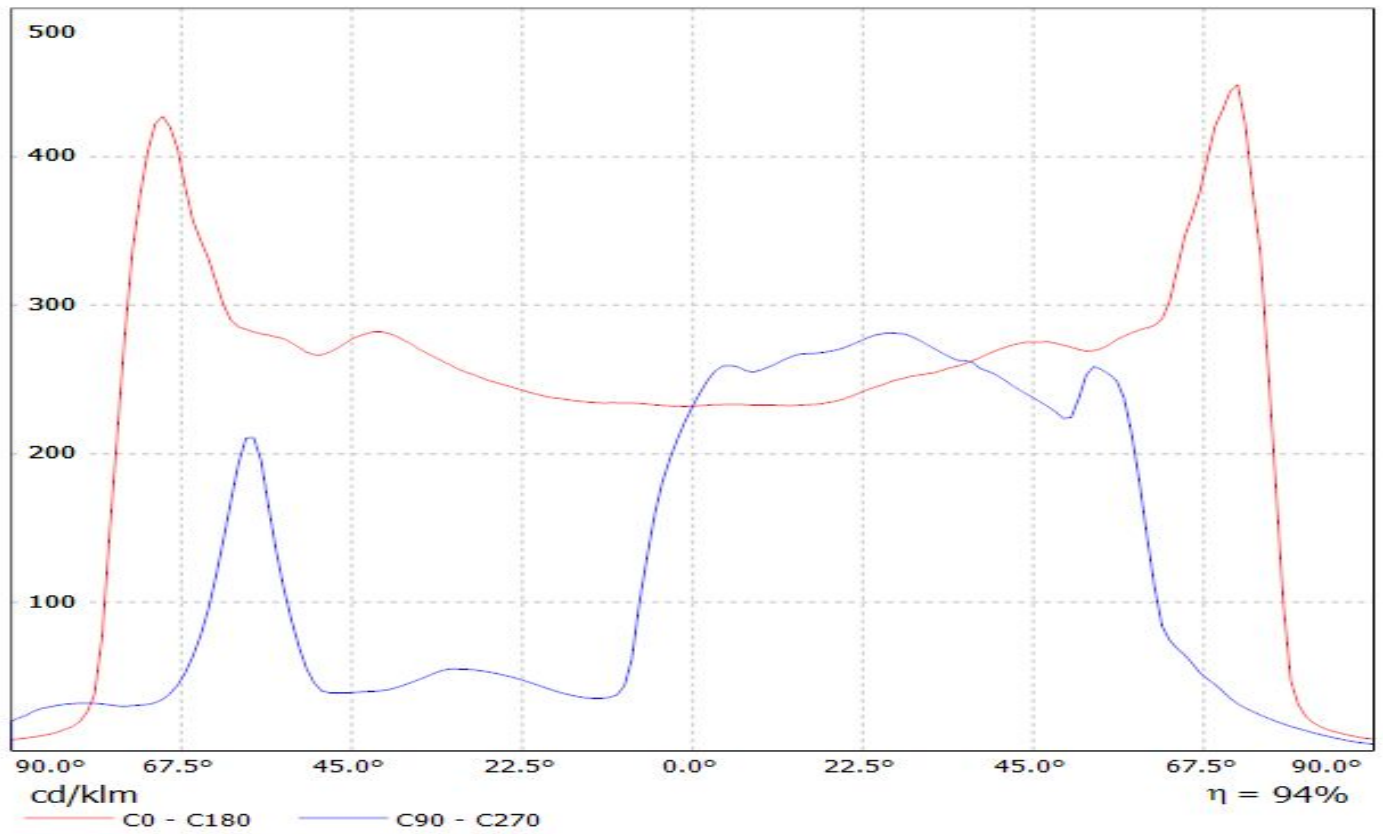

LEDiL Oy C13301_STRADA-2X2-T3_(SQ-PC) Eff.94.3% / LDC (Linear)

Luminaire: LEDiL Oy C13301_STRADA-2X2-T3_(SQ-PC) Eff.94.3%

Lamps: 1 x Oslon Square PC (399lm@250mA)

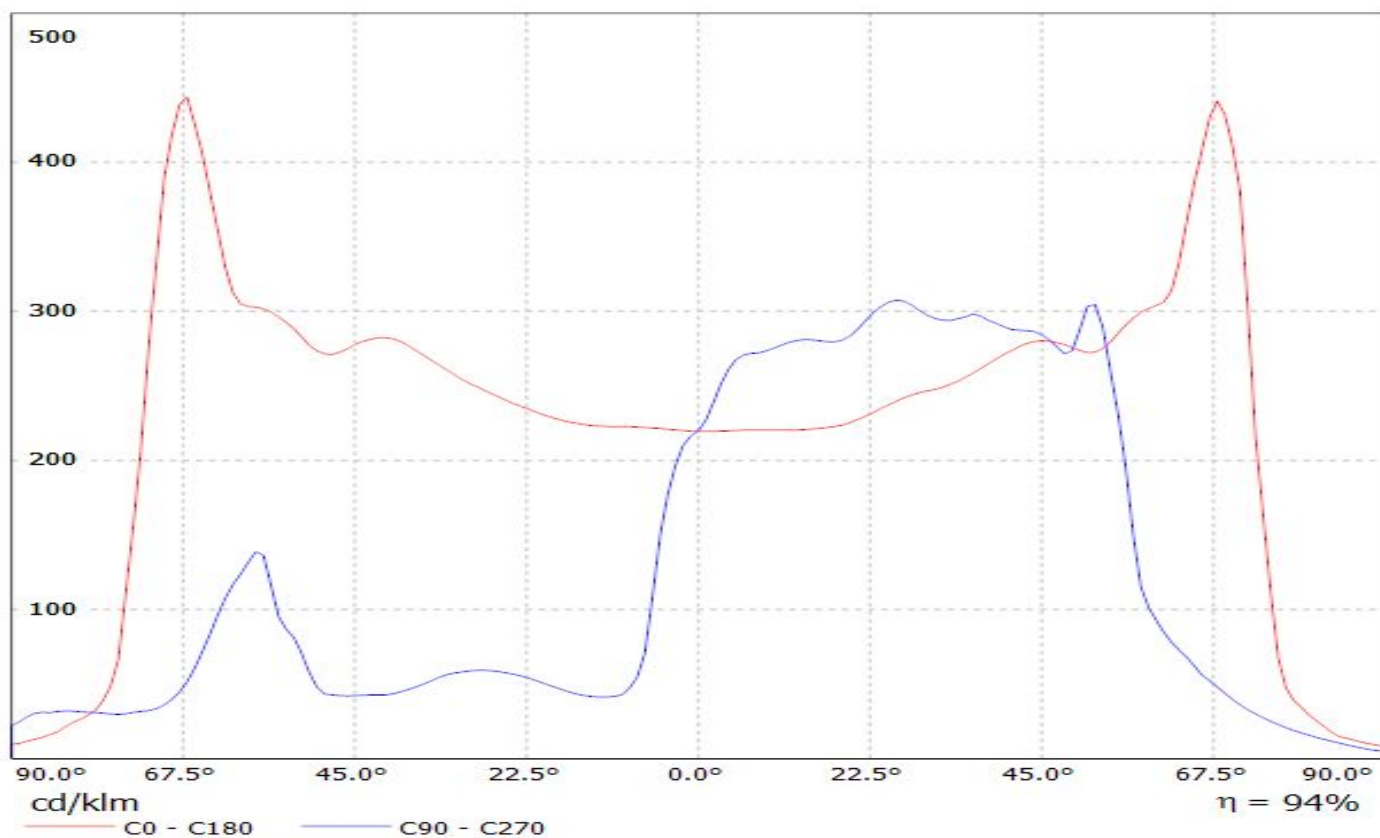

LEDiL Oy C13301_STRADA-2X2-T3_(XT-E) 95.0% / LDC (Linear)

Luminaire: LEDiL Oy C13301_STRADA-2X2-T3_(XT-E) 95.0%
Lamps: 1 x CREE_XT-E (390lm@250mA)

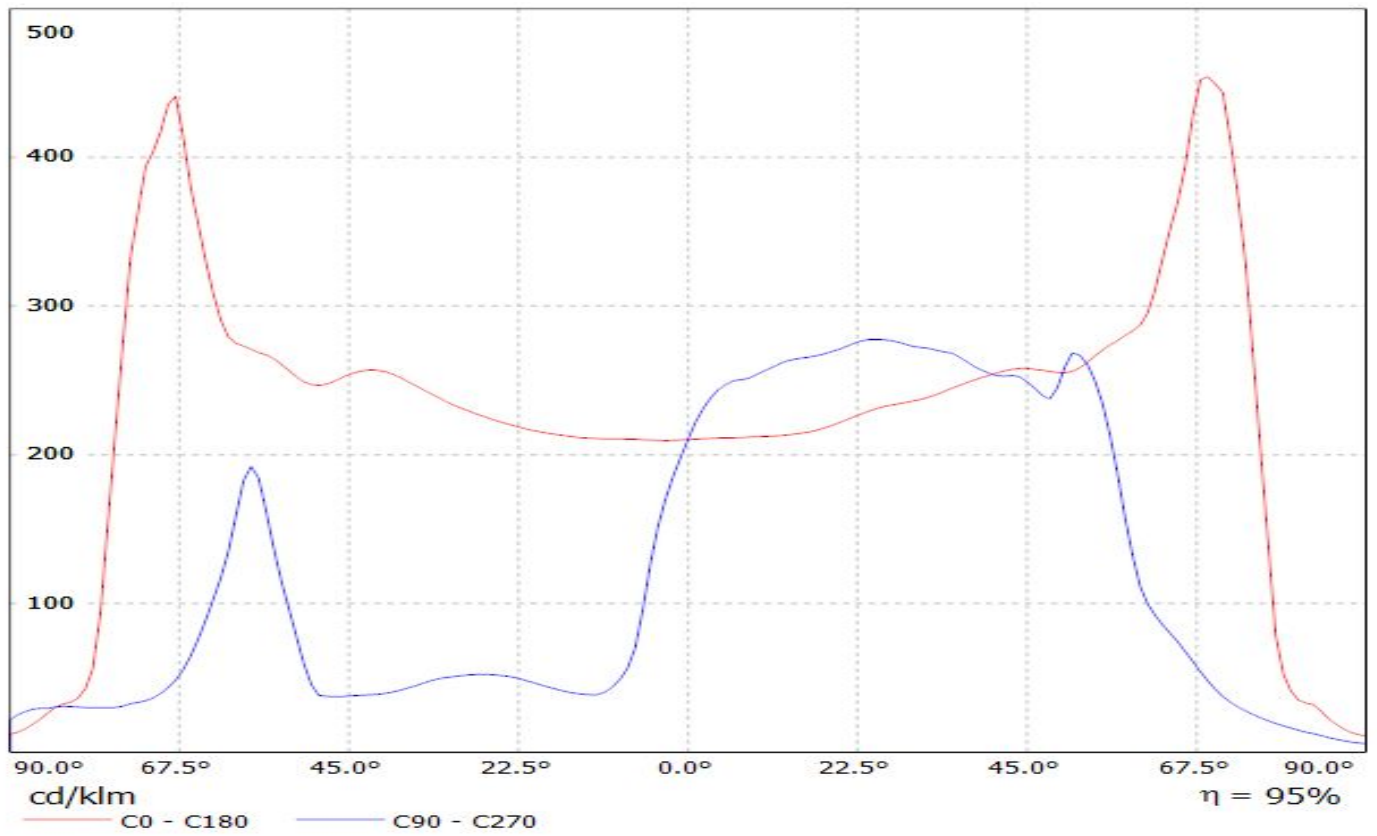

LEDiL Oy C13301_STRADA-2X2-T3_(Rebel-ES) Eff.94.1% / LDC (Linear)

Luminaire: LEDiL Oy C13301_STRADA-2X2-T3_(Rebel-ES) Eff.94.1%
Lamps: 1 x Rebel-ES (341lm@250mA)

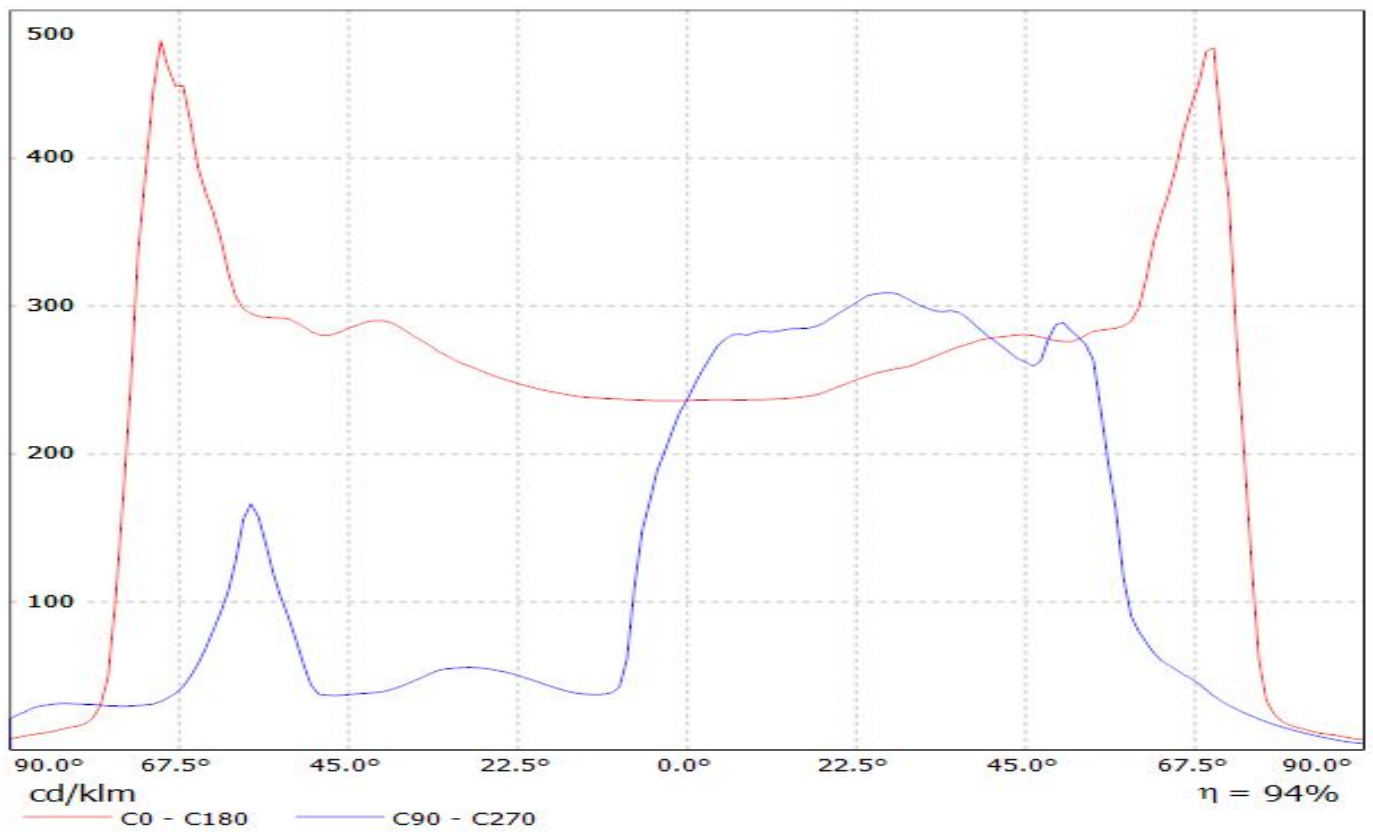

LEDiL Oy C13300_STRADA-2X2-T2_(LUXEON_R) Eff.94.4% / LDC (Linear)

Luminaire: LEDiL Oy C13300_STRADA-2X2-T2_(LUXEON_R) Eff.94.4%
Lamps: 1 x LUXEON_R (315lm@250mA)

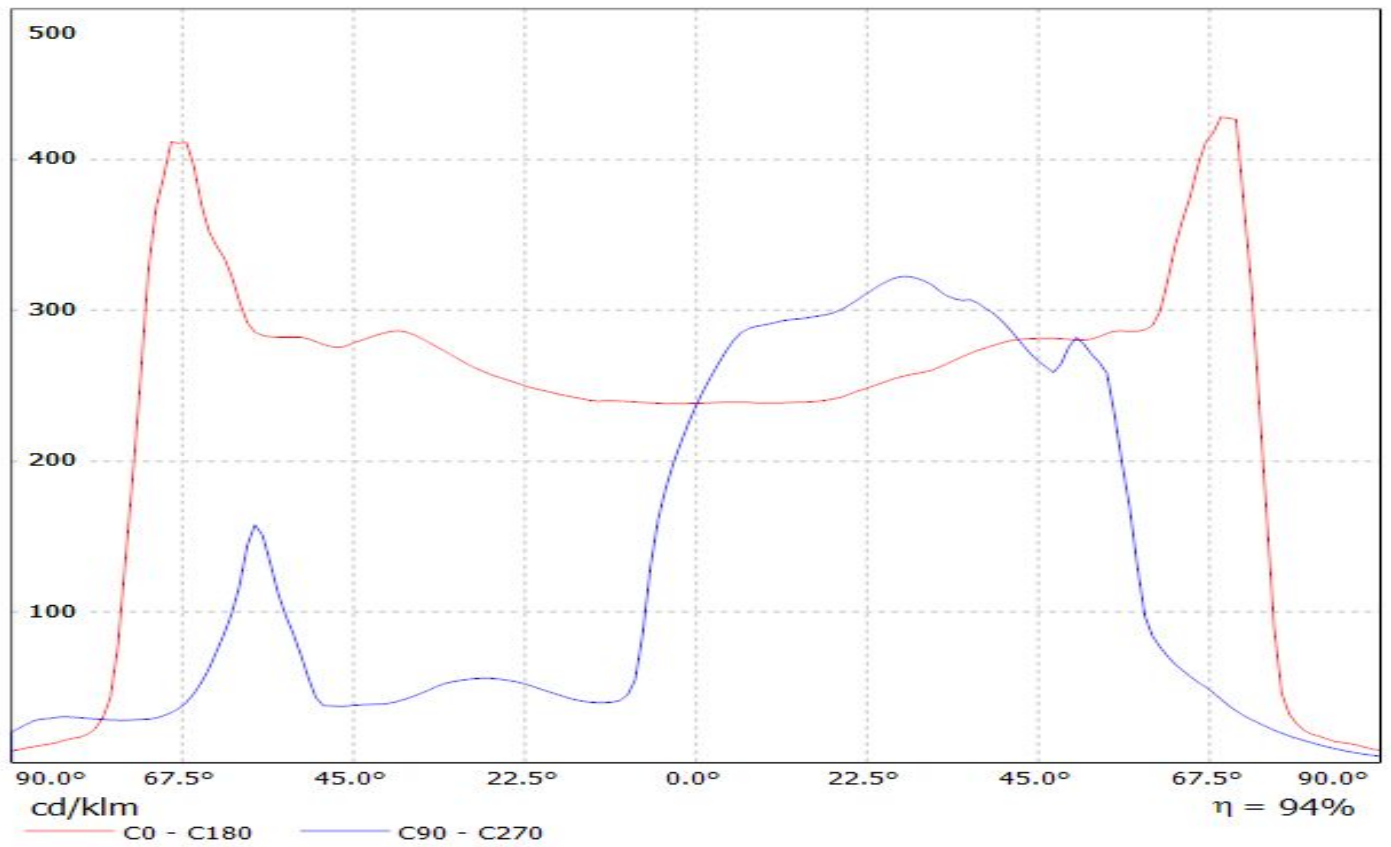

LEDiL Oy C13301_STRADA-2X2-T3_(Z5P) Eff.94.3% / LDC (Linear)

Luminaire: LEDiL Oy C13301_STRADA-2X2-T3_(Z5P) Eff.94.3%

Lamps: 1 x Seoul Z5P (290lm@250mA)

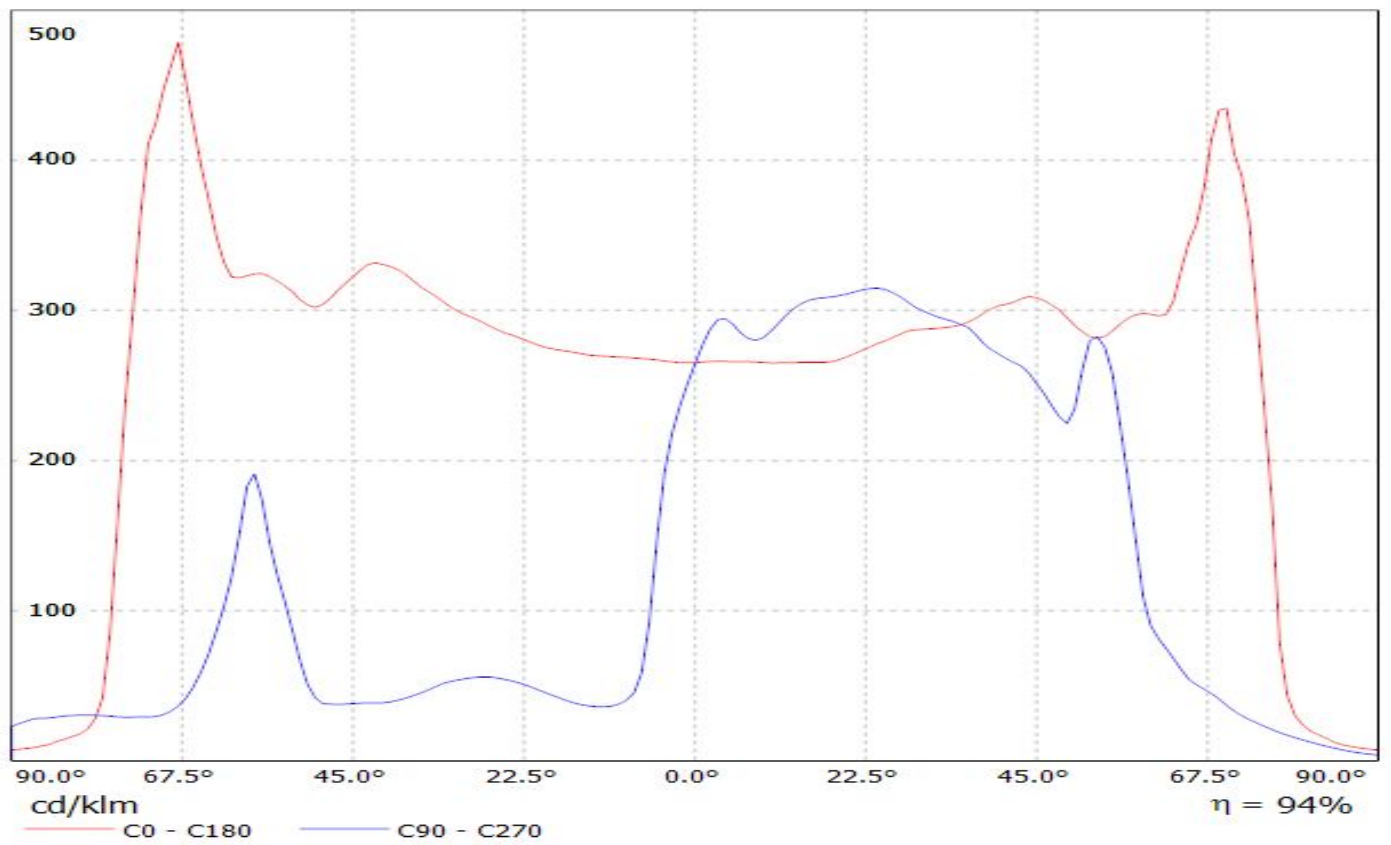

LEDiL Oy C13301_STRADA-2X2-T3_(XM-L2) Eff.94.3% / LDC (Linear)

Luminaire: LEDiL Oy C13301_STRADA-2X2-T3_(XM-L2) Eff.94.3%

Lamps: 1 x XM-L2 (366lm@250mA)

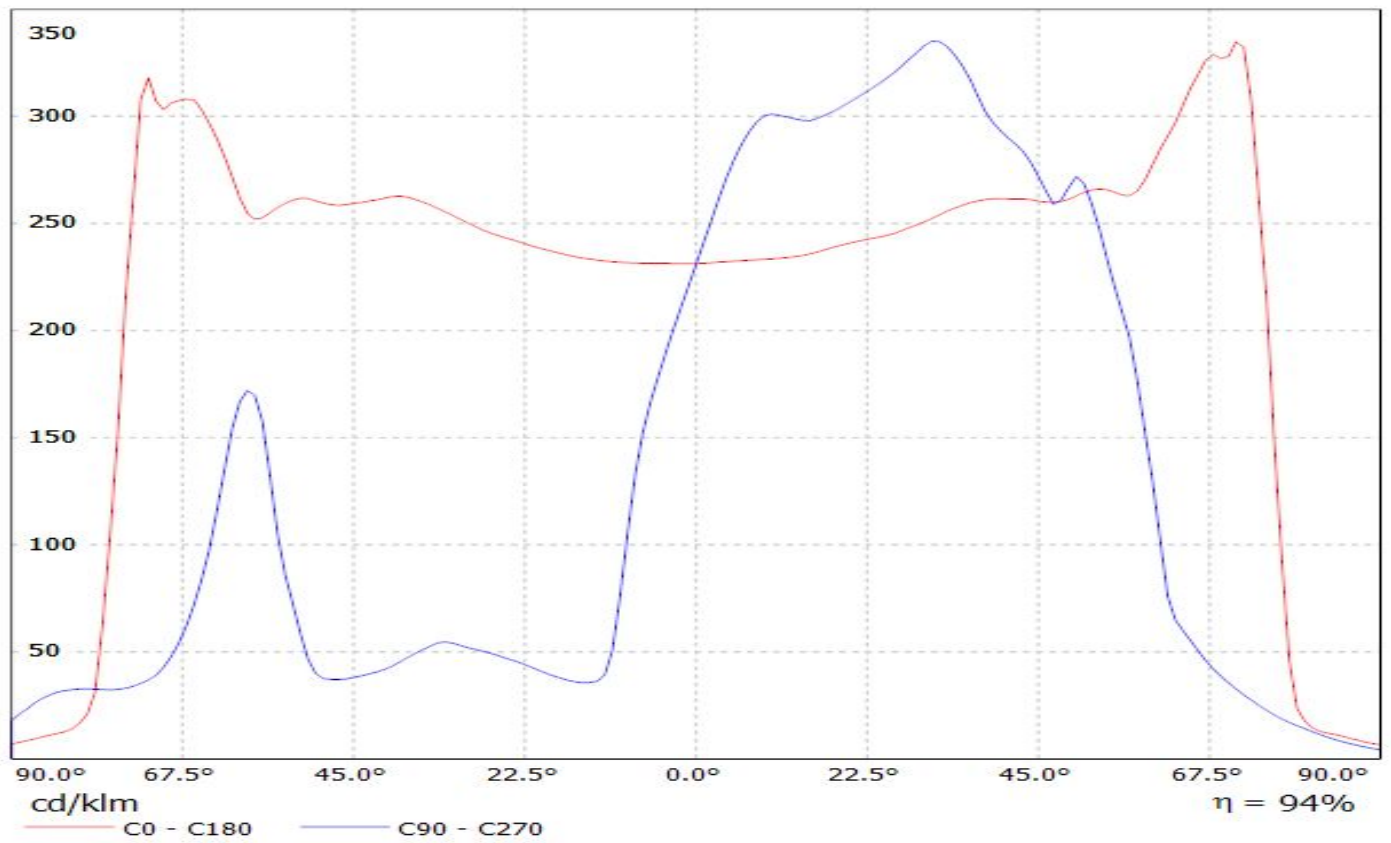

LEDiL Oy C13301_STRADA-2X2-T3_(XP-G2) Eff.92.0% / LDC (Linear)

Luminaire: LEDiL Oy C13301_STRADA-2X2-T3_(XP-G2) Eff.92.0%
Lamps: 1 x CREE XP-G2 (433lm@250mA)

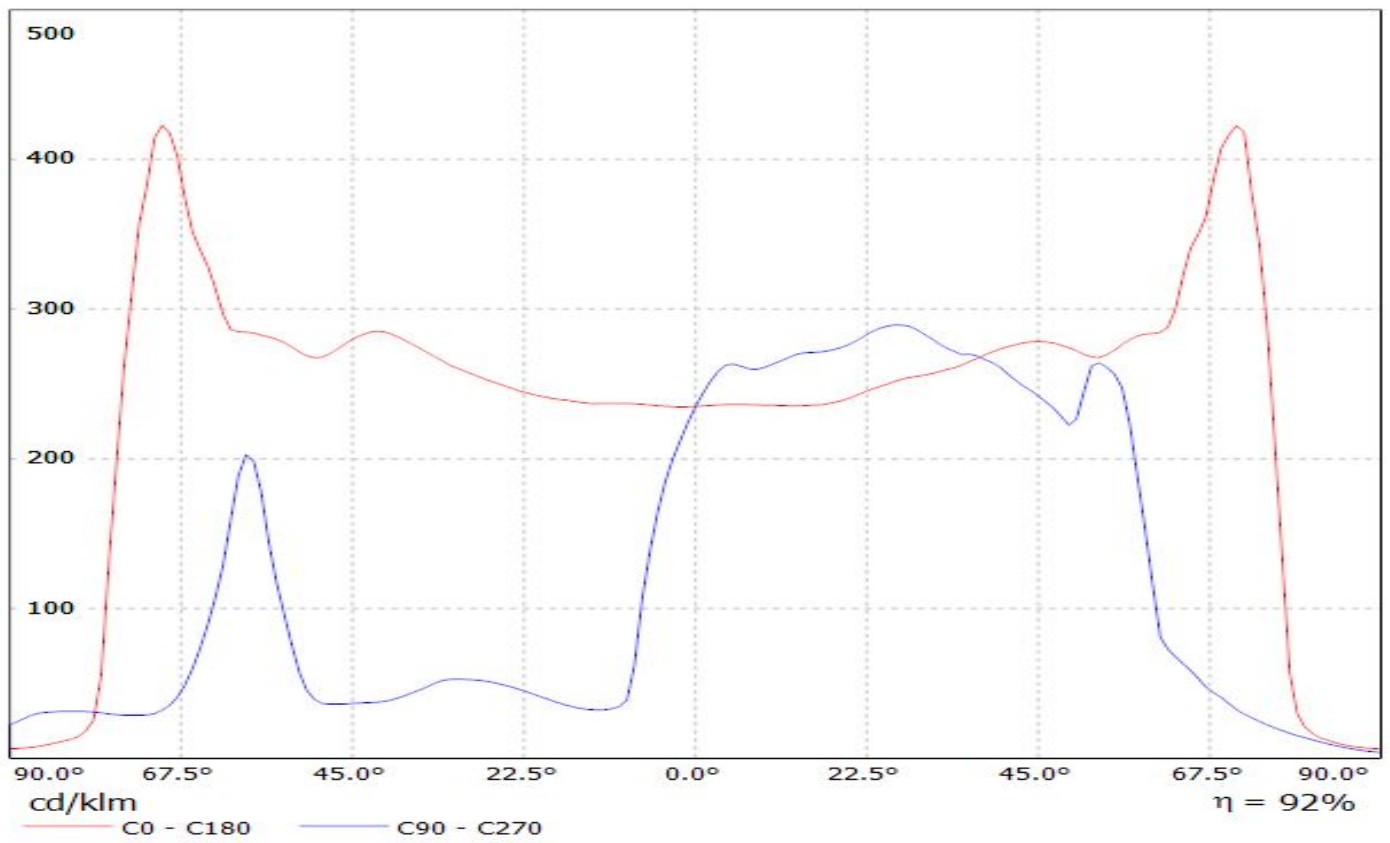

Luminaire: LEDiL Oy C13301_STRADA-2X2-T3_(Luxeon_TX)
Lamps: 1 x Luxeon_TX_2x2_321.384lm@250mA_P=2.79488W_I=249.9mA

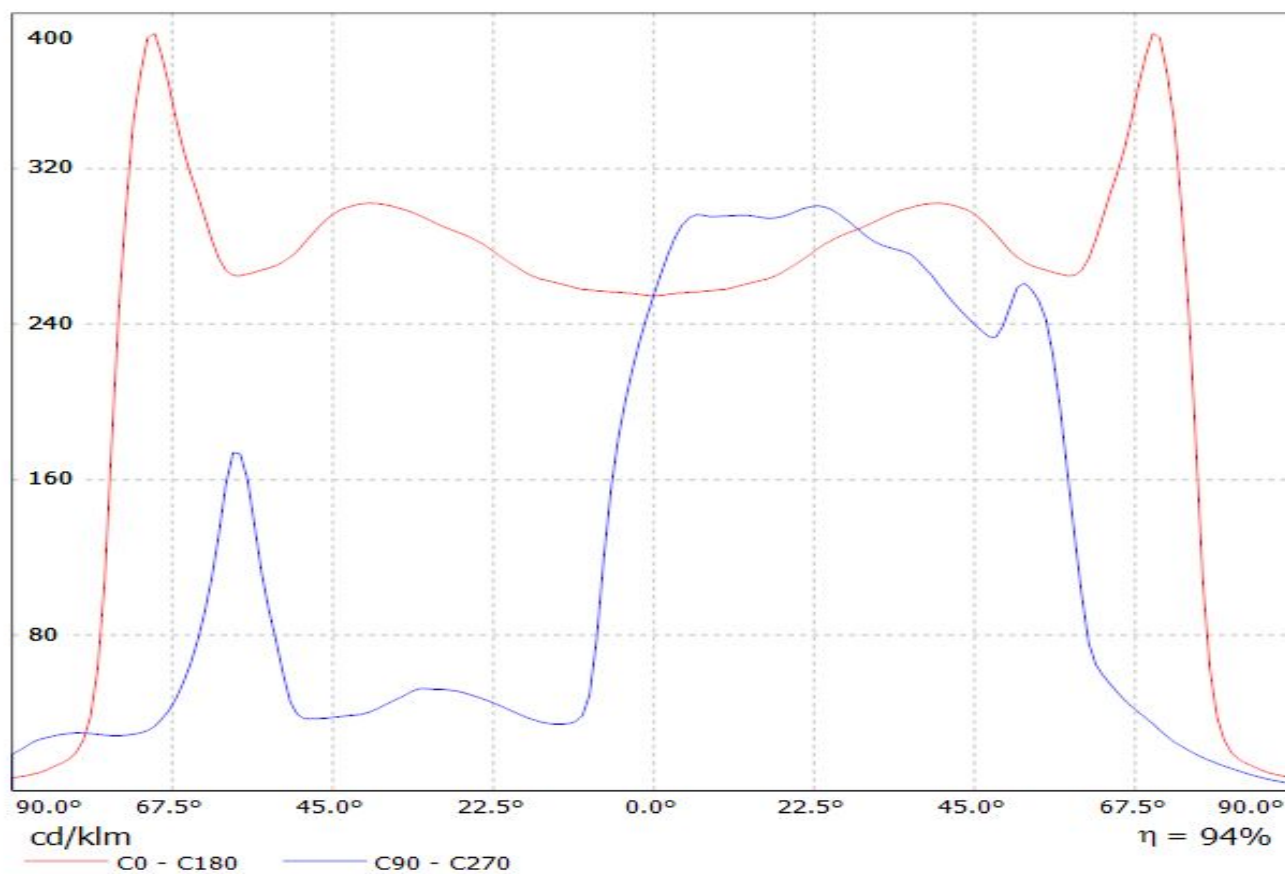

LEDiL Oy C13301_STRADA-2x2-T3_(N383) Eff.95.9% / LDC (Linear)

Luminaire: LEDiL Oy C13301_STRADA-2x2-T3_(N383) Eff.95.9%
Lamps: 1 x NICHIA_NS9x383 (287.074lm@250mA)

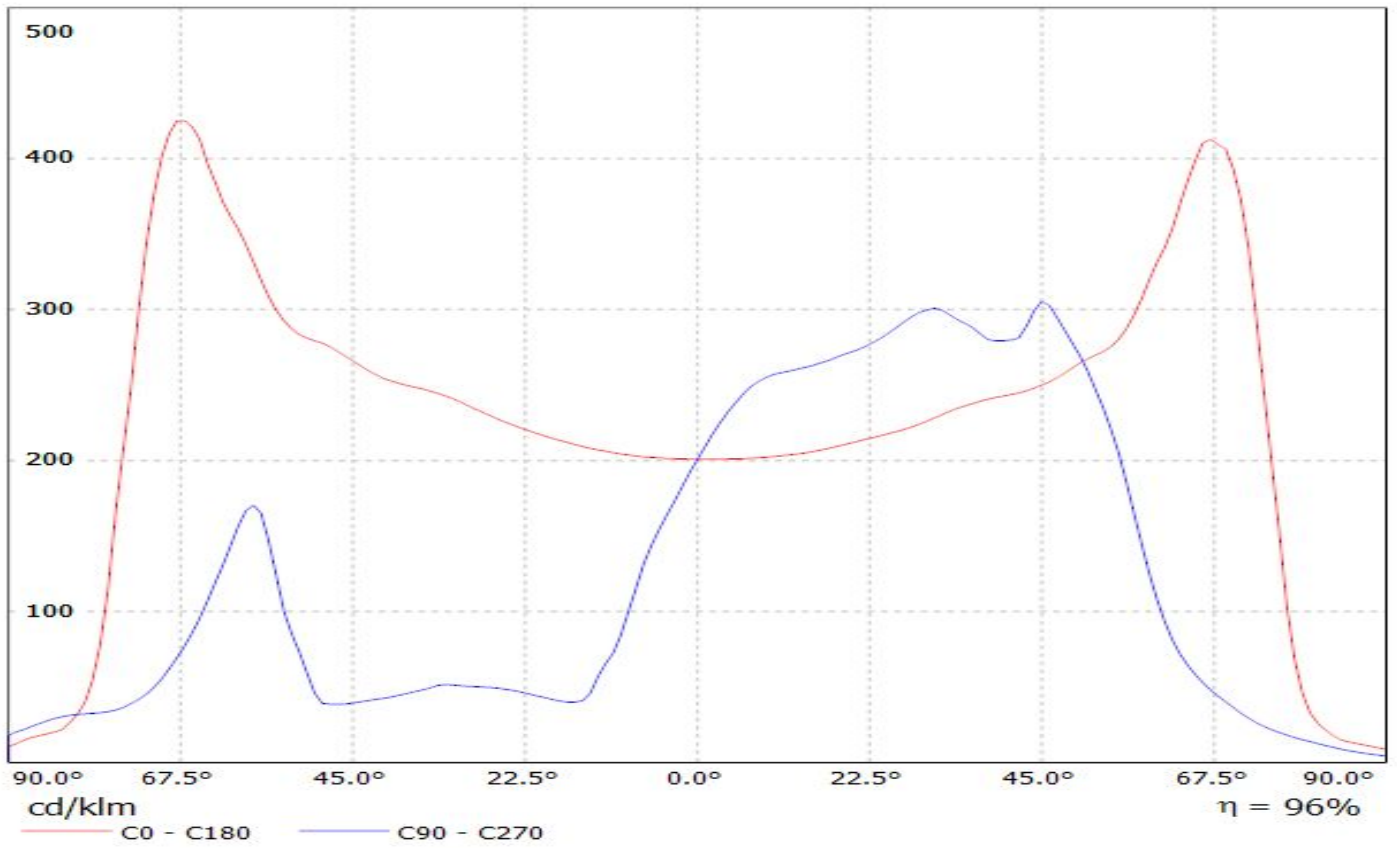

LEDiL Oy C13301_STRADA-2X2-T3_(3535) Eff.94.0% / LDC (Linear)

Luminaire: LEDiL Oy C13301_STRADA-2X2-T3_(3535) Eff.94.0%
Lamps: 1 x Samsung_3535 (343lm@250mA)

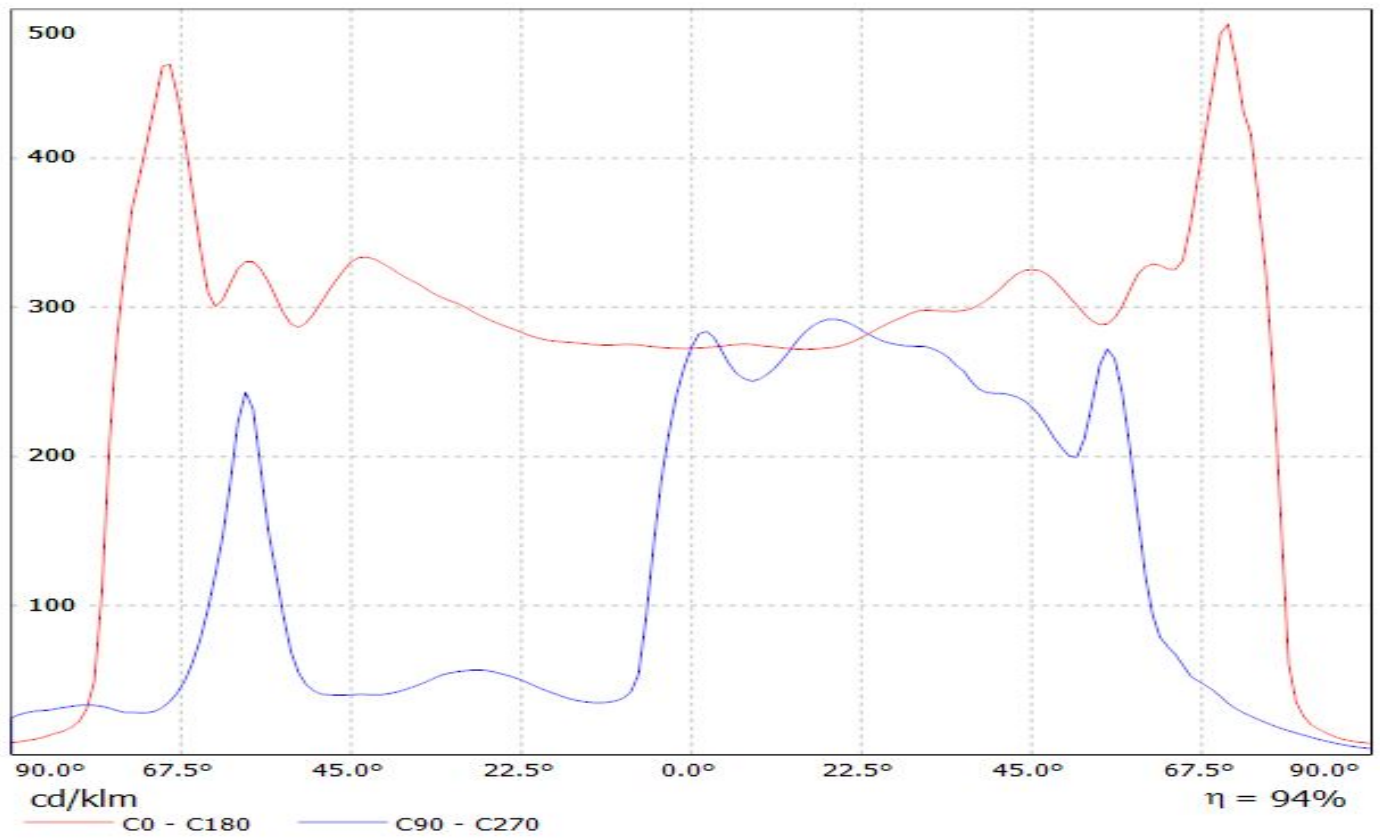

LEDiL Oy C13301_STRADA-2X2-T3_(Nichia_219B) Eff.94.4% / LDC (Linear)

Luminaire: LEDiL Oy C13301_STRADA-2X2-T3_(Nichia_219B) Eff.94.4%
Lamps: 1 x Nichia_219B (310lm@250mA)

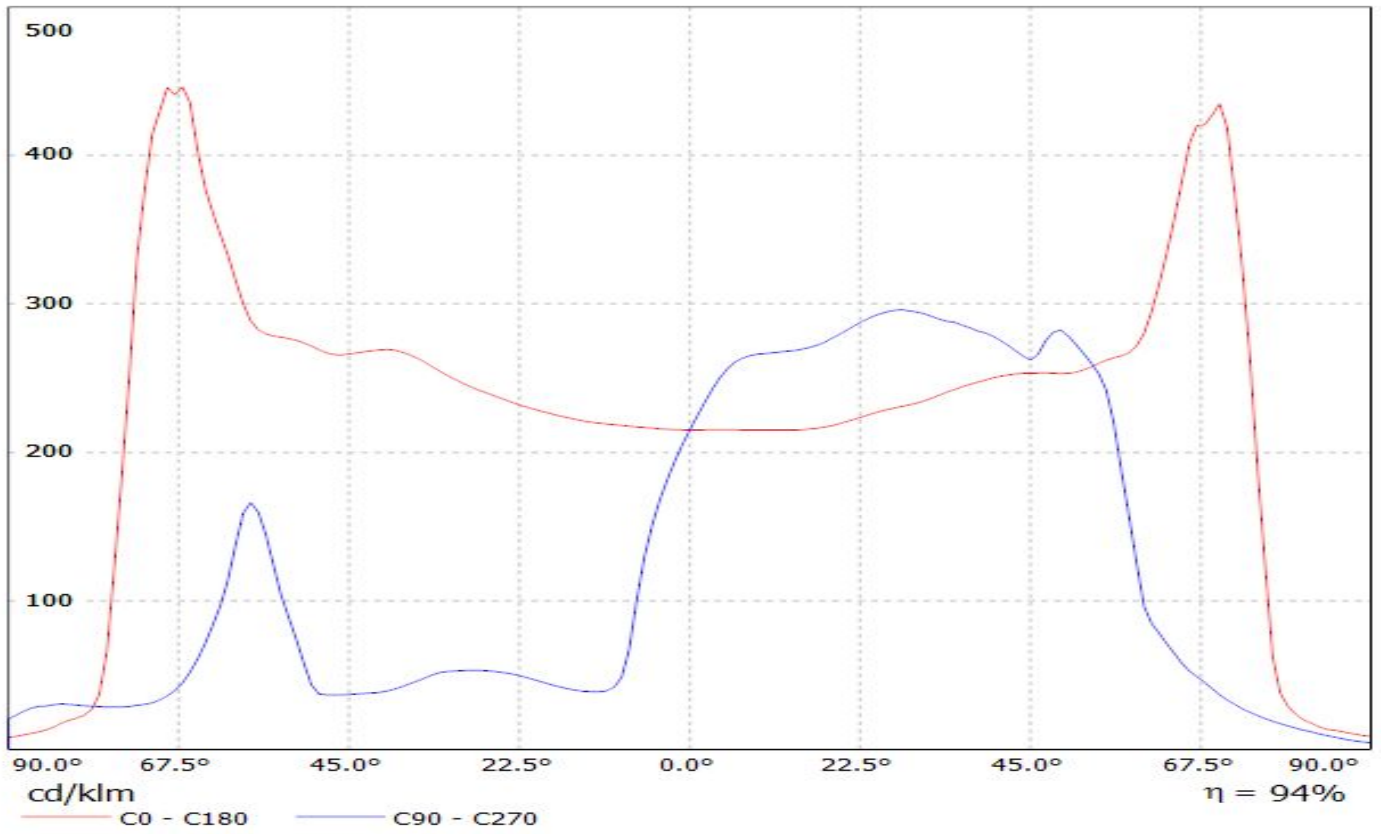

LEDiL Oy C13301_STRADA-2X2-T3_(SSL80) Eff.95.0% / LDC (Linear)

Luminaire: LEDiL Oy C13301_STRADA-2X2-T3_(SSL80) Eff.95.0%

Lamps: 1 x Oslon_SSL80 (311lm@250mA)

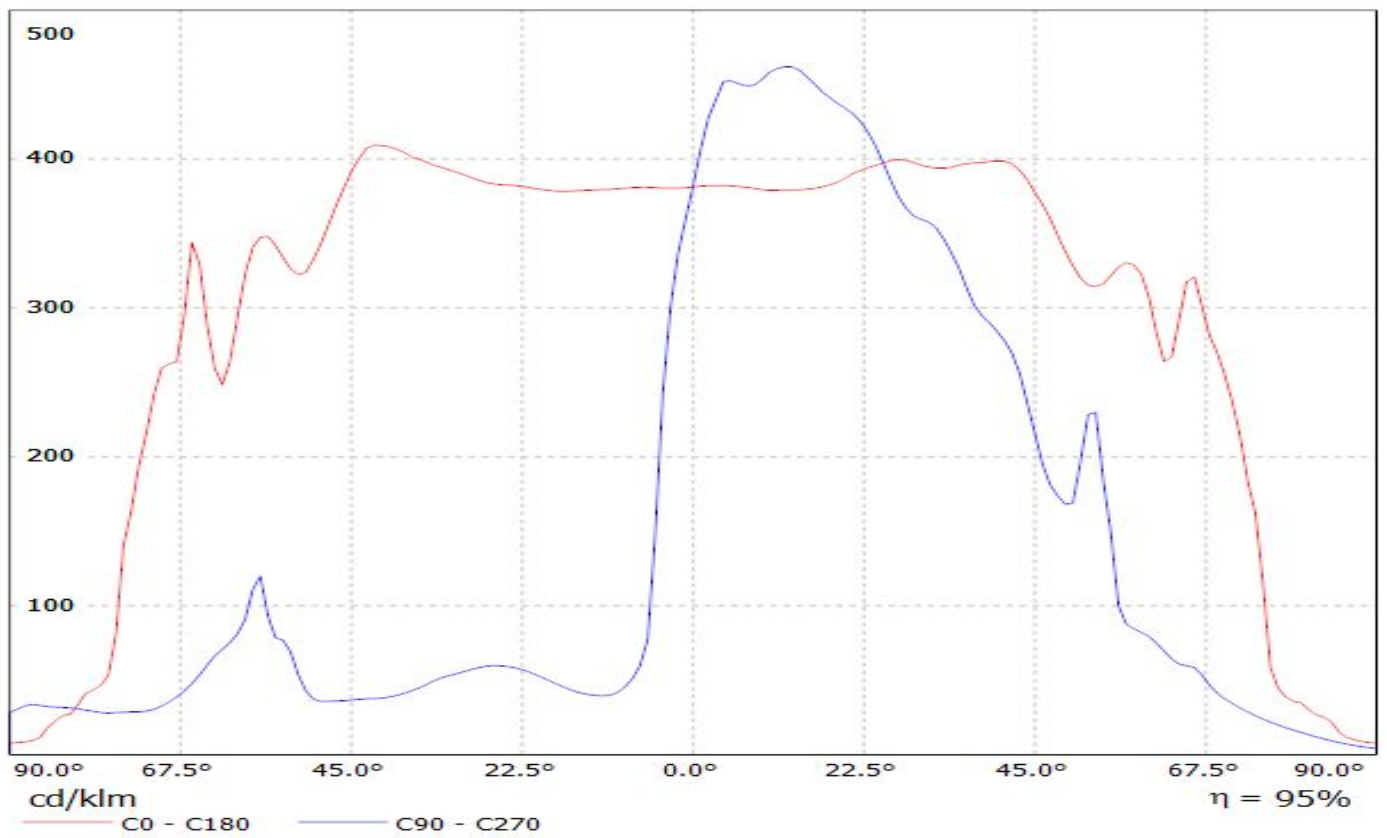

LEDiL Oy C13301_STRADA-2X2-T3_(LG_3535) Eff.94.4% / LDC (Linear)

Luminaire: LEDiL Oy C13301_STRADA-2X2-T3_(LG_3535) Eff.94.4%
Lamps: 1 x LG_3535_Ceramic_2x2 (374lm@250mA)

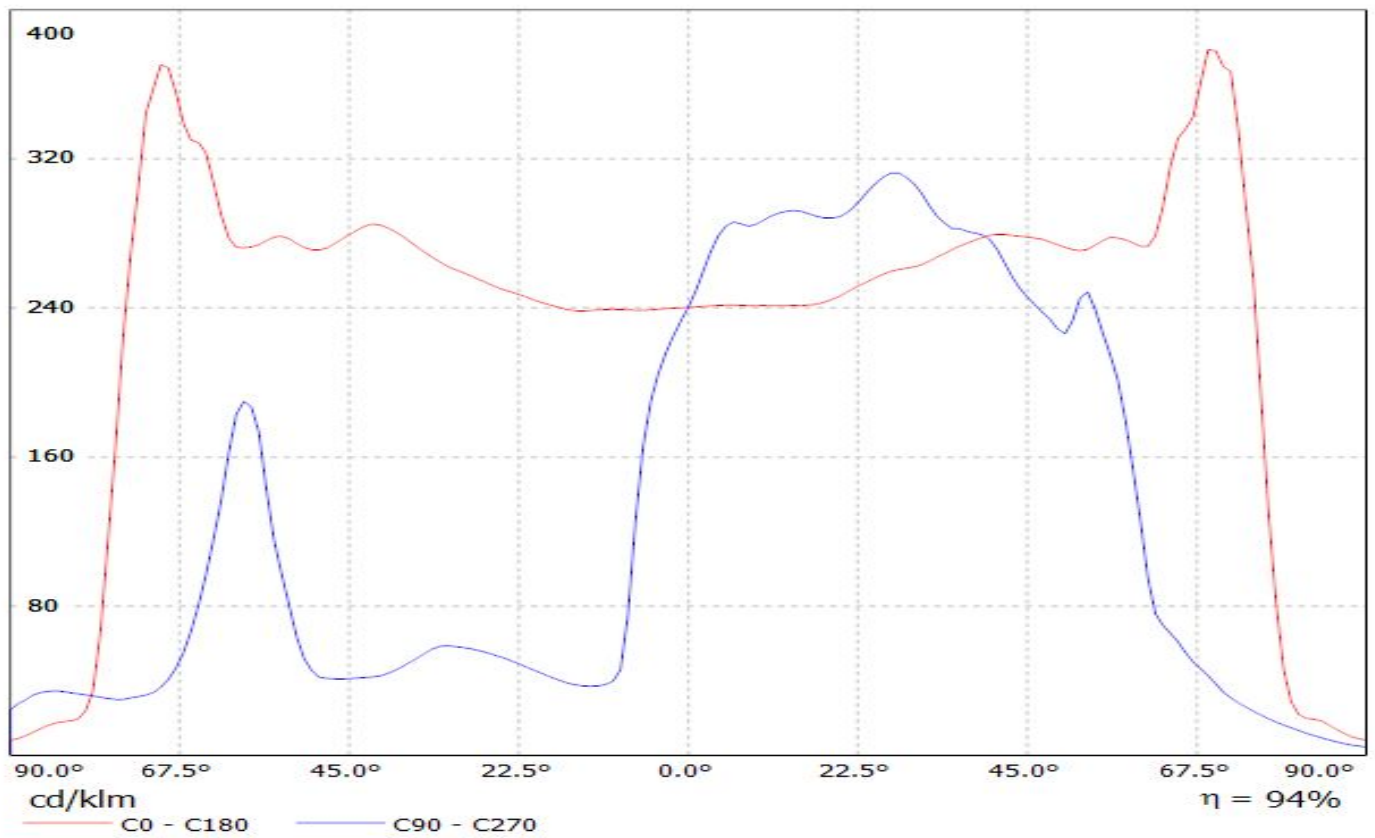

LEDiL Oy C13301_STRADA-2X2-T3_(LG-3535-CERAMIC-GEN2) Eff.94.0% / LDC (Linear)

Luminaire: LEDiL Oy C13301_STRADA-2X2-T3_(LG-3535-CERAMIC-GEN2) Eff.94.0%
Lamps: 1 x LG-3535-CERAMIC-GEN2_2x2_475.25lm@250mA_P=2.8651W_CCT=6562K_I=249.9mA

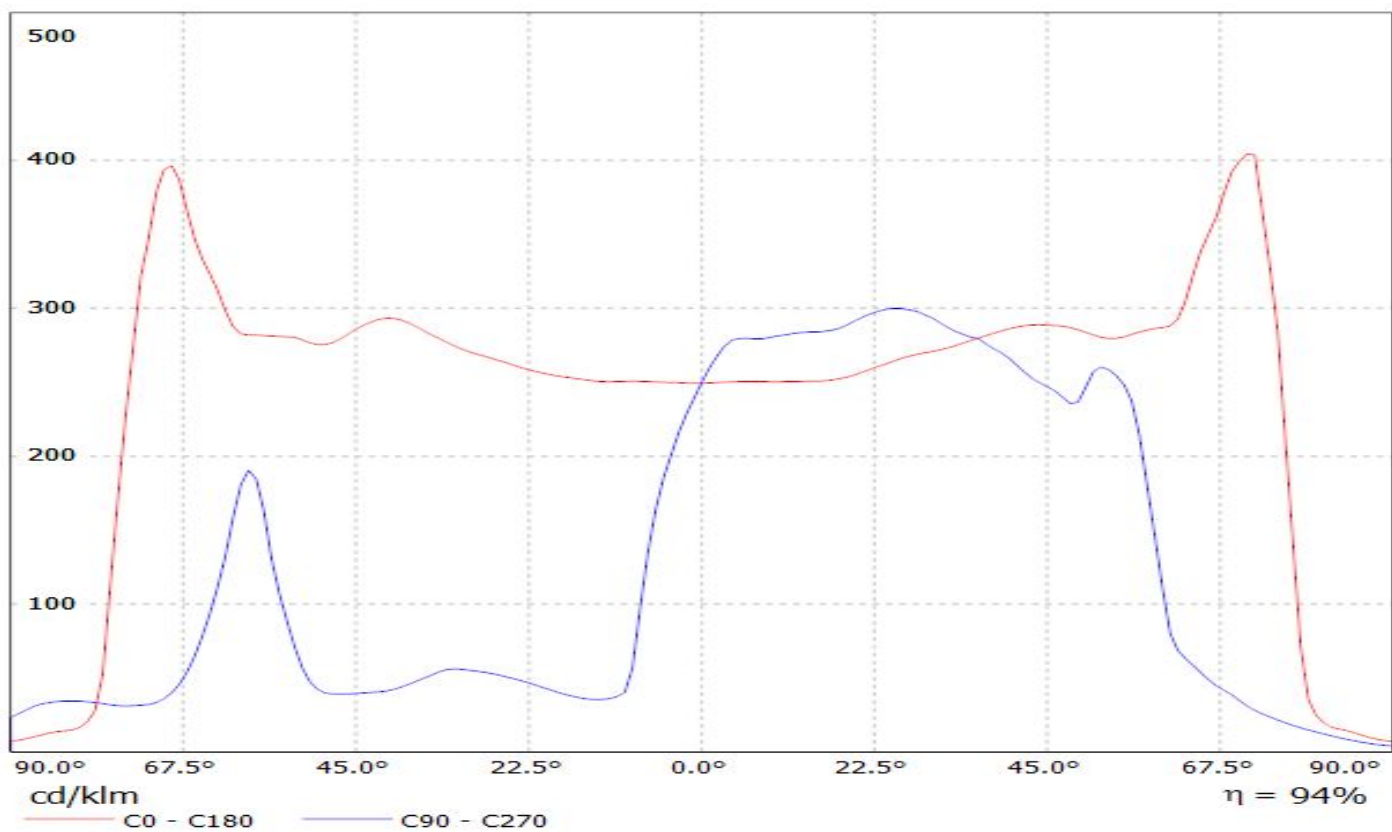

Luminaire: LEDiL Oy C13301_STRADA-2X2-T3_(Luxeon-Z-ES) Eff: 94%
Lamps: 1 x Luxeon Z ES 2x2 (LX22-3090) 209.277lm@250mA_P=2.81W_I=0.2499A

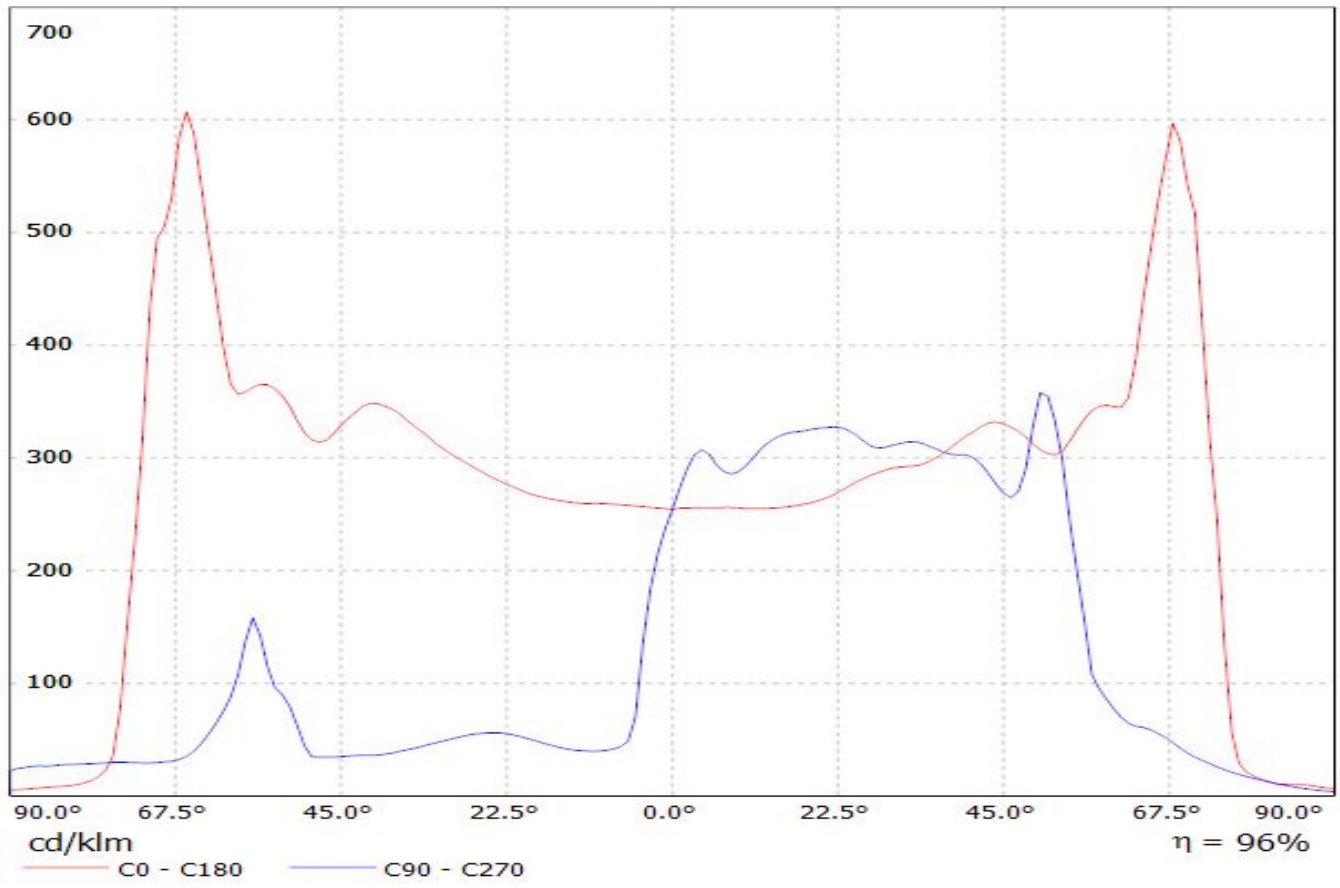

LEDiL Oy C13301_STRADA-2X2-T3_(Z5M) Eff.94.0% / LDC (Linear)

Luminaire: LEDiL Oy C13301_STRADA-2X2-T3_(Z5M) Eff.94.0%

Lamps: 1 x SEOUL_Z5M_(SZ5-M0-W0-00)_362.8lm@250mA_P=2.95788W_I=249.8mA

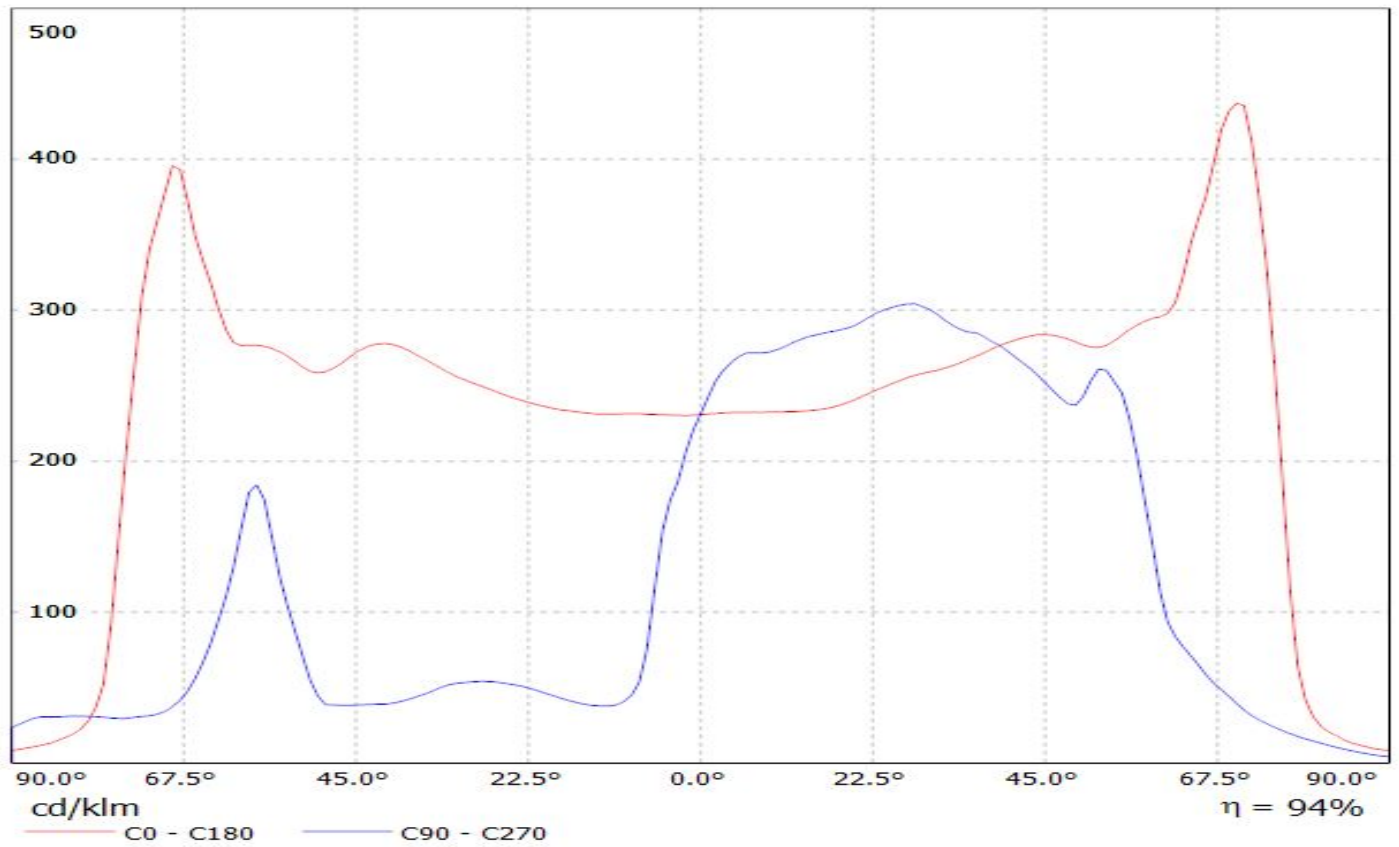

Luminaire: LEDiL Oy C13301_STRADA-2x2-T3_(XP-L)

Lamps: 1 x CREE_XP-L_2x2_(XPLAWT-0-1B0-V40-00-0001)_514lm@250mA_CCT=7600K_P=2.79963W_I=249.9mA

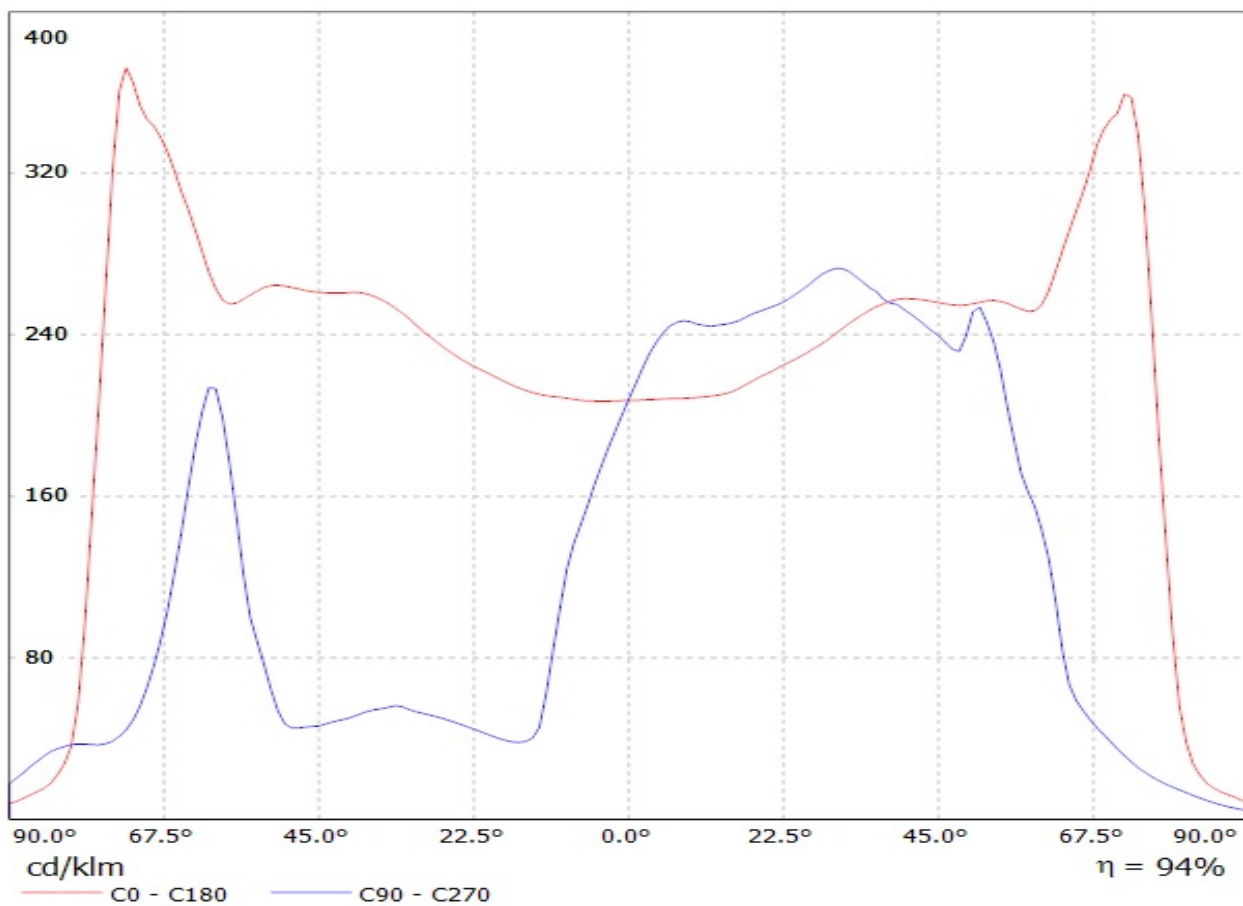

LEDiL Oy C13301_STRADA-2x2-T3_(MJT4040) Eff.94.0% / LDC (Linear)

Luminaire: LEDiL Oy C13301_STRADA-2x2-T3_(MJT4040) Eff.94.0%

Lamps: 1 x SEOUL ACHRICH MJT4040 (SAW09H0A) 258lm@40mA P=2.37W I=40mA

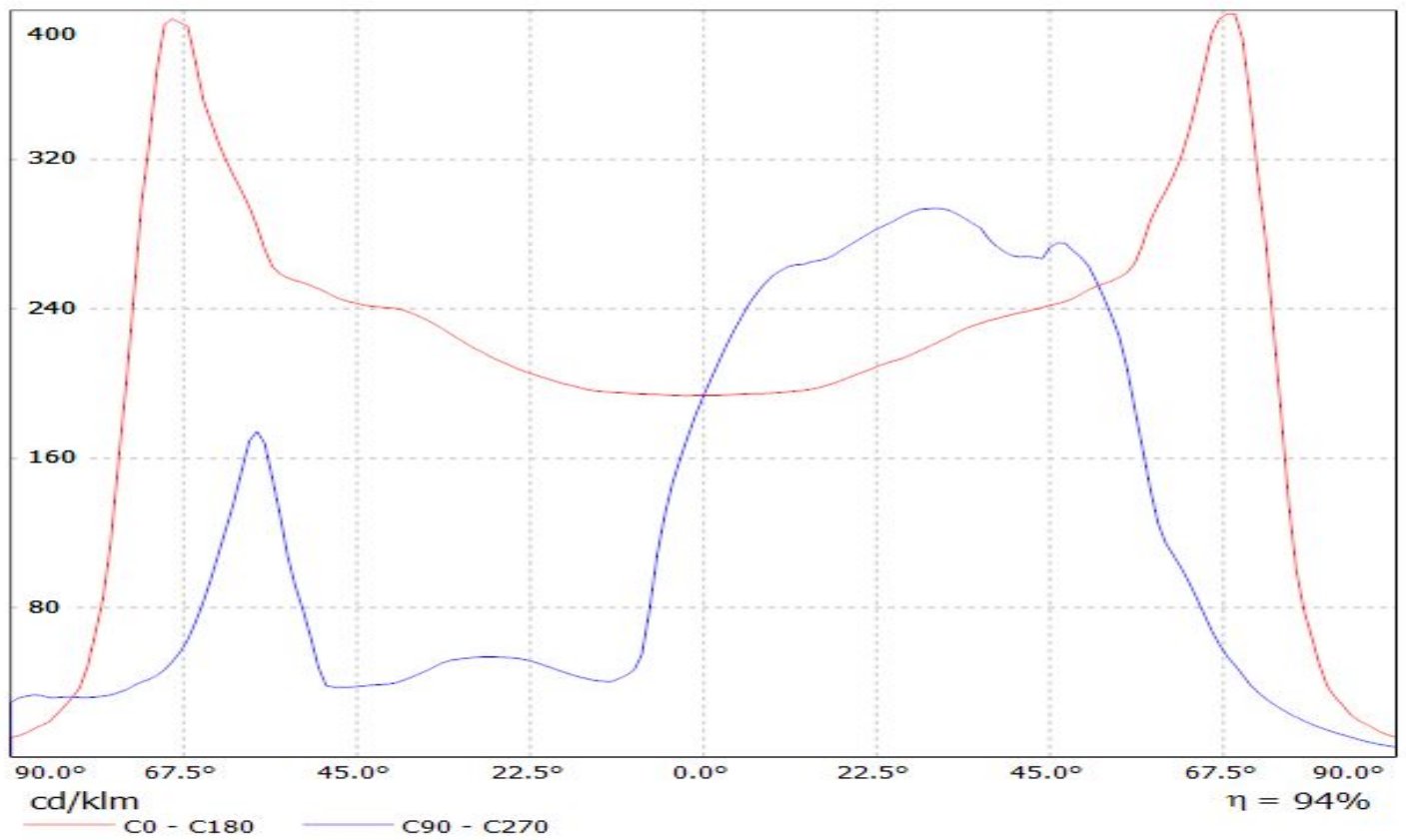

LEDiL Oy C13301_STRADA-2X2-T3_(XP-E2) Eff.94.0% / LDC (Linear)

Luminaire: LEDiL Oy C13301_STRADA-2X2-T3_(XP-E2) Eff.94.0%
Lamps: 1 x CREE_XP-E2_2x2_(XPEBWT-L1-7B4-Q4-0-01)
_340.57lm@250mA_P=2.92366W_I=249.8mA

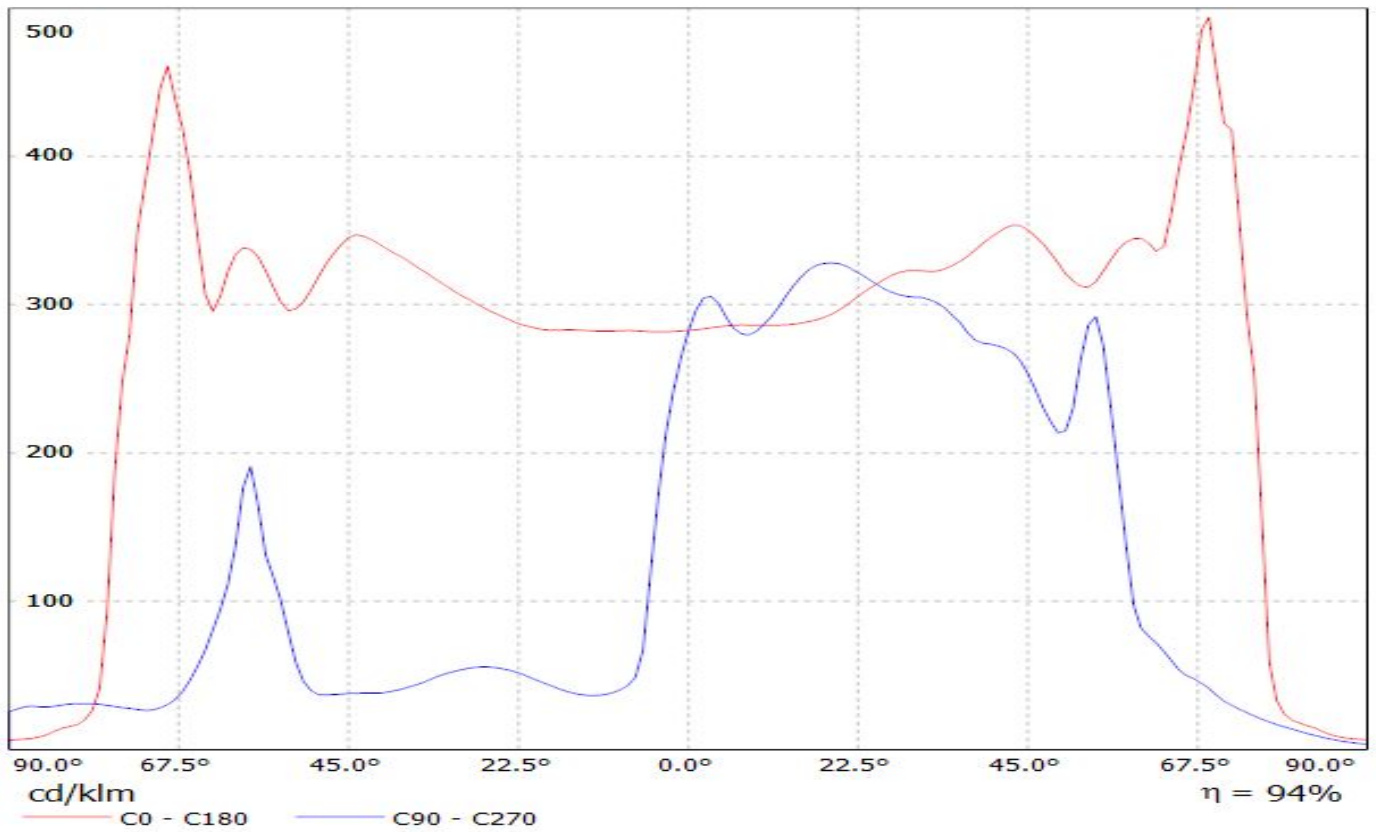

Luminaire: LEDiL Oy C13301_STRADA-2X2-T3_(LH351B)

Lamps: 1 x SAMSUNG_LH351B_2x2_442.67lm@250mA_P=2.84311W_I=249.9mA

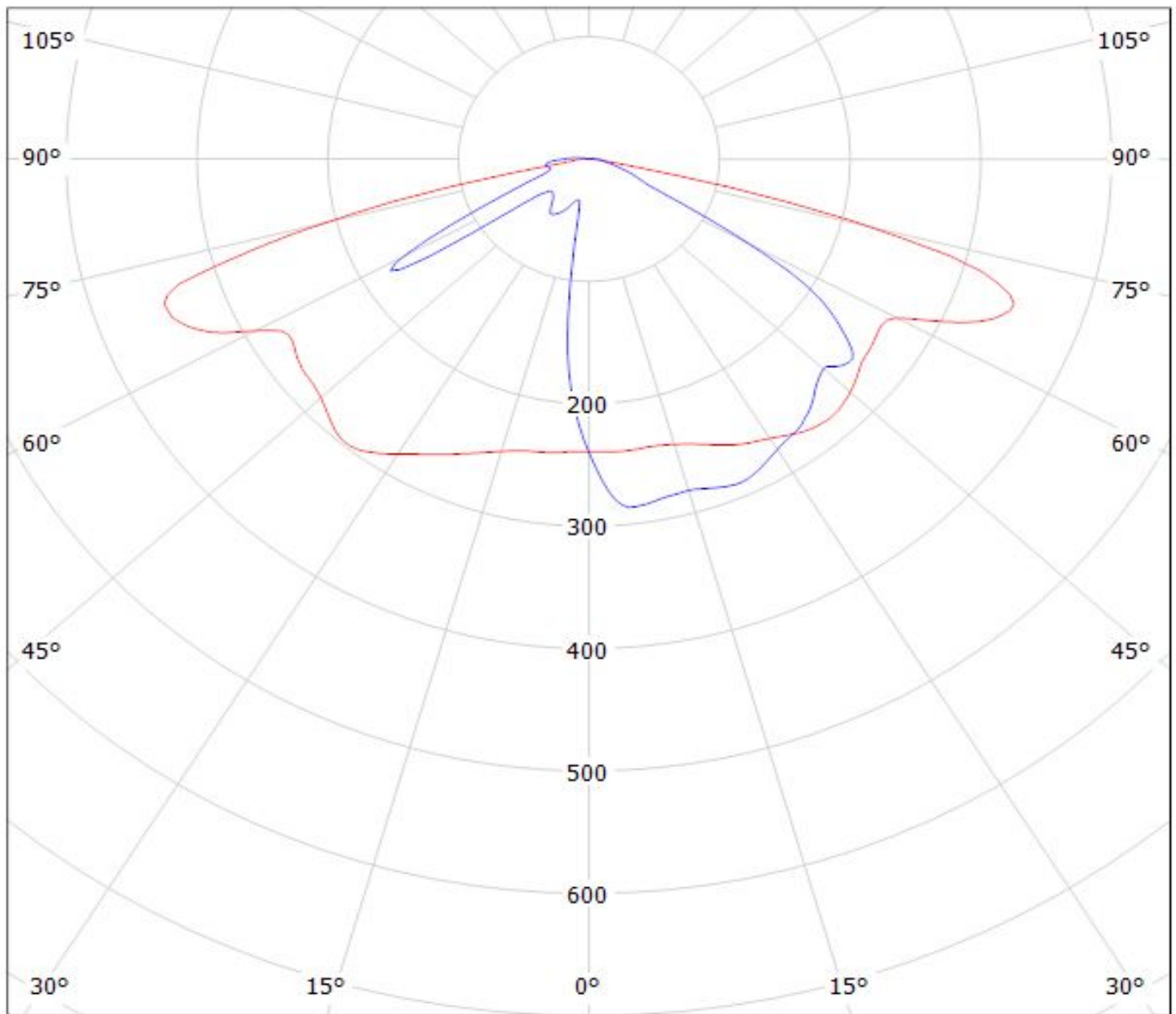

cd/klm

— C0 - C180 — C90 - C270

$\eta = 94\%$

Ledil C13301_STRADA-2X2-T3_(TL1L3) / LDC (Polar)

Luminaire: Ledil C13301_STRADA-2X2-T3_(TL1L3)

Lamps: 1 x Toshiba_TL1L3_2x2_(TL1L3-NW1.L)_387.773lm@250mA_CCT=5000K_P=2.829W_I=0.25A

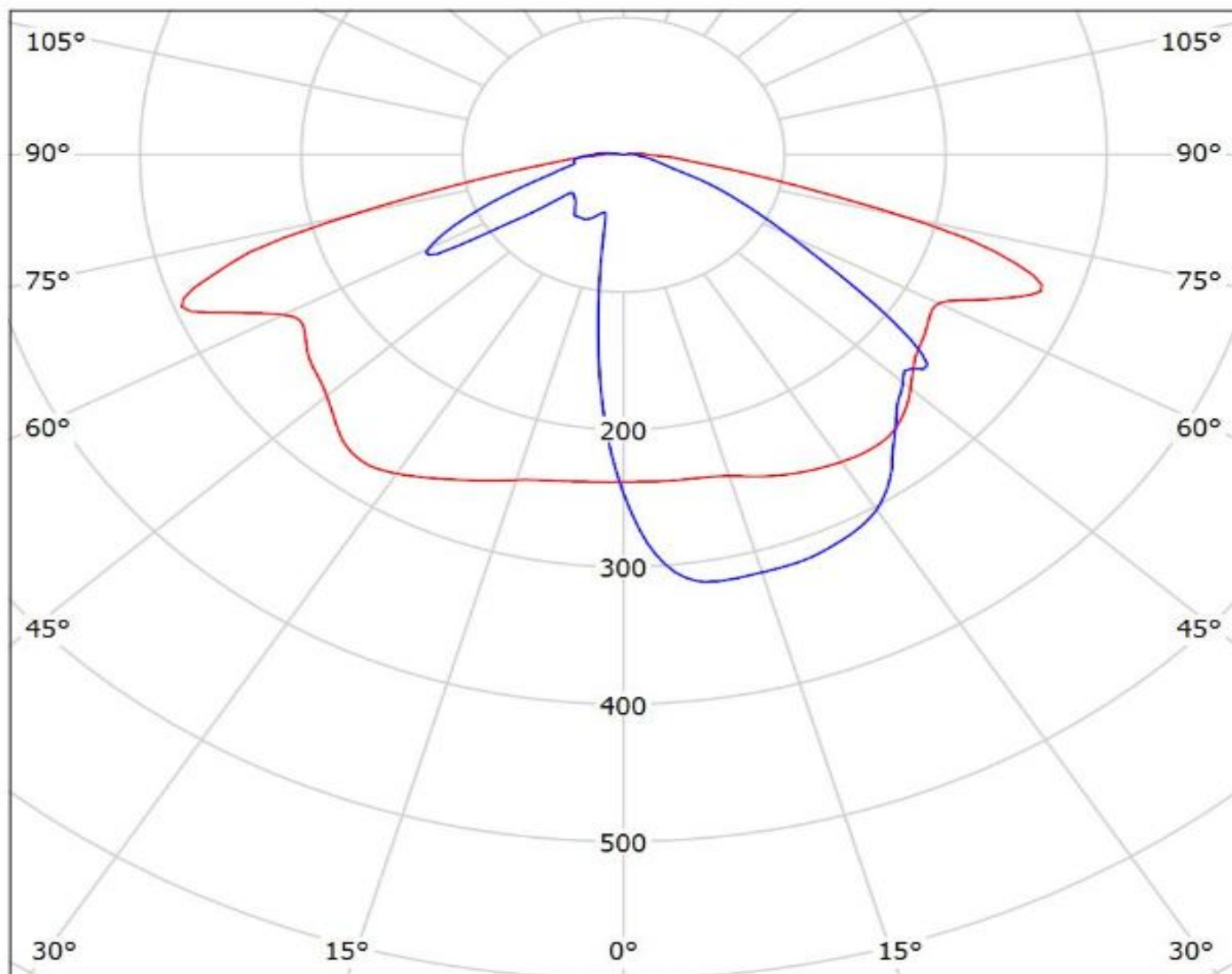

Luminaire: LEDiL Oy C13301_STRADA-2X2-T3_(LUXEON_Q) Eff.96.0%

Lamps: 1 x LUXEON_Q_2x2_(LHQ-3080)_299.038lm@250mA_P=2.8742W_I=249.8mA

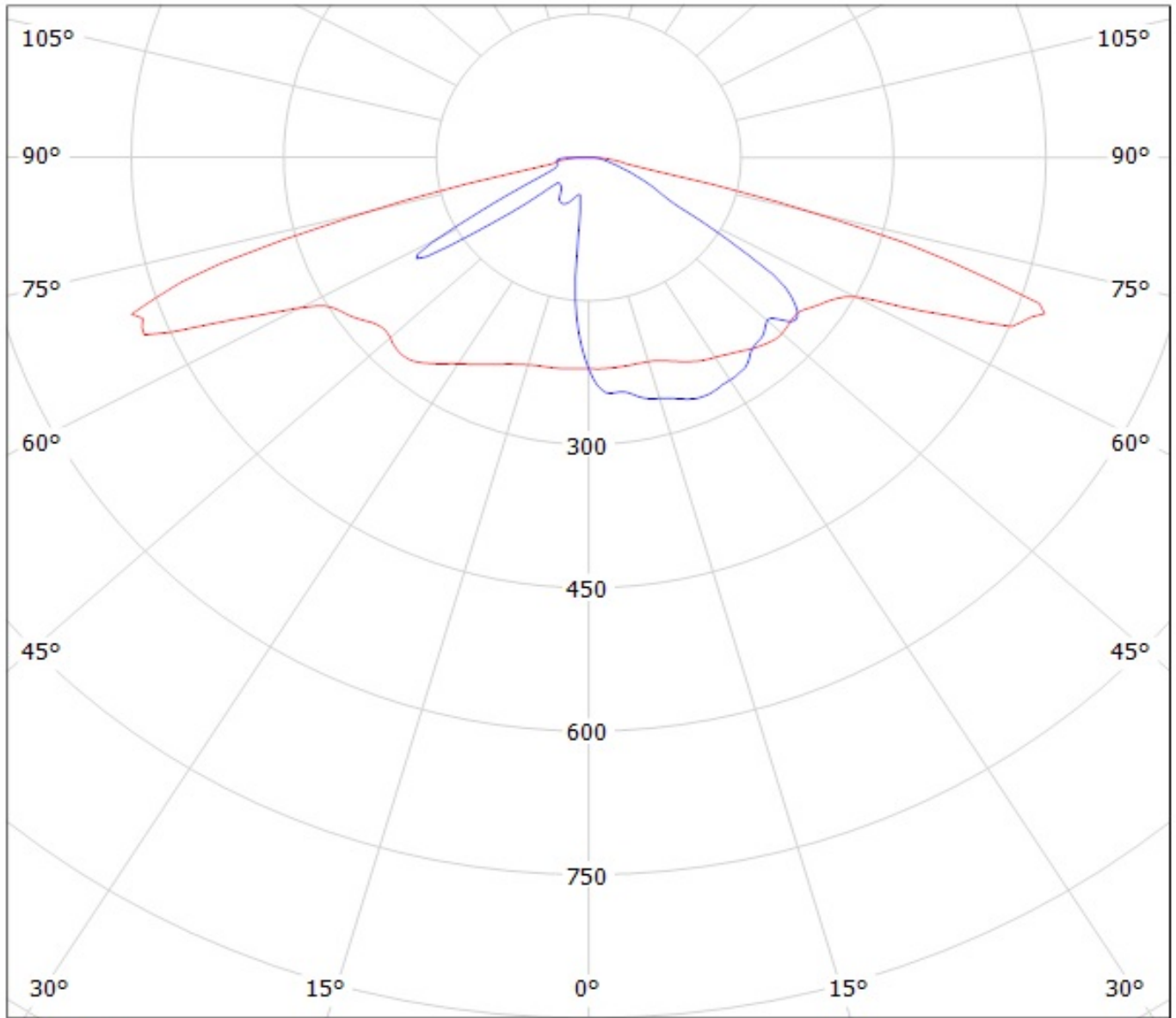

cd/klm

— C0 - C180

— C90 - C270

Luminaire: LEDiL Oy C13301_STRADA-2X2-T3_(Fortimo_F-Flex_2x8_740DAG3)
Lamps: 1 x Philips_Fortimo_F-Flex_2x8_740DAG3_1786.86lm@250mA_P=11.6092W_η=0.2498A

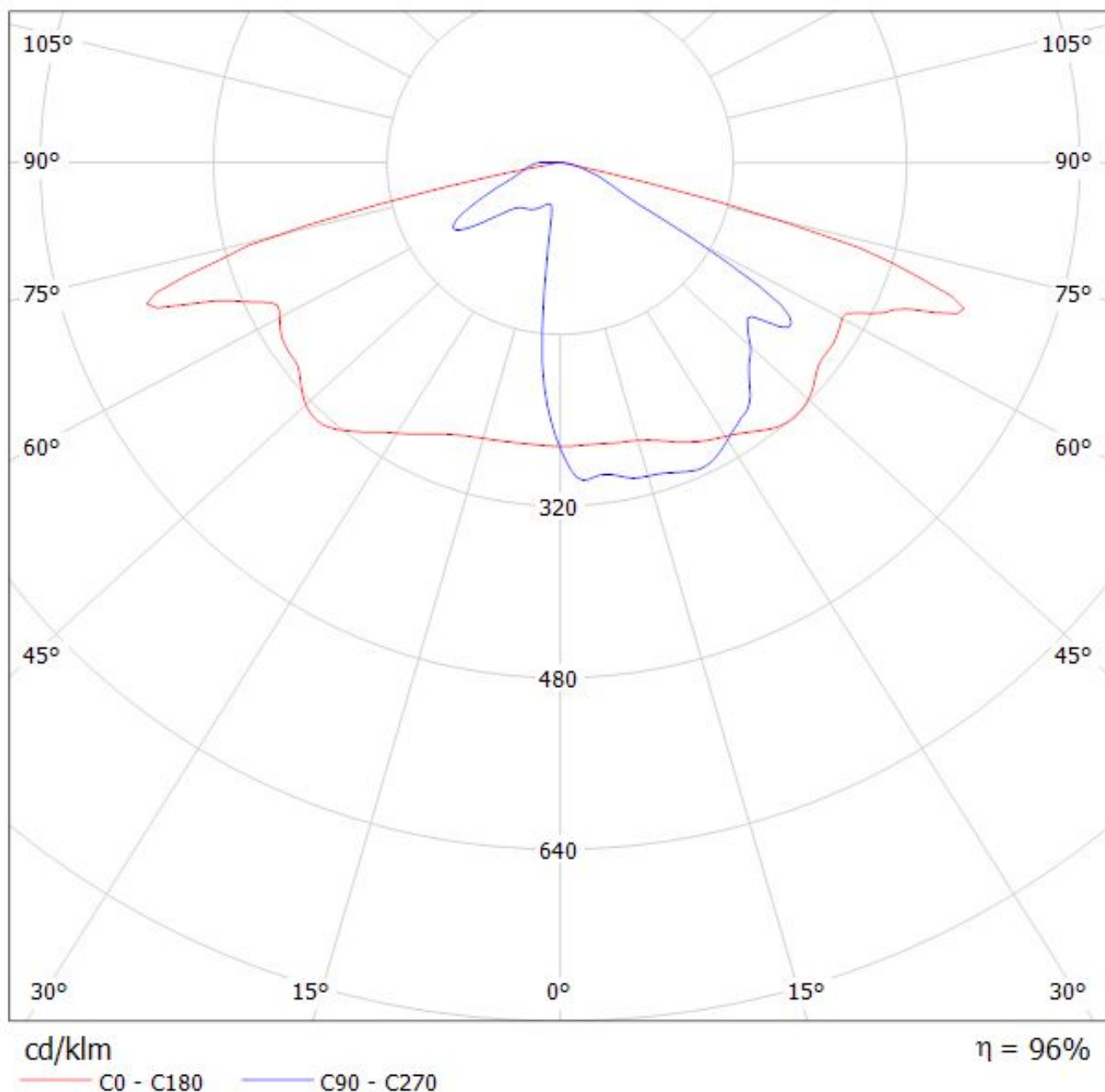

LEDiL Oy C13301_STRADA-2x2-T3_(LUXEON_T) Eff.93.9% / LDC (Polar)

Luminaire: LEDiL Oy C13301_STRADA-2x2-T3_(LUXEON_T) Eff.93.9%

Lamps: 1 x LUXEON_T (294lm@250mA)

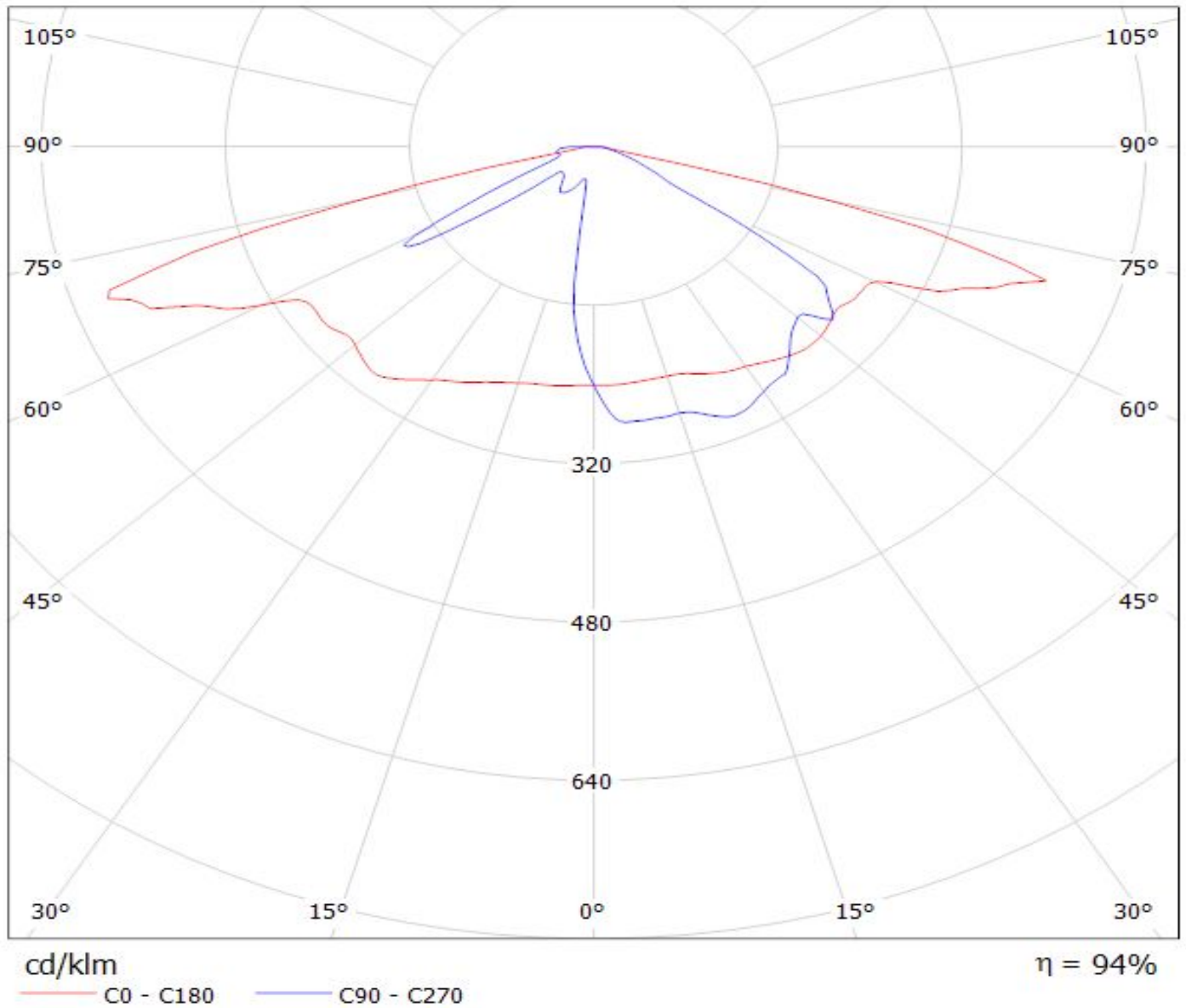

Luminaire: LEDil Oy C13301_STRADA-2X2-T3_(Z5M1) Efficiency=94%

Lamps: 1 x Seoul Z5M1 (SZ5-M1-WN-C8) 379lm @ 250mA CCT=4600K P=2.9W I=250mA

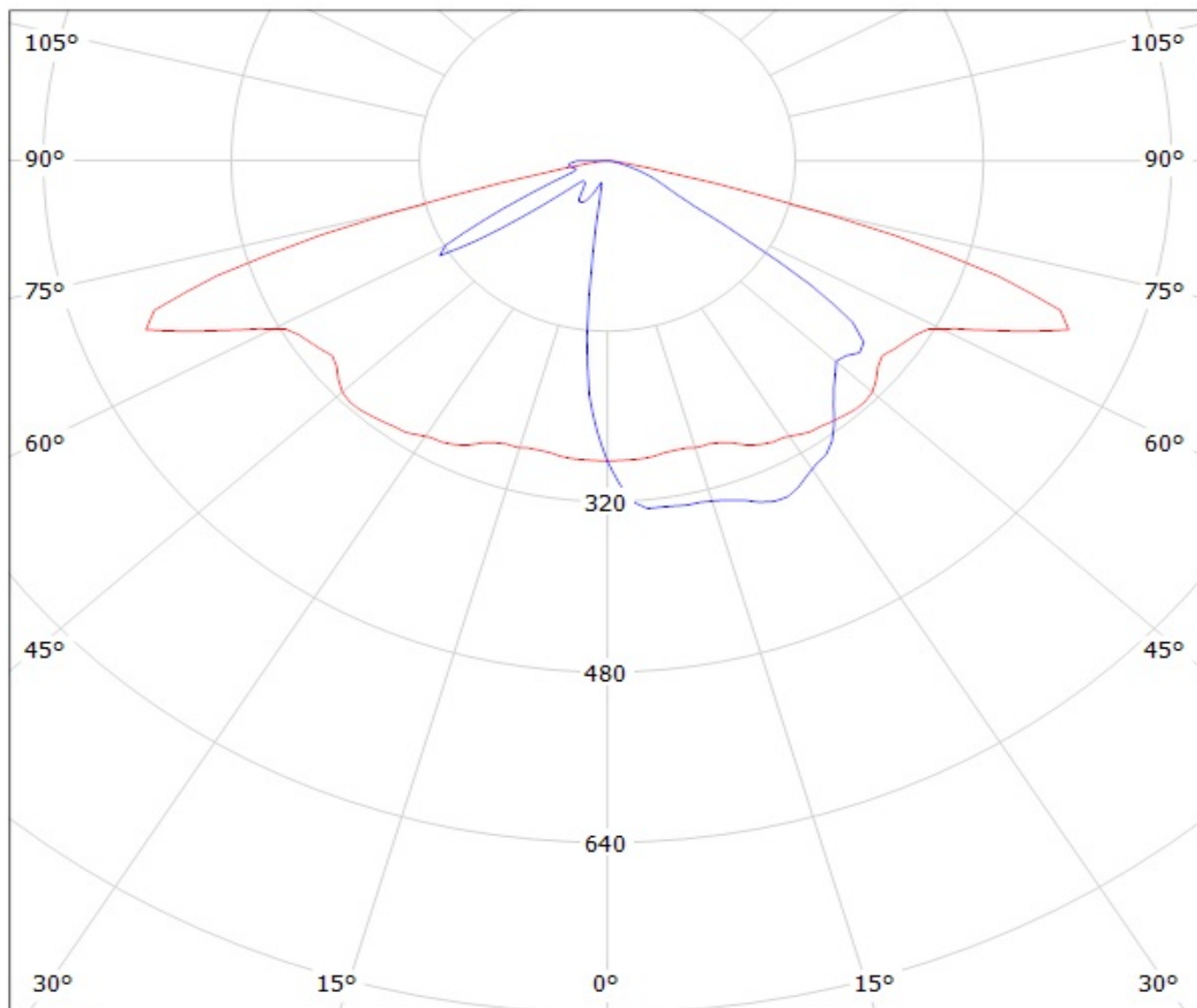

cd/klm

— C0 - C180

— C90 - C270

LEDiL Oy C13301_STRADA-2X2-T3_(XP-G) Eff.94.2% / LDC (Polar)

Luminaire: LEDiL Oy C13301_STRADA-2X2-T3_(XP-G) Eff.94.2%

Lamps: 1 x CREE XP-G2 (259lm@250mA)

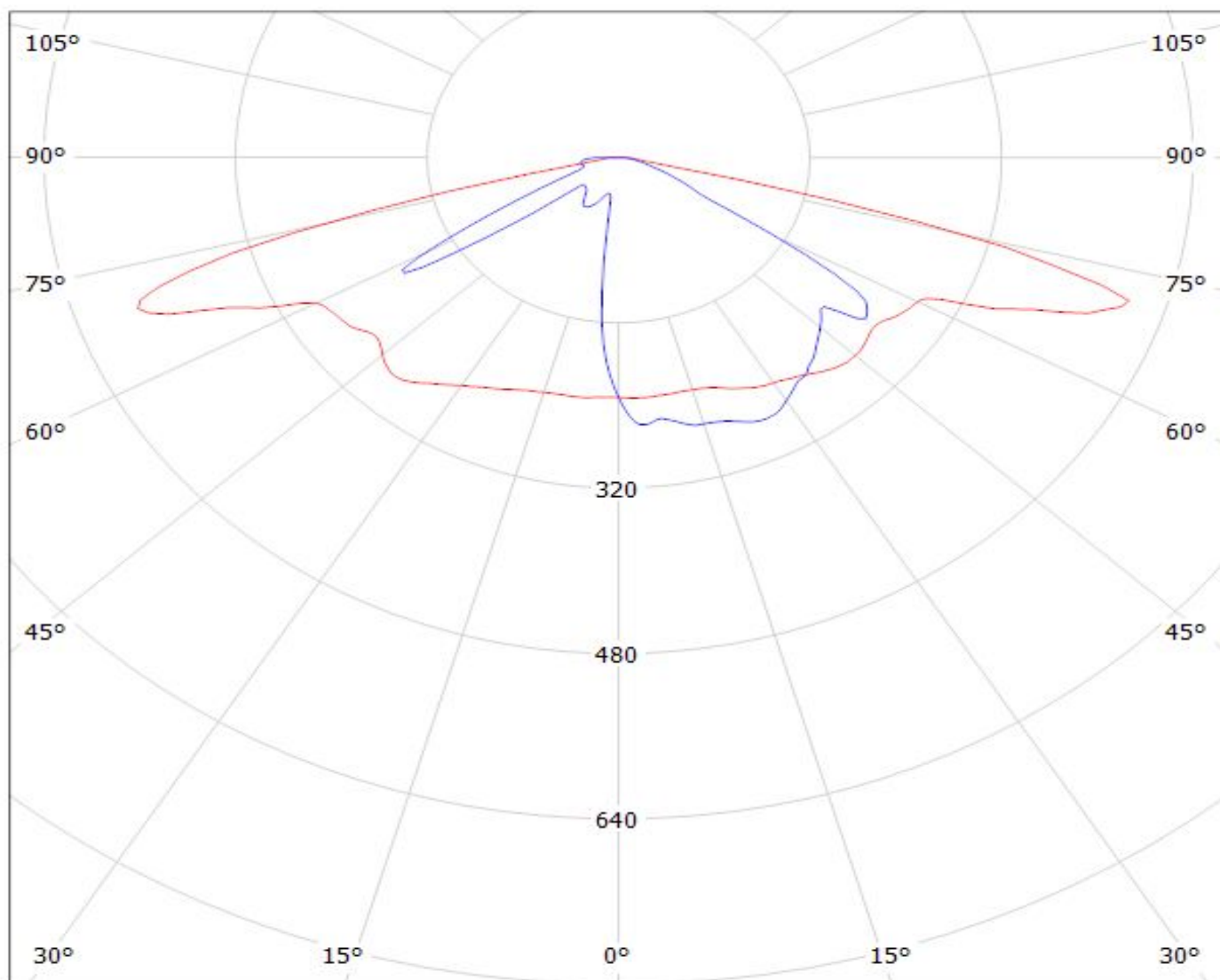

cd/klm

— C0 - C180

— C90 - C270

$\eta = 94\%$

LEDiL Oy C13301_STRADA-2X2-T3_(SQ-PC) Eff.94.3% / LDC (Polar)

Luminaire: LEDiL Oy C13301_STRADA-2X2-T3_(SQ-PC) Eff.94.3%

Lamps: 1 x Oslon Square PC (399lm@250mA)

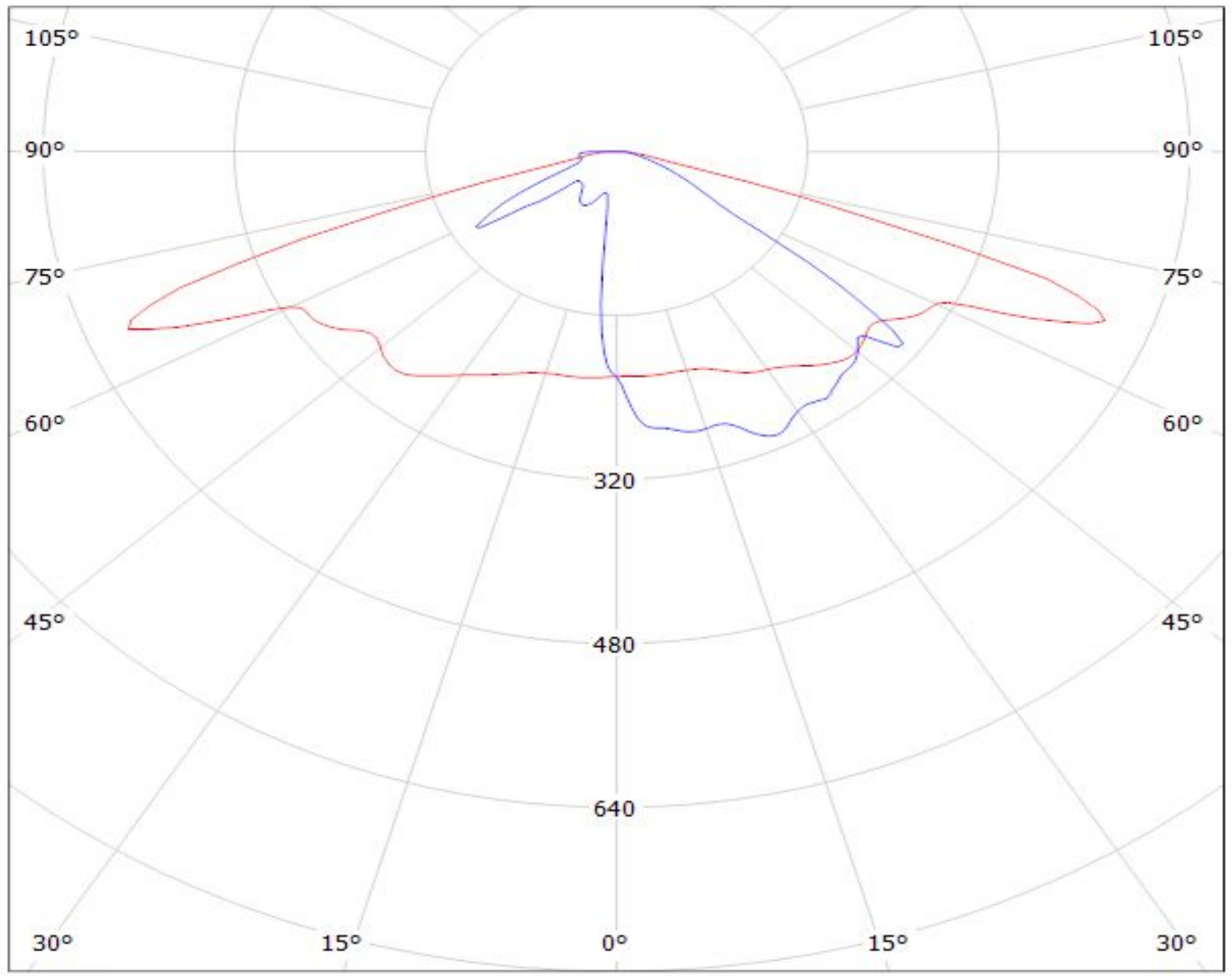

cd/klm

— C0 - C180

— C90 - C270

$\eta = 94\%$

LEDiL Oy C13301_STRADA-2X2-T3_(XT-E) 95.0% / LDC (Polar)

Luminaire: LEDiL Oy C13301_STRADA-2X2-T3_(XT-E) 95.0%

Lamps: 1 x CREE_XT-E (390lm@250mA)

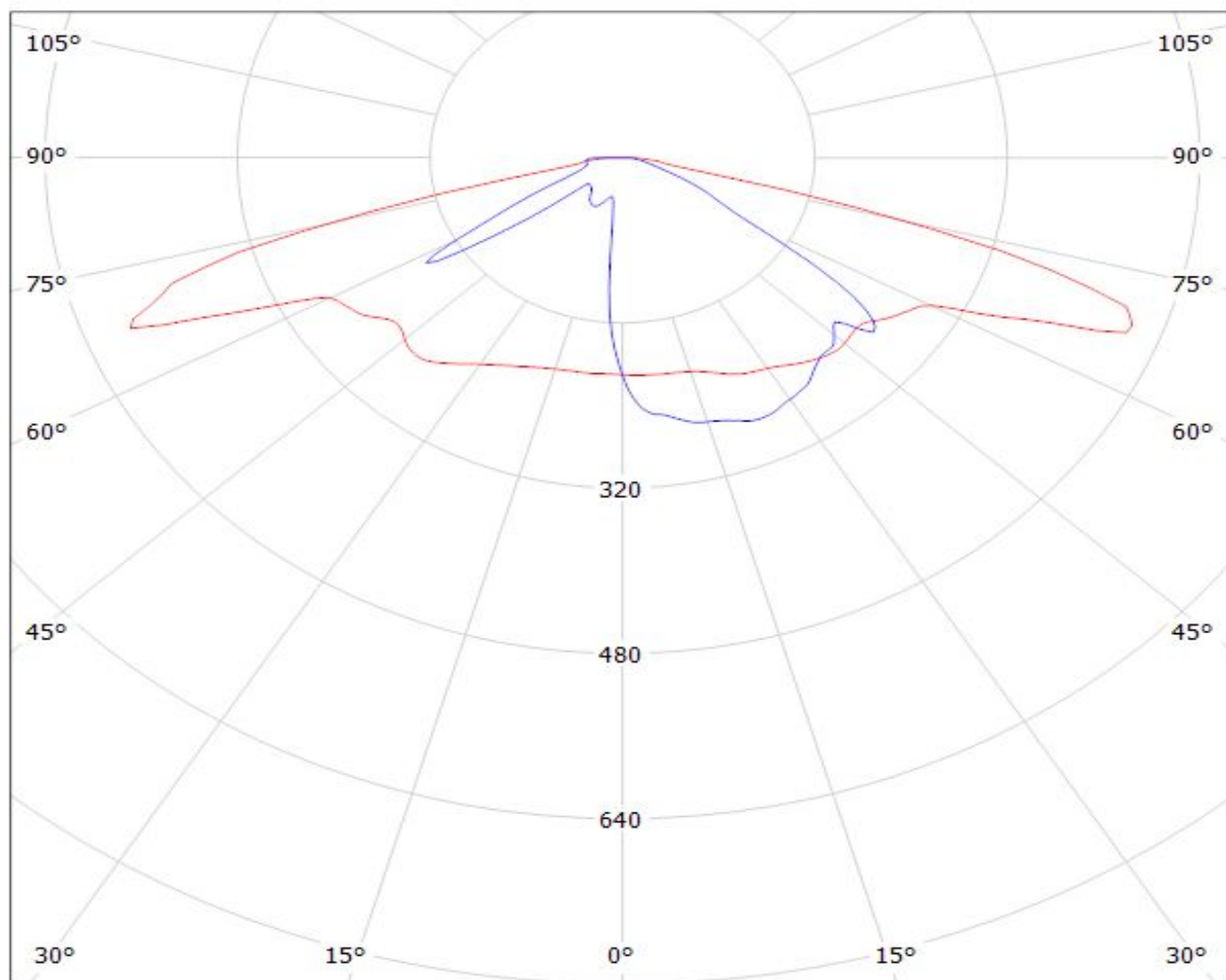

cd/klm

— C0 - C180

— C90 - C270

$\eta = 95\%$

LEDiL Oy C13301_STRADA-2X2-T3_(Rebel-ES) Eff.94.1% / LDC (Polar)

Luminaire: LEDiL Oy C13301_STRADA-2X2-T3_(Rebel-ES) Eff.94.1%

Lamps: 1 x Rebel-ES (341lm@250mA)

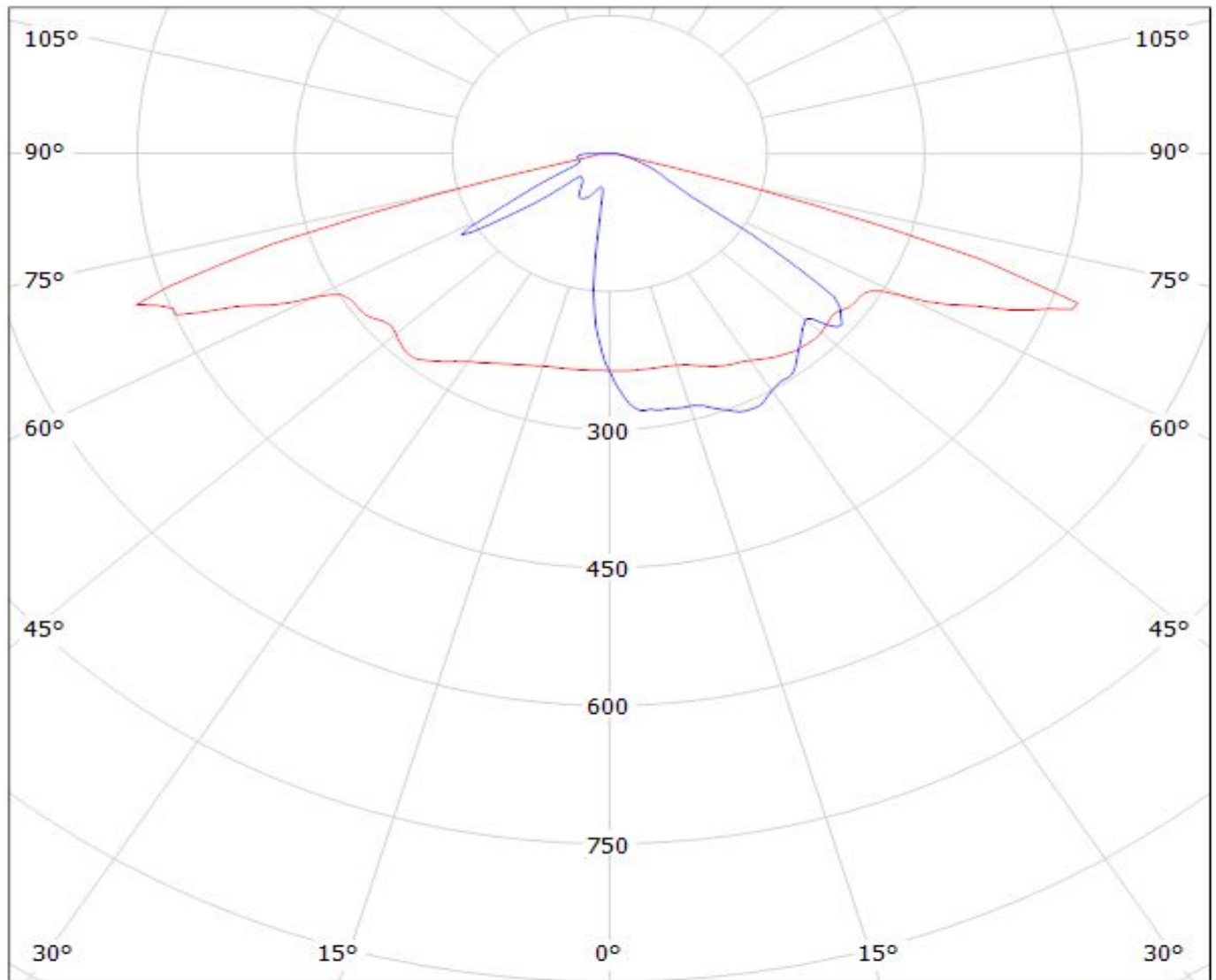

cd/klm

— C0 - C180

— C90 - C270

$\eta = 94\%$

LEDiL Oy C13300_STRADA-2X2-T2_(LUXEON_R) Eff.94.4% / LDC (Polar)

Luminaire: LEDiL Oy C13300_STRADA-2X2-T2_(LUXEON_R) Eff.94.4%

Lamps: 1 x LUXEON_R (315lm@250mA)

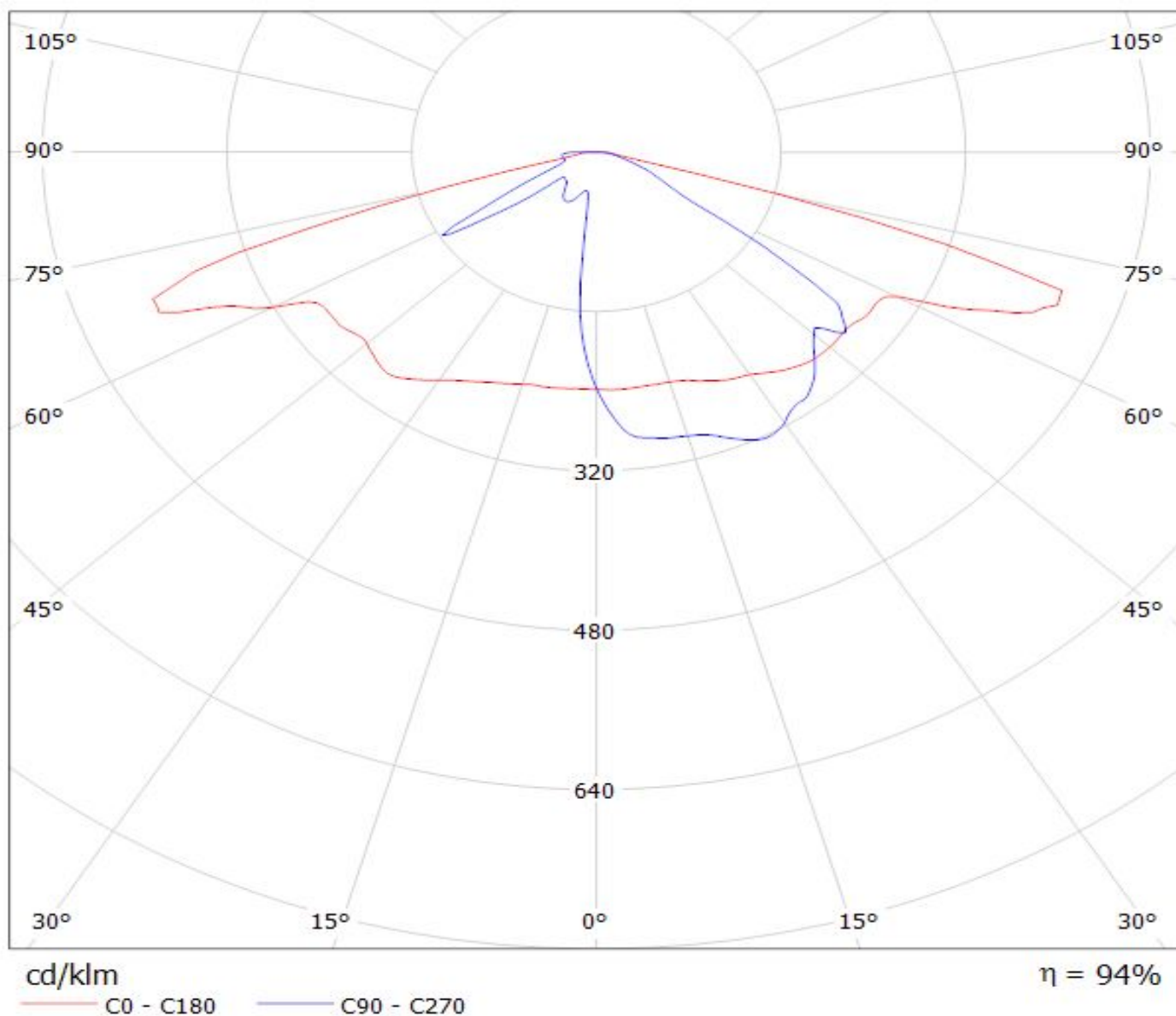

LEDiL Oy C13301_STRADA-2X2-T3_(Z5P) Eff.94.3% / LDC (Polar)

Luminaire: LEDiL Oy C13301_STRADA-2X2-T3_(Z5P) Eff.94.3%

Lamps: 1 x Seoul Z5P (290lm@250mA)

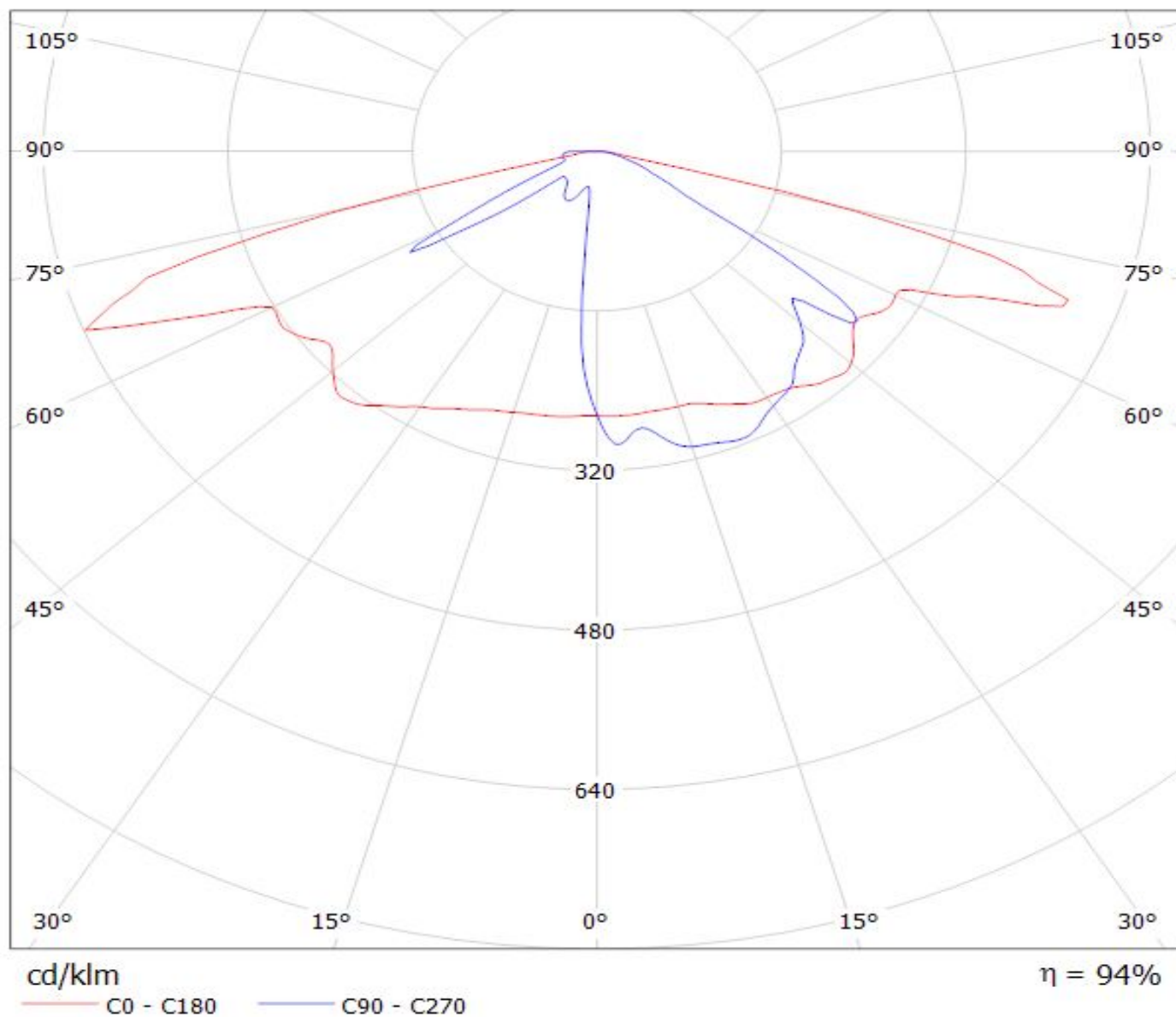

LEDiL Oy C13301_STRADA-2X2-T3_(XM-L2) Eff.94.3% / LDC (Polar)

Luminaire: LEDiL Oy C13301_STRADA-2X2-T3_(XM-L2) Eff.94.3%

Lamps: 1 x XM-L2 (366lm@250mA)

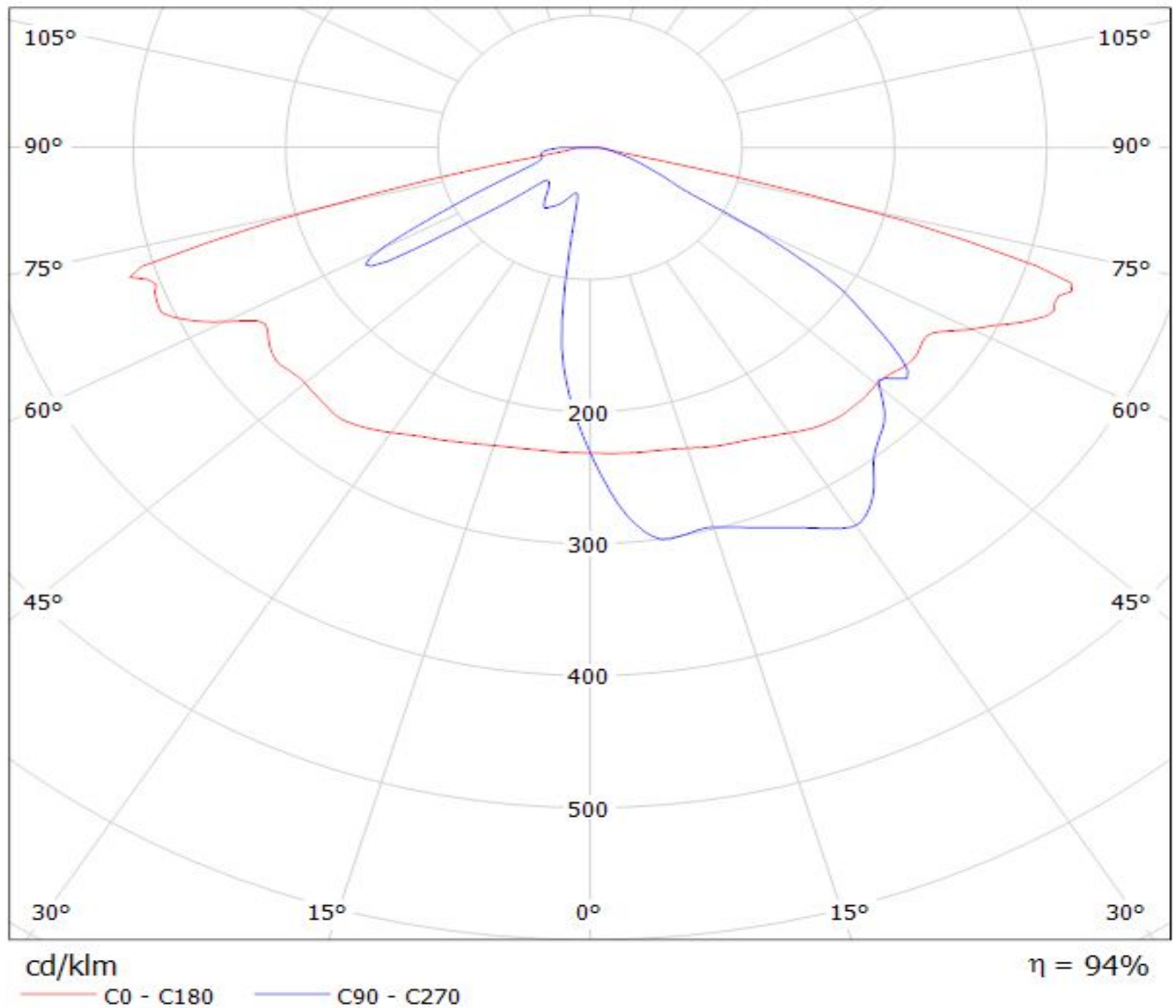

LEDiL Oy C13301_STRADA-2X2-T3_(XP-G2) Eff.92.0% / LDC (Polar)

Luminaire: LEDiL Oy C13301_STRADA-2X2-T3_(XP-G2) Eff.92.0%

Lamps: 1 x CREE XP-G2 (433lm@250mA)

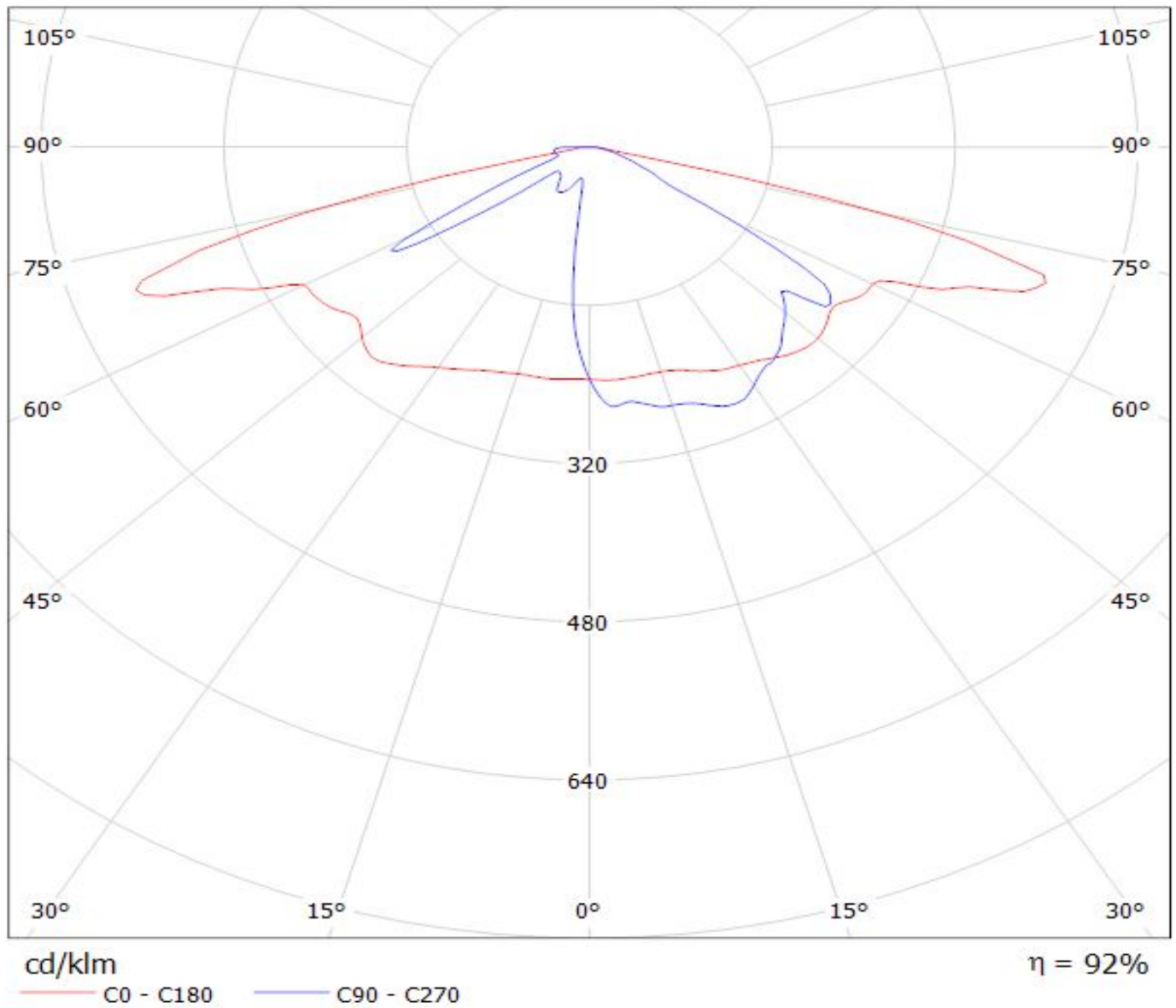

Luminaire: LEDiL Oy C13301_STRADA-2X2-T3_(Luxeon_TX)
Lamps: 1 x Luxeon_TX_2x2_321.384lm@250mA_P=2.79488W_I=249.9mA

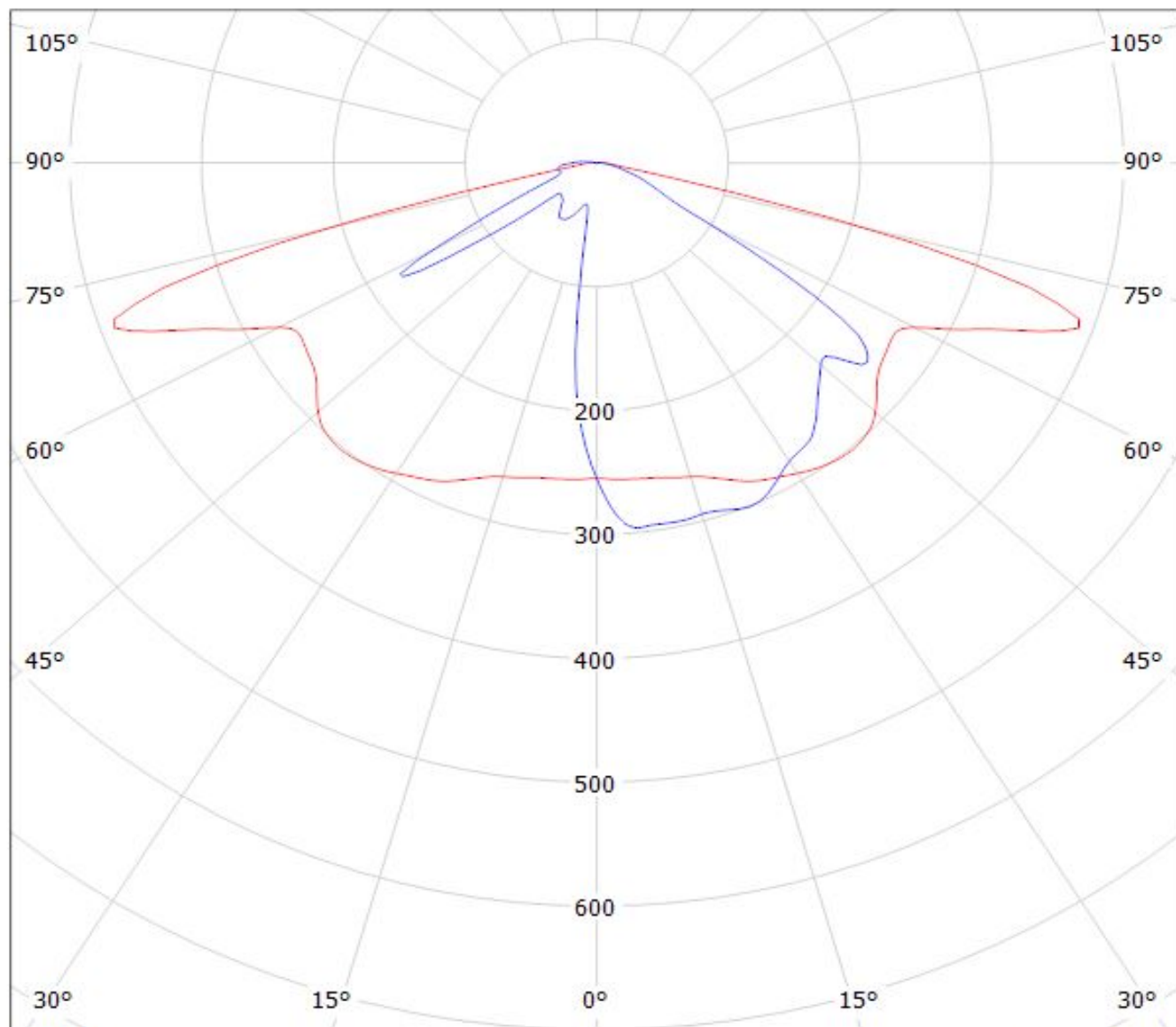

cd/klm

— C0 - C180

— C90 - C270

$\eta = 94\%$

LEDiL Oy C13301_STRADA-2x2-T3_(N383) Eff.95.9% / LDC (Polar)

Luminaire: LEDiL Oy C13301_STRADA-2x2-T3_(N383) Eff.95.9%

Lamps: 1 x NICHIA_NS9x383 (287.074lm@250mA)

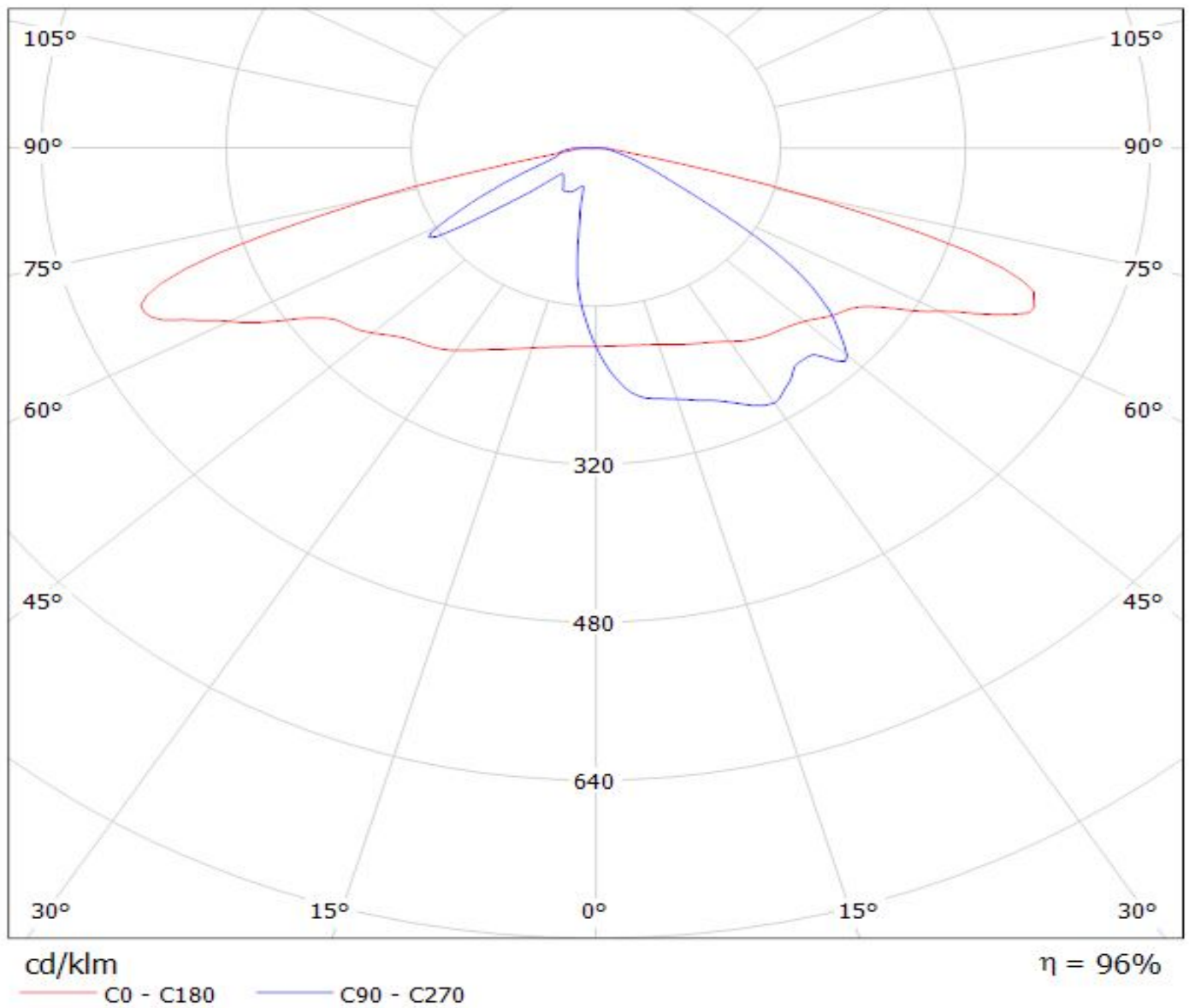

LEDiL Oy C13301_STRADA-2X2-T3_(3535) Eff.94.0% / LDC (Polar)

Luminaire: LEDiL Oy C13301_STRADA-2X2-T3_(3535) Eff.94.0%
Lamps: 1 x Samsung_3535 (343lm@250mA)

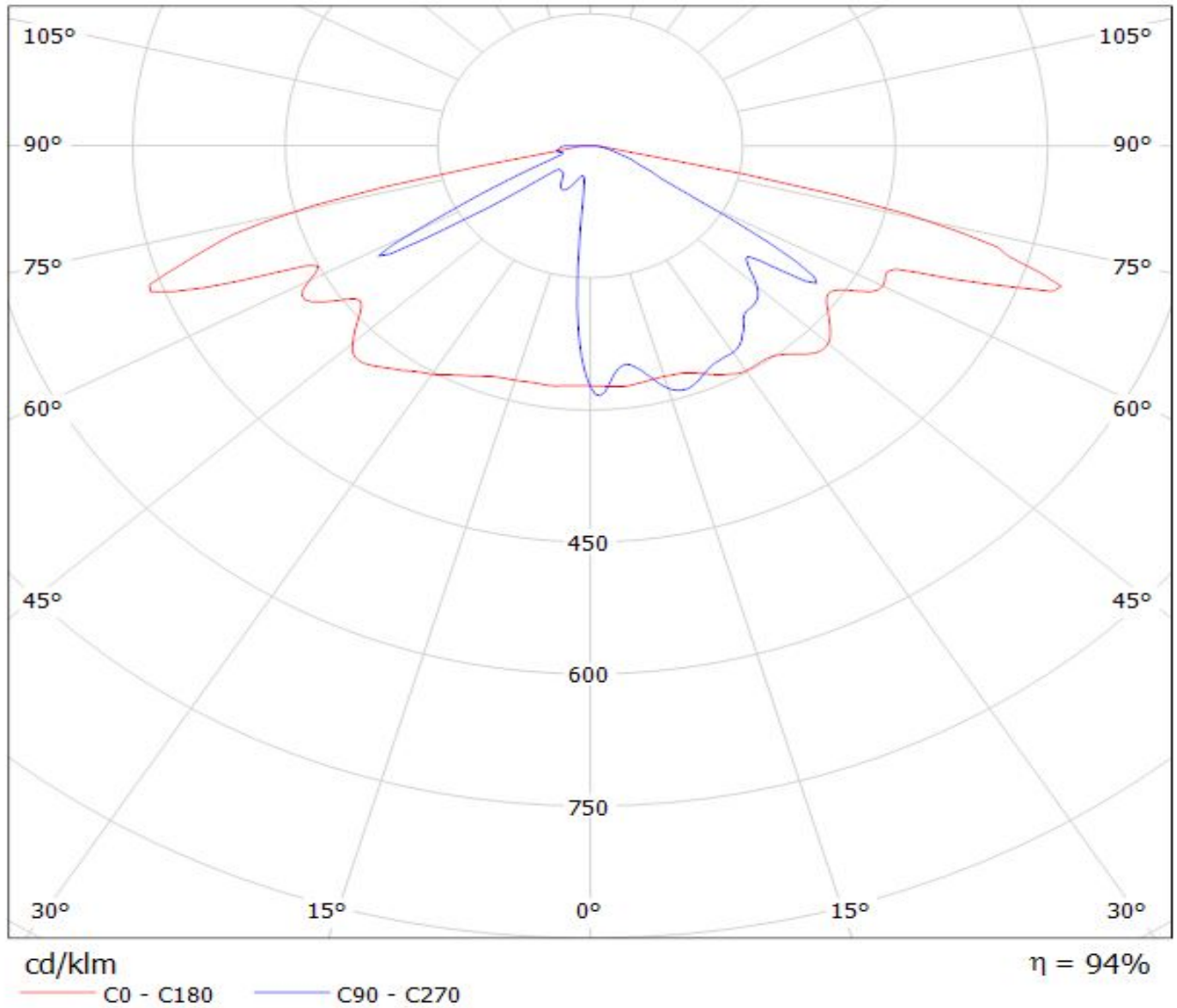

LEDiL Oy C13301_STRADA-2X2-T3_(Nichia_219B) Eff.94.4% / LDC (Polar)

Luminaire: LEDiL Oy C13301_STRADA-2X2-T3_(Nichia_219B) Eff.94.4%

Lamps: 1 x Nichia_219B (310lm@250mA)

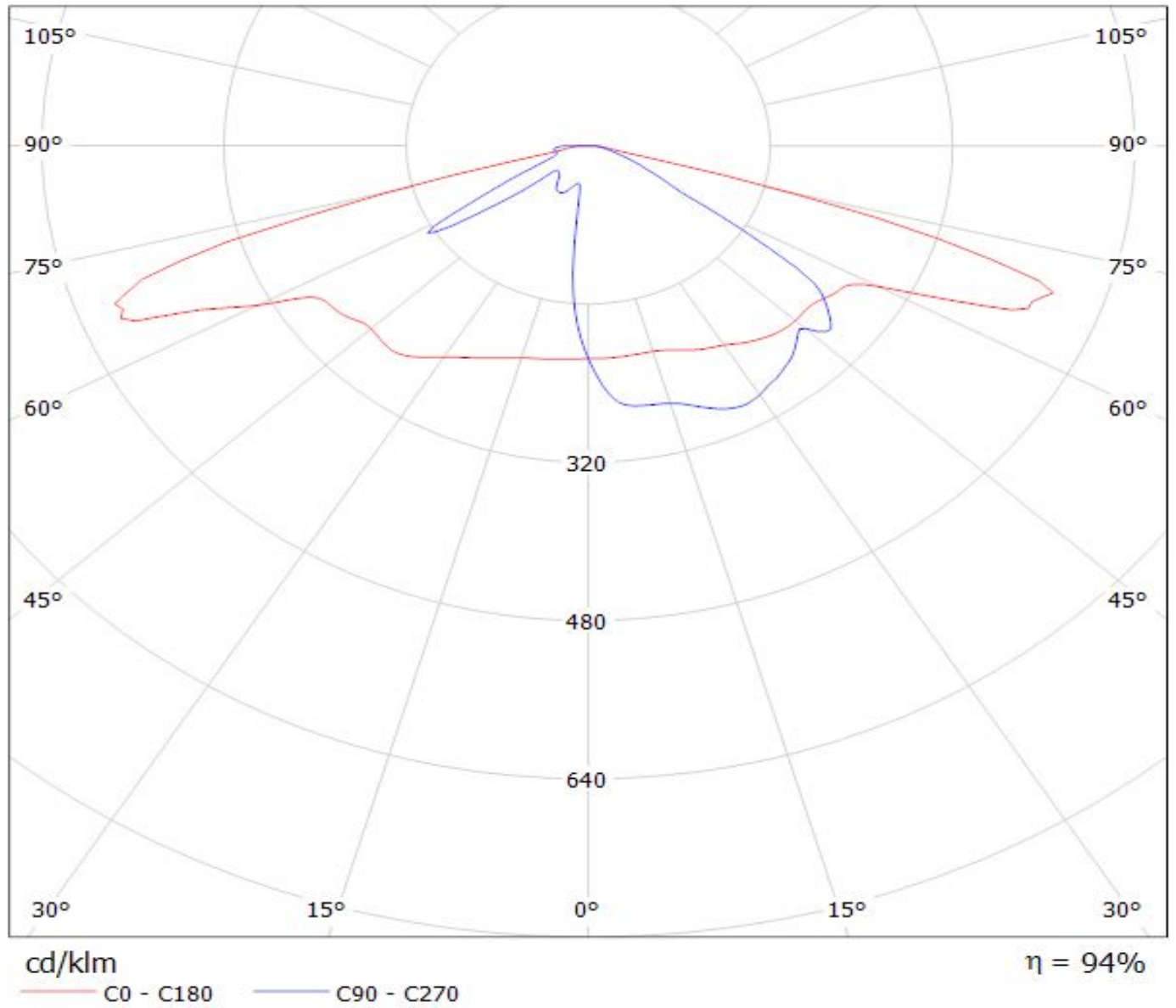

LEDiL Oy C13301_STRADA-2X2-T3_(SSL80) Eff.95.0% / LDC (Polar)

Luminaire: LEDiL Oy C13301_STRADA-2X2-T3_(SSL80) Eff.95.0%

Lamps: 1 x Oslon_SSL80 (311lm@250mA)

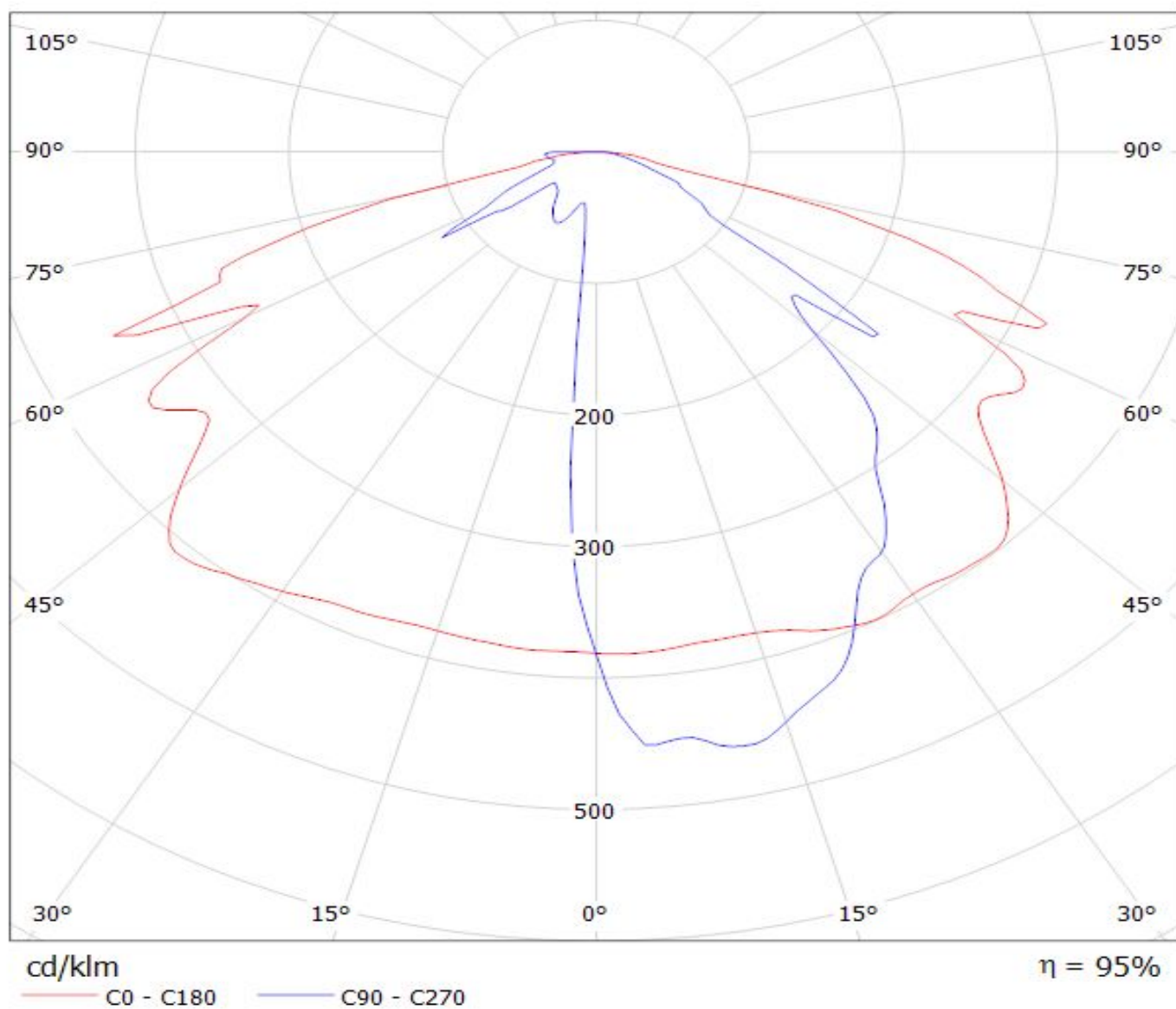

LEDiL Oy C13301_STRADA-2X2-T3_(LG_3535) Eff.94.4% / LDC (Polar)

Luminaire: LEDiL Oy C13301_STRADA-2X2-T3_(LG_3535) Eff.94.4%

Lamps: 1 x LG_3535_Ceramic_2x2 (374lm@250mA)

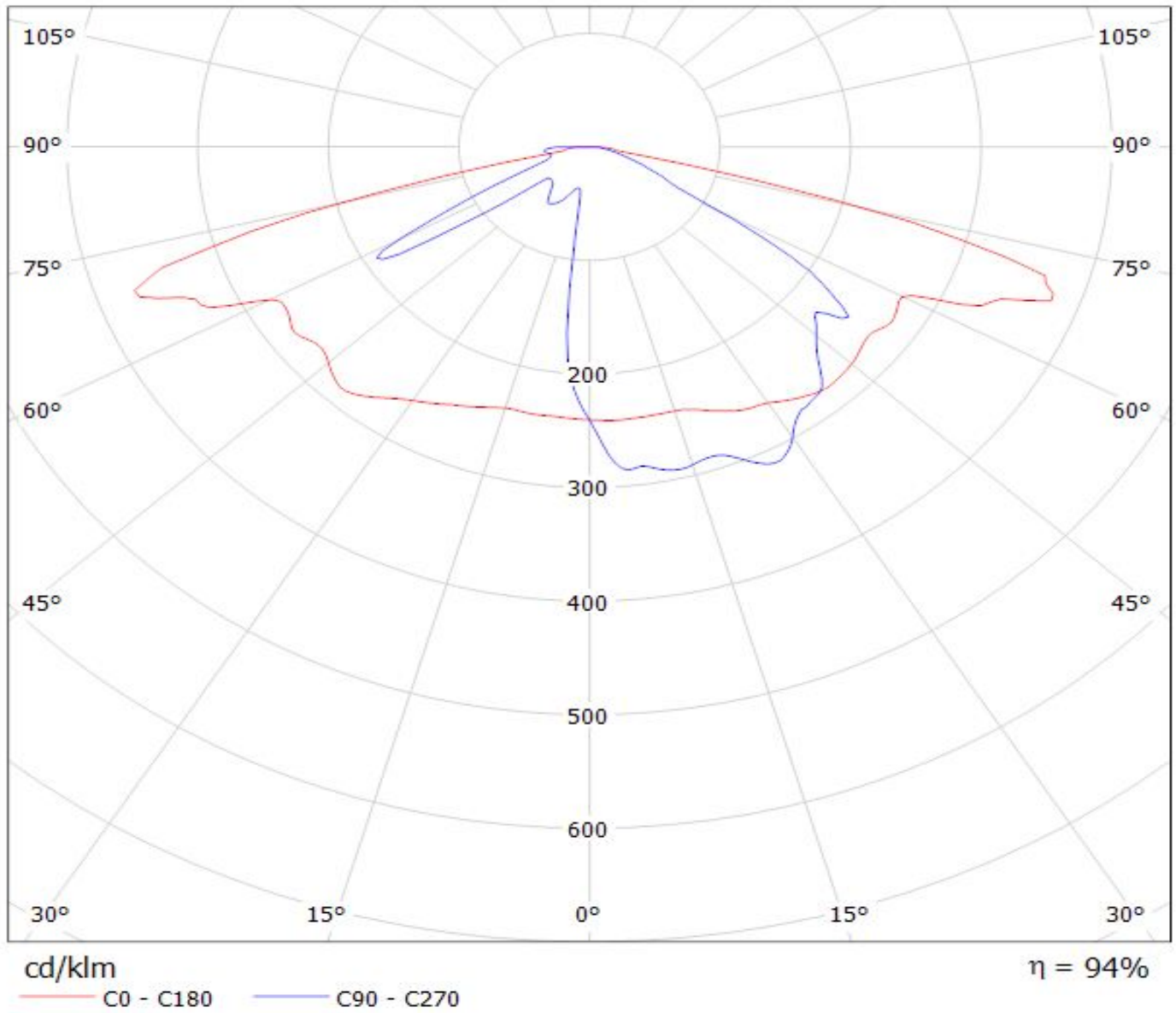

**LEDiL Oy C13301_STRADA-2X2-T3_(LG-3535-CERAMIC-GEN2) Eff.94.0% / LDC
(Polar)**

Luminaire: LEDiL Oy C13301_STRADA-2X2-T3_(LG-3535-CERAMIC-GEN2) Eff.94.0%
Lamps: 1 x LG-3535-CERAMIC-GEN2_2x2_475.25lm@250mA_P=2.8651W_CCT=6562K_I=249.9mA

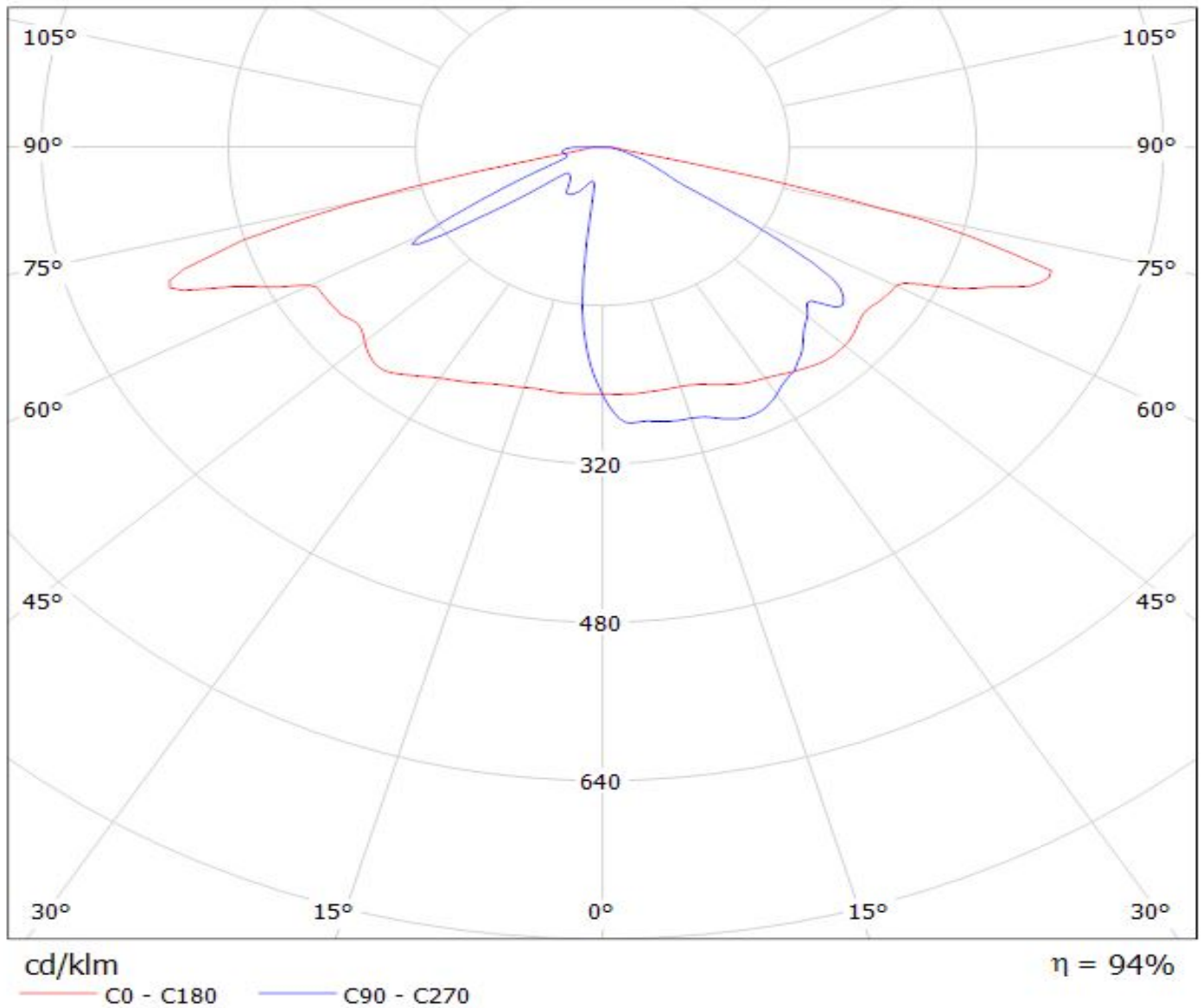

Luminaire: LEDiL Oy C13301_STRADA-2X2-T3_(Luxeon-Z-ES) Eff. 94%
Lamps: 1 x Luxeon Z ES 2x2 (LXZ2-3090) 209.277lm@250mA_P=2.81W_I=0.2499A

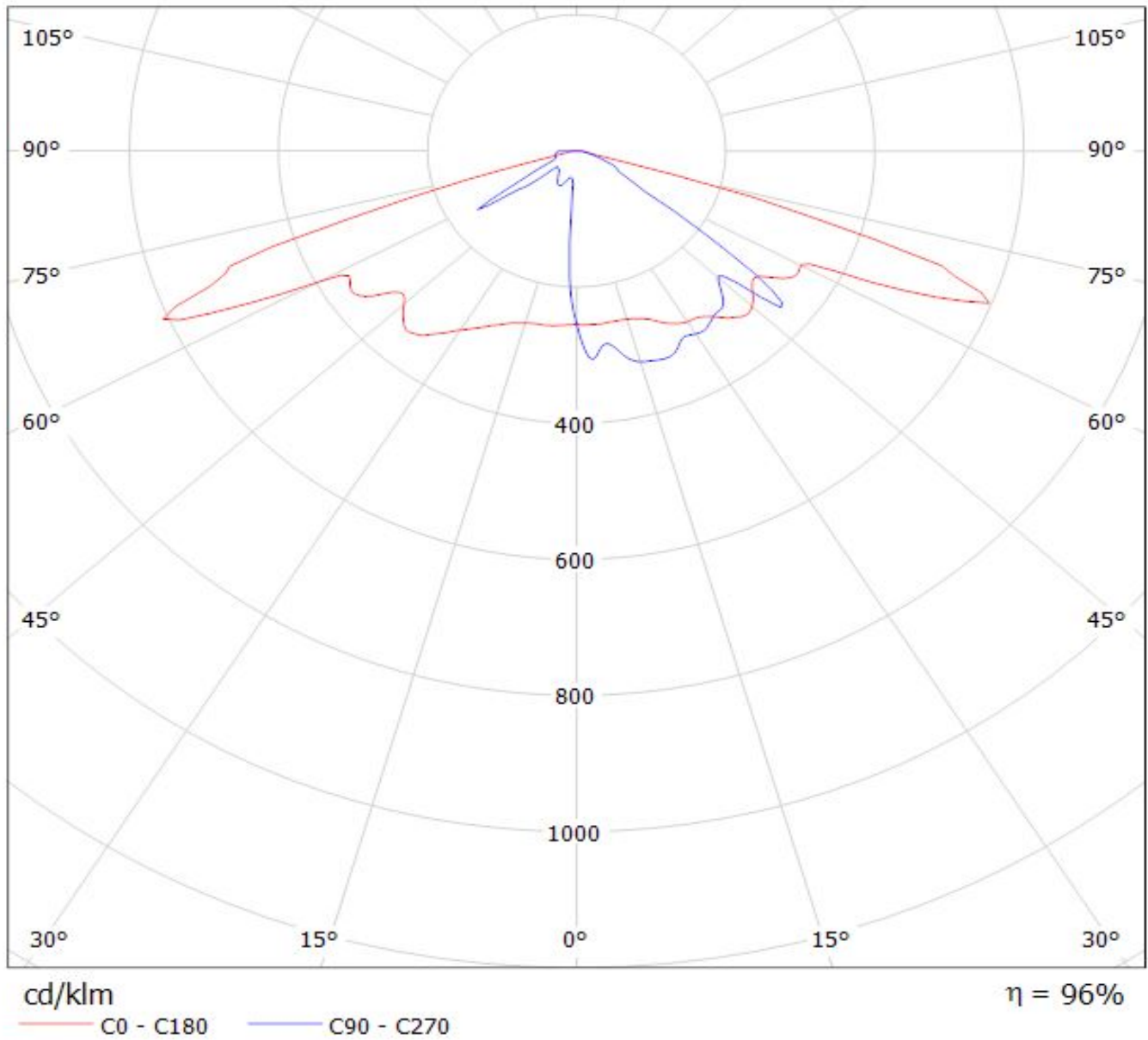

LEDiL Oy C13301_STRADA-2X2-T3_(Z5M) Eff.94.0% / LDC (Polar)

Luminaire: LEDiL Oy C13301_STRADA-2X2-T3_(Z5M) Eff.94.0%

Lamps: 1 x SEOUL_Z5M_(SZ5-M0-W0-00)_362.8lm@250mA_P=2.95788W_I=249.8mA

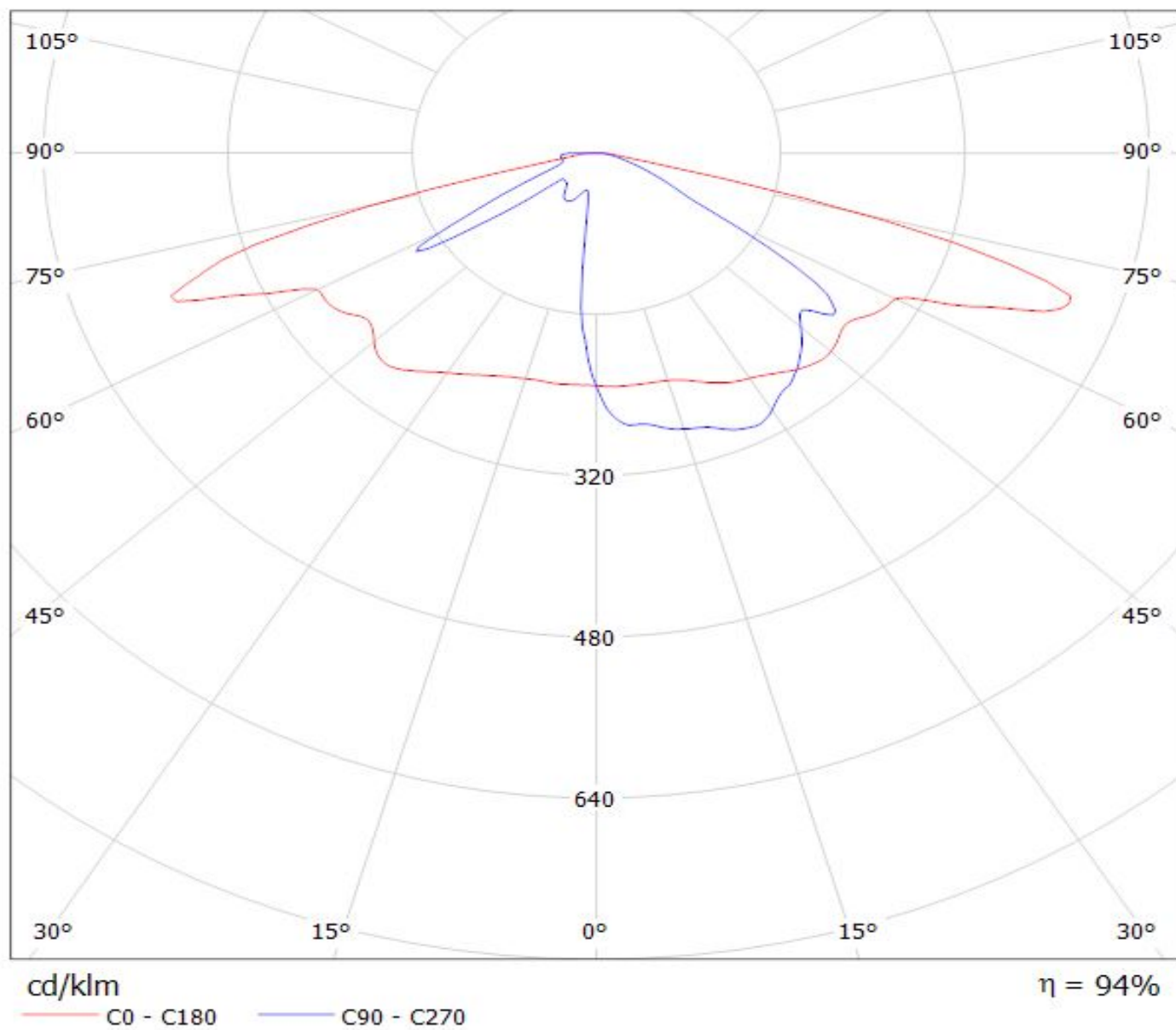

Luminaire: LEDiL Oy C13301_STRADA-2x2-T3_(XP-L)

Lamps: 1 x CREE_XP-L_2x2_(XPLAWT-0-1B0-V40-00-0001)_514lm@250mA_CCT=7600K_P=2.79963W_I=249.9mA

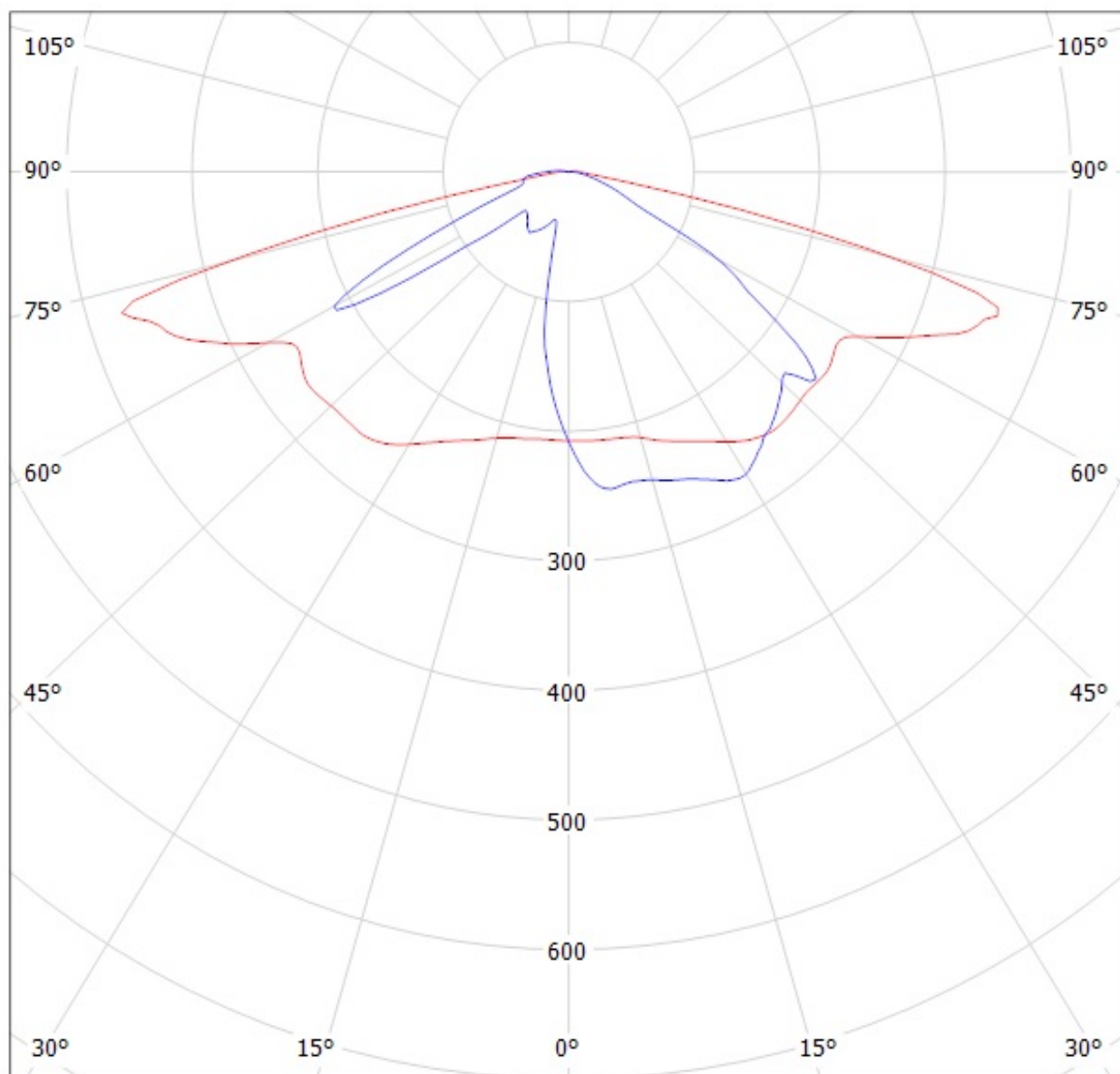

cd/klm

— C0 - C180 — C90 - C270

$\eta = 94\%$

LEDiL Oy C13301_STRADA-2x2-T3_(MJT4040) Eff.94.0% / LDC (Polar)

Luminaire: LEDiL Oy C13301_STRADA-2x2-T3_(MJT4040) Eff.94.0%

Lamps: 1 x SEOUL ACHRICH MJT4040 (SAW09H0A) 258lm@40mA P=2.37W I=40mA

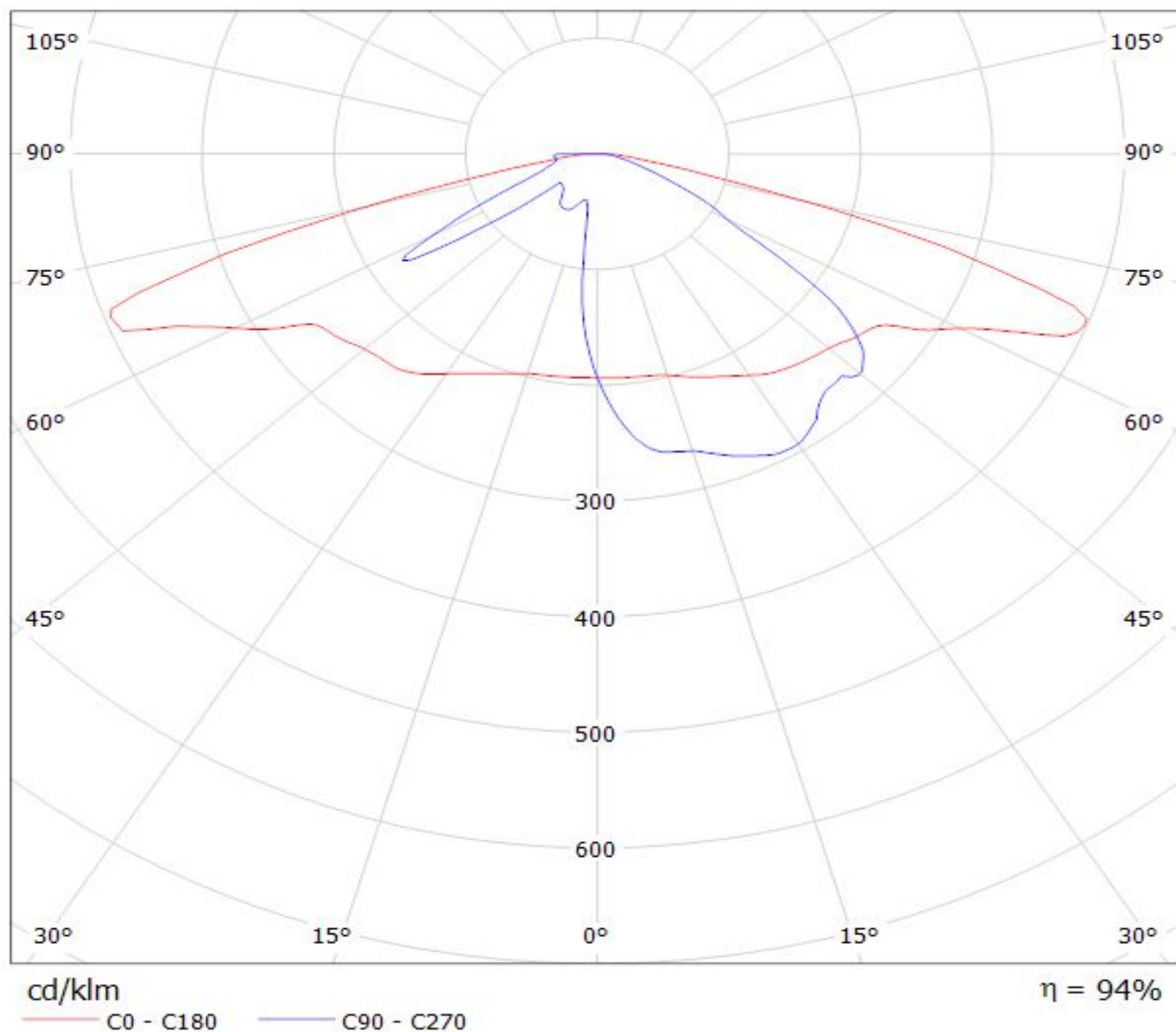

LEDiL Oy C13301_STRADA-2X2-T3_(XP-E2) Eff.94.0% / LDC (Polar)

Luminaire: LEDiL Oy C13301_STRADA-2X2-T3_(XP-E2) Eff.94.0%

Lamps: 1 x CREE_XP-E2_2x2_(XPEBWT-L1-7B4-Q4-0-01)

_340.57lm@250mA_P=2.92366W_I=249.8mA

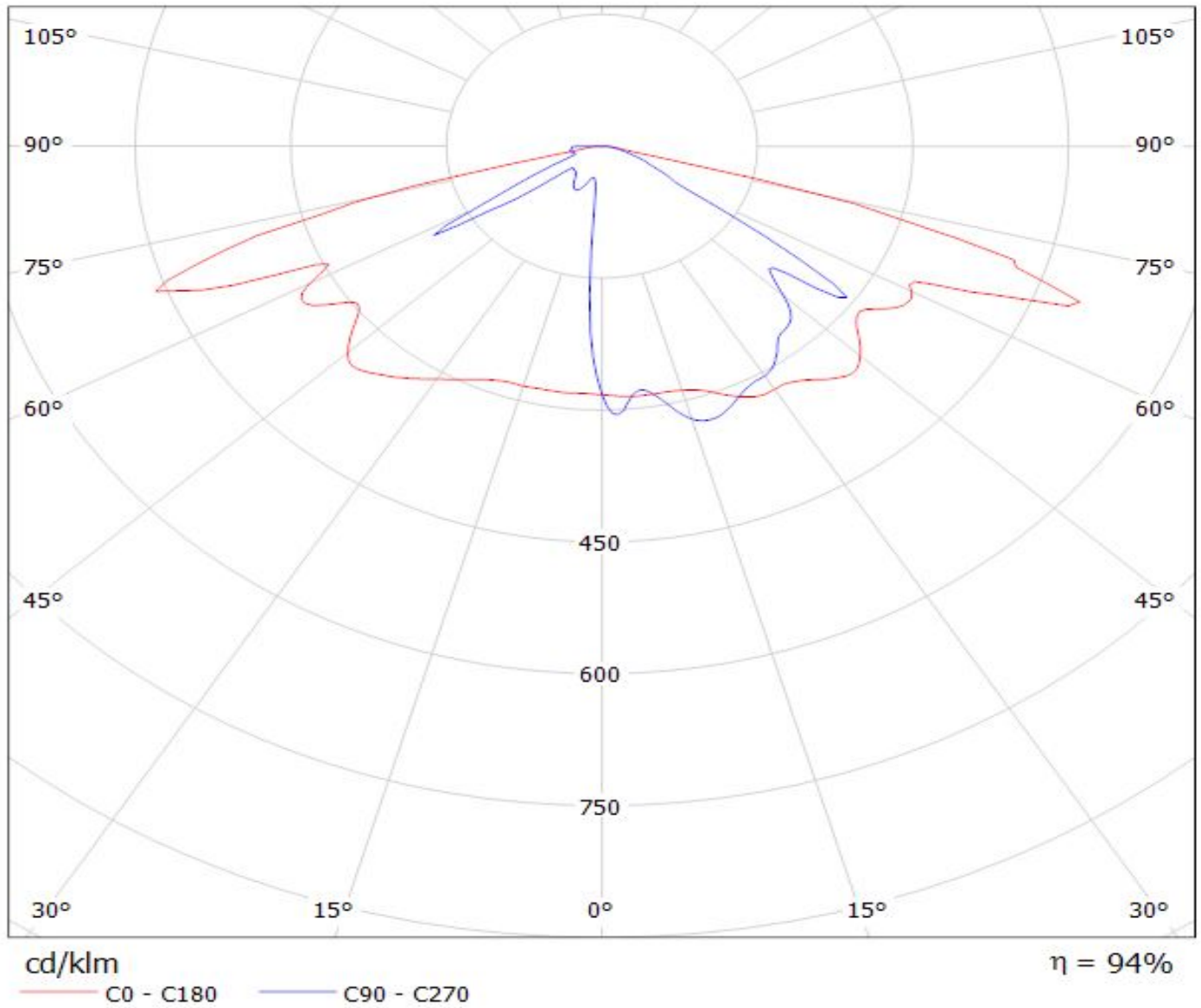

NOTE: The typical divergence will be changed by different color, chip size and chip position tolerance. The typical total divergence is the full angle measured where the luminous intensity is half of the peak value.