

Agilent U8030A Series Triple Output DC Power Supply

User's Guide



Agilent Technologies

Notices

© Agilent Technologies, Inc., 2011-2012

No part of this manual may be reproduced in any form or by any means (including electronic storage and retrieval or translation into a foreign language) without prior agreement and written consent from Agilent Technologies, Inc. as governed by United States and international copyright laws.

Manual Part Number

U8031-90004

Edition

Third Edition, August 3, 2012

Agilent Technologies, Inc.
5301, Stevens Creek Blvd.
Santa Clara, CA 95051 USA

Warranty

The material contained in this document is provided “as is,” and is subject to change, without notice, in future editions. Further, to the maximum extent permitted by the applicable law, Agilent disclaims all warranties, either express or implied, with regard to this manual and any information contained herein, including but not limited to the implied warranties of merchantability and fitness for a particular purpose. Agilent shall not be liable for errors or for incidental or consequential damages in connection with the furnishing, use, or performance of this document or of any information contained herein. Should Agilent and the user have a separate written agreement with warranty terms covering the material in this document that conflict with these terms, the warranty terms in the separate agreement shall control.

Technology Licenses

The hardware and/or software described in this document are furnished under a license and may be used or copied only in accordance with the terms of such license.

Restricted Rights Legend

U.S. Government Restricted Rights. Software and technical data rights granted to the federal government include only those rights customarily provided to end user customers. Agilent provides this customary commercial license in Software and technical data pursuant to FAR 12.211 (Technical Data) and 12.212 (Computer Software) and, for the Department of Defense, DFARS 252.227-7015 (Technical Data - Commercial Items) and DFARS 227.7202-3 (Rights in Commercial Computer Software or Computer Software Documentation).

Safety Notices

CAUTION









A **CAUTION** notice denotes a hazard. It calls attention to an operating procedure, practice, or the likes of that, if not correctly performed or adhered to, could result in damage to the product or loss of important data. Do not proceed beyond a **CAUTION** notice until the indicated conditions are fully understood and met.

WARNING

A **WARNING** notice denotes a hazard. It calls attention to an operating procedure, practice, or the likes of that, if not correctly performed or adhered to, could result in personal injury or death. Do not proceed beyond a **WARNING** notice until the indicated conditions are fully understood and met.

Safety Symbols

The following symbols on the instrument and in the documentation indicate precautions which must be taken to maintain safe operation of the instrument.

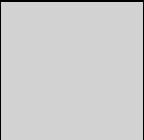
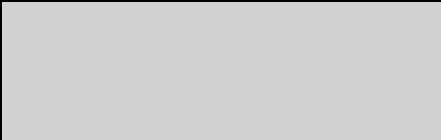
	<p>Caution, risk of danger (refer to this manual for specific Warning or Caution information)</p>		<p>In position of a bi-stable push control</p>
	<p>DC (Direct current or voltage)</p>		<p>Terminal is at earth potential. Used for measurement and control circuits designed to be operated with one terminal at earth potential.</p>
	<p>AC (Alternating current or voltage)</p>		<p>Positive binding post</p>
	<p>Protective conductor terminal</p>		<p>Negative binding post</p>
	<p>Out position of a bi-stable push control</p>		

Safety Considerations

Read the information below before using this instrument.

The following general safety precautions must be observed during all phases of operation, service, and repair of this instrument. Failure to comply with these precautions or with specific warnings elsewhere in this manual violates safety standards for design, manufacture, and intended use of the instrument. Agilent Technologies assumes no liability for the customer's failure to comply with these requirements.

CAUTION

- Use the device with the cables provided with the shipment.
 - If the device is used in a manner not specified by the manufacturer, the device protection may be impaired.
 - Always use dry cloth to clean the device. Do not use ethyl alcohol or any other volatile liquid to clean the device.
 - Do not permit any blockage of the ventilation holes of the device.
-

WARNING

- **Do not use the device if it appears damaged or defective.**
 - **Do not operate the device around flammable gases or fumes, vapor, or wet environments.**
 - **Observe all markings on the device before connecting any wiring to the device.**
 - **Turn off the output of the power supply before connecting to the output terminals.**
 - **When servicing the device, use only the specified replacement parts.**
 - **Do not install substitute parts or perform any unauthorized modification to the device.**
 - **Do not operate the device with the cover removed or loosened.**
 - **Use only the power adapter provided by the manufacturer to avoid any unexpected hazards.**
-

Environmental Conditions

This instrument is designed for indoor use and in an area with low condensation. The table below shows the general environmental requirements for this instrument.





Environmental condition	Requirements
Operating temperature	0 °C to 40 °C
Storage temperature	-40 °C to 70 °C
Humidity	15% RH (relative humidity) to 85% RH at 40 °C (non-condensing)
Altitude	Up to 2000 meters
Installation category	Installation Category II
Pollution degree	Pollution Degree 2

NOTE

The U8030A Series Triple Output DC Power Supply complies with the following safety and EMC requirements:

- IEC61326-1:2005 / EN61326-1:2006
- CISPR 11:2003/ EN55011:2007
- Canada: ICES/NMB-001: Issue 4, June 2006
- Australia / New Zealand: AS/NZS CISPR11:2004
- IEC 61010-1:2001 / EN 61010-1:2001 (2nd Edition)
- Canada: CAN/CSA-C22.2 No. 61010-1-04
- USA: ANSI/UL 61010-1:2004

Regulatory Markings

	<p>The CE mark is a registered trademark of the European Community. This CE mark shows that the product complies with all the relevant European Legal Directives.</p>		<p>The C-tick mark is a registered trademark of the Spectrum Management Agency of Australia. This signifies compliance with the Australia EMC Framework regulations under the terms of the Radio Communication Act of 1992.</p>
<p>ICES/NMB-001</p>	<p>ICES/NMB-001 indicates that this ISM device complies with the Canadian ICES-001. Cet appareil ISM est conforme a la norme NMB-001 du Canada.</p>		<p>This instrument complies with the WEEE Directive (2002/96/EC) marking requirement. This affixed product label indicates that you must not discard this electrical or electronic product in domestic household waste.</p>
	<p>The CSA mark is a registered trademark of the Canadian Standards Association.</p>		<p>This symbol indicates the time period during which no hazardous or toxic substance elements are expected to leak or deteriorate during normal use. Forty years is the expected useful life of the product.</p>

Waste Electrical and Electronic Equipment (WEEE) Directive 2002/96/EC

This instrument complies with the WEEE Directive (2002/96/EC) marking requirement. This affixed product label indicates that you must not discard this electrical or electronic product in domestic household waste.

Product Category:

With reference to the equipment types in the WEEE directive Annex 1, this instrument is classified as a “Monitoring and Control Instrument” product.

The affixed product label is as shown below.



Do not dispose in domestic household waste.

To return this unwanted instrument, contact your nearest Agilent Service Center, or visit

www.agilent.com/environment/product

for more information.

Declaration of Conformity (DoC)

The Declaration of Conformity (DoC) for this instrument is available on the Agilent website. You can search the DoC by its product model or description at the web address below.

<http://regulations.corporate.agilent.com/DoC/search.htm>

NOTE

If you are unable to search for the respective DoC, please contact your local Agilent representative.

Table of Contents

1 Introduction

About This Manual	18
Documentation map	18
Safety notes	18
Preparing Your Power Supply	19
Checking the shipment	19
Connecting power to the instrument	20
Checking the instrument output	21
Rack-mounting the instrument	24
Enabling or disabling the backlight	25
Your Power Supply in Brief	26
Dimensions	26
Overview	27
Display screen	30
Output connections	33
Operating Your Power Supply	34
Cooling	34
Bench operation	34
Cleaning	34
List of Error Codes	35
System errors	35
Power channel errors	35

2 Operation and Features

Constant Voltage Operation	38
Constant Current Operation	40
5 V Operation	42
Overload condition	42

Circuit fault condition	43
Track Mode Operation	44
Output On/Off Operation	45
Turn on or off all outputs	45
Turn on or off individual outputs	46
Memory Operations	47
Storing an operating state	47
Recalling an operating state	48
Memory Output Operations	49
Enable the memory output single operation	49
Enable the memory output loop operation	50
Program the memory output time interval	51
Programming the Overvoltage Protection	52
Set the OVP trip level and enable the OVP	52
Disable the OVP	53
Clear the overvoltage condition	53
Programming the Overcurrent Protection	55
Set the OCP trip level and enable the OCP	55
Disable the OCP	56
Clear the overcurrent condition	56
Keylock Operation	58
System-Related Operations	59
Reset to the factory defaults	59
Power-on self-test	59
Display the firmware and board versions	60
Extending the Voltage and Current Range	61
Series connection	61
Parallel connection	62

3 Characteristics and Specifications

Electrical Specifications 66

Physical Characteristics 67

Supplemental Characteristics 68

Protection Features 69

AC Power Input Specifications 69

Environmental Specifications 70

Connection Specifications 70

List of Figures

Figure 1-1	Rack-mount adapter kit	24
Figure 1-2	U8030A Series rack-mount dimensions	24
Figure 1-3	U8030A Series dimensions	26
Figure 1-4	The front panel at a glance	27
Figure 1-5	The rear panel at a glance	29
Figure 1-6	The LCD display at a glance	30
Figure 2-1	Connecting units in series	62
Figure 2-2	Connecting units in parallel	63

List of Tables

Table 1-1	List of rated fuse for line voltages	21
Table 1-2	Front panel legends and descriptions	27
Table 1-3	Rear panel legends and descriptions	30
Table 1-4	LCD display legends and descriptions	31
Table 1-5	List of system error codes	35
Table 1-6	List of power channel error codes	35
Table 3-1	Electrical specifications	66
Table 3-2	Physical characteristics	67
Table 3-3	Supplemental characteristics	68
Table 3-4	Protection features	69
Table 3-5	AC power input specifications	69
Table 3-6	Environmental specifications	70
Table 3-7	Connection specifications	70

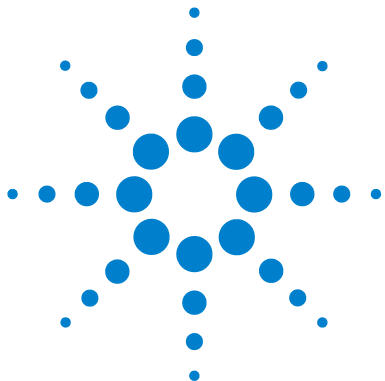

1 Introduction

About This Manual	18
Documentation map	18
Safety notes	18
Preparing Your Power Supply	19
Checking the shipment	19
Connecting power to the instrument	20
Checking the instrument output	21
Rack-mounting the instrument	24
Enabling or disabling the backlight	25
Your Power Supply in Brief	26
Dimensions	26
Overview	27
Display screen	30
Output connections	33
Operating Your Power Supply	34
Cooling	34
Bench operation	34
Cleaning	34
List of Error Codes	35
System errors	35
Power channel errors	35

This chapter teaches you how to set up your power supply for the first time. An introduction to all the features of the power supply is also given.



About This Manual

The descriptions and instructions in this manual apply to the Agilent U8031A and U8032A triple output DC power supplies (hereafter referred to as the power supply).

The model U8032A appears in all illustrations.

Documentation map

The following manuals are available for your power supply. For the latest version, please visit our website at: <http://www.agilent.com/find/U8030>.

Check the manual revision on the first page of each manual.

- **User's Guide.** This manual.
- **Quick Reference Guide.** Printed copy, included with the shipment.
- **Service Guide.** Free download at the Agilent website.

Safety notes

Safety notes are used throughout this manual (see the “[Safety Notices](#)” section for format examples). Familiarize yourself with each of the notes and its meaning before operating your power supply.

More pertinent safety notes for using this product are located under the “[Safety Considerations](#)” section.

Do not proceed beyond a safety notice until the indicated conditions are fully understood and met.

Preparing Your Power Supply

Checking the shipment

When you receive your power supply, check the shipment according to the following procedure.

- 1 Inspect the shipping container for damage. Signs of damage may include a dented or torn shipping container or cushioning material that indicates signs of unusual stress or compacting. Save the packaging material in case the power supply needs to be returned.
- 2 Carefully remove the contents from the shipping container, and verify that the standard accessories and your ordered options are included in the shipment according to the standard shipped items list shown below.
- 3 For any question or problems, refer to the Agilent contact numbers on the back of this manual.

Standard shipped items

Verify that you have received the following items in the shipment of your power supply. If anything is found missing or damaged, please contact your nearest Agilent Sales Office.

- ✓ One power cord
- ✓ One printed copy of the Certificate of Calibration
- ✓ One copy of the U8030A Series Product Reference CD-ROM

Keep the original packaging in case the power supply has to be returned to Agilent in the future. If you return the power supply for service, attach a tag identifying the owner and model number. Also, include a brief description of the problem.

Connecting power to the instrument

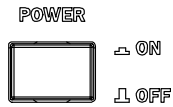

Connect the power cord to the AC power connector (see [page 29](#) for the AC power connector location).

Before connecting the mains plug, ensure that the line voltage selection is appropriate for your location (100 V, 115 V, or 230 V). The mains plug should only be inserted into a socket outlet that provides protective earth contact.

Push the power switch to turn on the instrument.

The front-panel display illuminates while the power supply performs its power-on self-test. (If the instrument does not power-on, refer to the steps below). If self-test is successful, the power supply goes into normal operation.

NOTE

The power supply is shipped from the factory with a power-line cord that has a plug appropriate for your location. Your power supply is equipped with a three-wire grounding type power cord; the third conductor being the ground. The power supply is grounded only when the power-line cord is plugged into an appropriate receptacle. Do not operate your power supply without an adequate cabinet ground connection.

If the instrument does not turn on

Use the following steps to help solve problems you might encounter when turning on the instrument. If you need more help, refer to the *U8030A Series Service Guide* for instructions on returning the instrument to Agilent Technologies for service.

1 Verify that there is AC power to the power supply.

First, verify that the power cord is firmly plugged into the power receptacle on the rear panel of the power supply.

You should also make sure that the power source you plugged the power supply into is energized. Then, verify that the power supply is turned on.

2 Verify the power-line voltage setting.

The line voltage is set to the proper value for your country when the power supply is shipped from the factory. Change the voltage setting if it is not correct. The settings are: 100, 115, or 230 VAC.

3 Verify that the correct power-line fuse is installed.

The correct fuse for your country is installed when the power supply is shipped from the factory. See the table below to replace the fuse for your power supply.

Table 1-1 List of rated fuse for line voltages

Model	Agilent part number	Part description
U8031A/ U8032A	2110-1504	FUSE 1.0 A TIME-DELAY 0.0757 Ω 20 mm \times 5.2 mm \times 5.2 mm

Checking the instrument output

The following procedures check to ensure that the power supply develops its rated outputs and properly responds to operation from the front panel. For complete performance and verification tests, refer to the *U8030A Series Service Guide*.

From the front-panel VFD (vacuum-fluorescent display), you can monitor actual values of output voltage and current (meter mode) or voltage and current limit values (limit mode).

NOTE

If an error is detected during the output checkout procedure, the **Err** annunciator will turn on. For more information, refer to the “[List of Error Codes](#)” on page 35.

Voltage output check

The following steps verify basic voltage functions with no load.

- 1 Turn on the power supply.

The power supply starts up for the first time in the power-on (reset) state – all the outputs are disabled (the **OFF** annunciator is turned on).

- 2 Enable the outputs.

Press the [**All On/Off**] button once. Notice that the display is in the meter mode.

- 3 Press [**1**] or [**2**] to switch between Output 1 and Output 2 (the **OUT1** and **OUT2** annunciators will turn on and off respectively). Check that the front-panel voltmeter properly responds to the knob control for both outputs.

Turn the knob clockwise or counterclockwise to check that the voltmeter responds to the knob control and the ammeter indicates nearly zero.

- 4 Ensure that the voltage can be adjusted from zero to the full rated value by adjusting the knob.
- 5 Disable the outputs, and turn off the power supply.

NOTE

For subsequent power cycles, the power supply returns to the last power-off state (when power is applied) by default.

Current output check

The following steps verify basic current functions with a short across the power supply output.

- 1 Turn off the power supply.

- 2 Connect a short across the (+) and (-) output terminals of Output 1 with an insulated test lead.

Use a wire size sufficient to handle the maximum current (refer to the American Wire Gauge standard).

- 3** Turn on the power supply.
Ensure that all the outputs are disabled (the **OFF** annunciator is turned on).
- 4** Enable the output for Output 1.
Press the [**Output 1 On/Off**] button (the **OFF** annunciator for **OUT1** turns off). Notice that the display is in the meter mode.
- 5** Adjust the voltage limit value to 1.00 V.
Press the [**Display Limit**] button to set the display to the limit mode (the **LIMIT** annunciator turns on).
Adjust the voltage limit to 1.00 V to ensure constant current (CC) operation. The **CC** annunciator will turn on.
Press the [**Display Limit**] button again or allow the power supply to idle for a few seconds to exit the limit mode.
- 6** Check that the front-panel ammeter properly responds to the knob control for Output 1.
Press the [**Voltage/Current**] button. Ensure that the **A** annunciator is blinking before proceeding with the next step.
Turn the knob clockwise or counterclockwise when the display is in the meter mode (the **LIMIT** annunciator is off). Check that the ammeter responds to the knob control and the voltmeter indicates nearly zero (the voltmeter will show the voltage drop caused by the test lead).
- 7** Ensure that the current can be adjusted from zero to the full rated value by adjusting the knob.
- 8** Repeat [step 1](#) to [step 7](#) for Output 2. Press [**1**] or [**2**] to switch between Output 1 and Output 2 (the **OUT1** and **OUT2** annunciators will turn on and off respectively).
- 9** Disable the outputs, turn off the power supply, and remove the short from the output terminals.

1 Introduction

Preparing Your Power Supply

Rack-mounting the instrument

You can mount the power supply in a standard 19-inch rack cabinet. Instructions and mounting hardware are included with the rack-mounting kit.

To rack-mount a single instrument, order adapter kit 5063-9245.

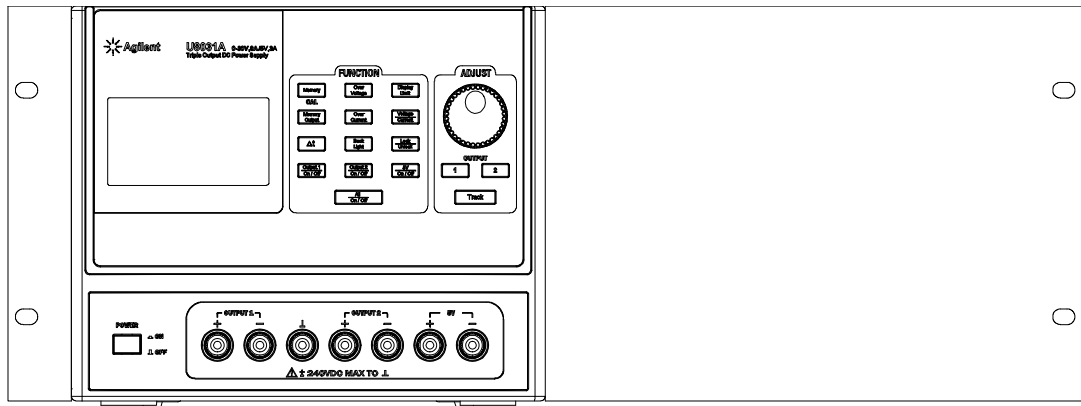

Figure 1-1 Rack-mount adapter kit

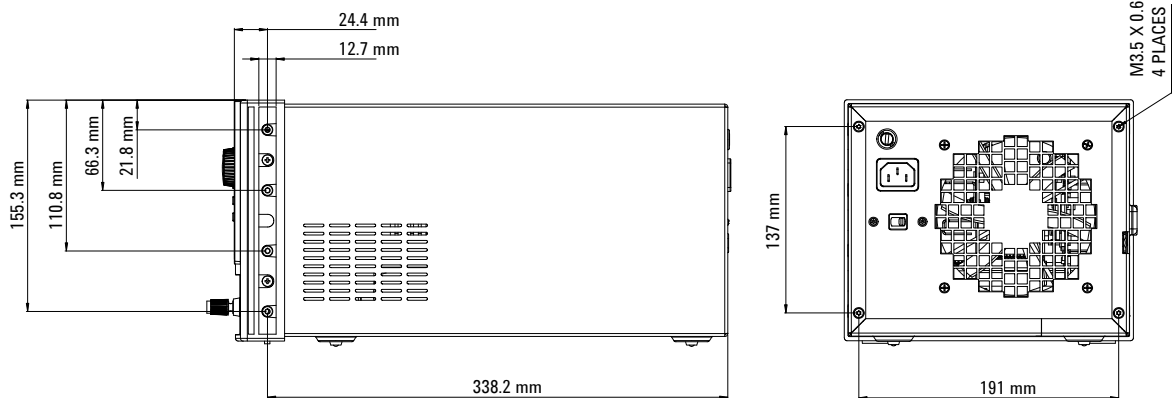

Figure 1-2 U8030A Series rack-mount dimensions

Enabling or disabling the backlight



You can enable or disable the LCD backlight through the front panel. Press the [**Back Light**] button to disable the LCD backlight.

If viewing the display becomes difficult in low-light conditions, press the [**Back Light**] button again to enable the LCD backlight.

NOTE

The LCD backlight is enabled by default upon power-on.

Your Power Supply in Brief

Dimensions

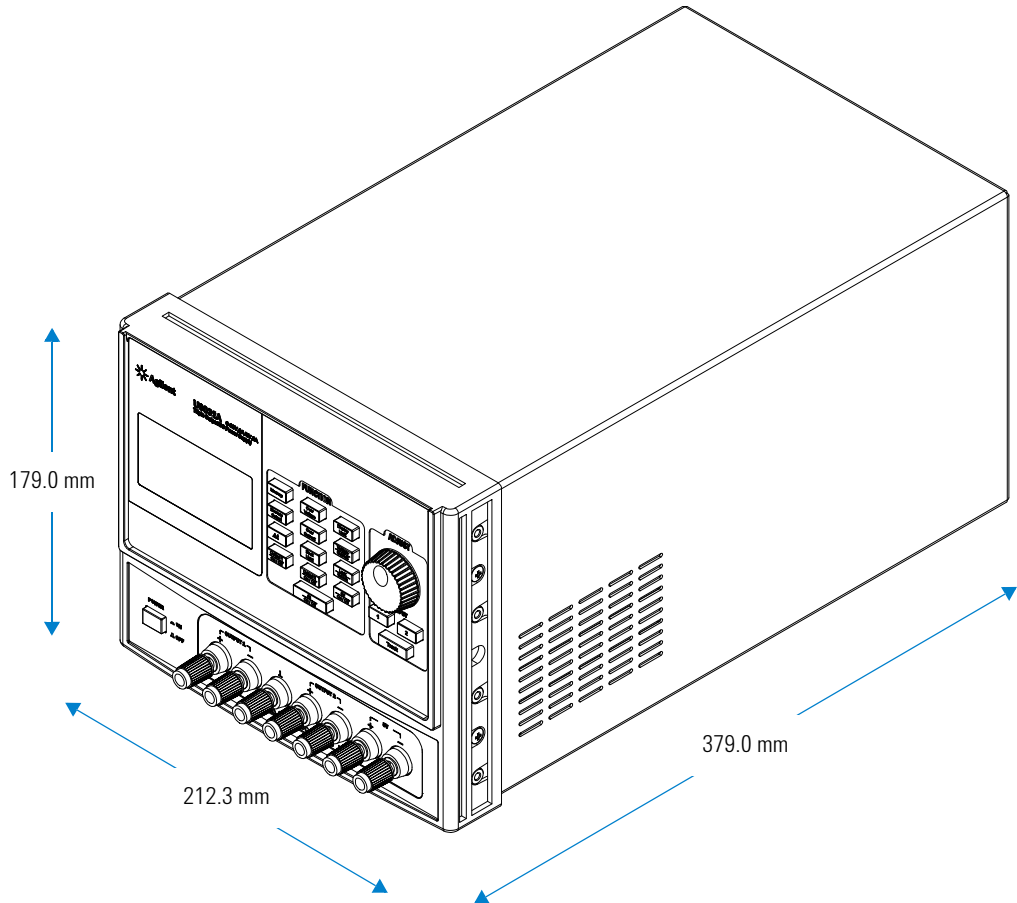

Figure 1-3 U8030A Series dimensions

Overview

Front panel

The front panel parts of your power supply are described in this section.

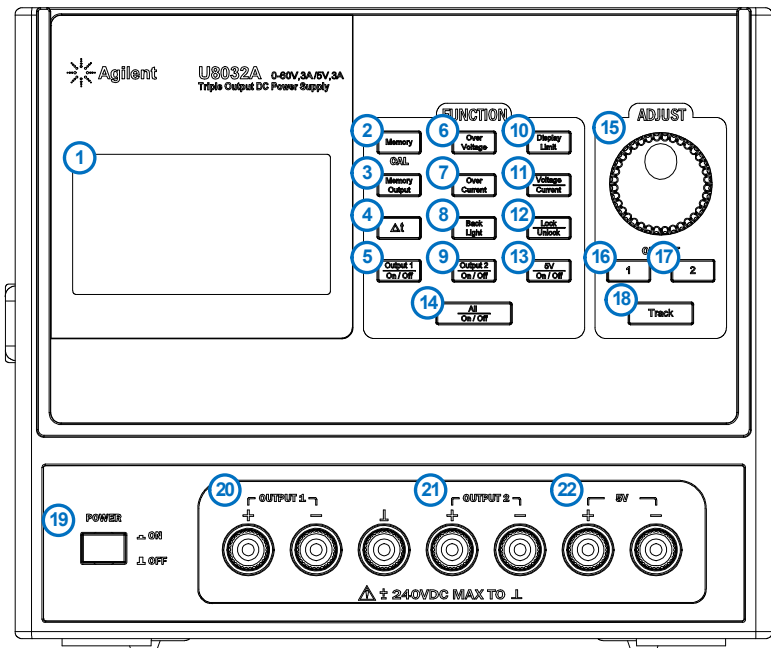

Figure 1-4 The front panel at a glance

Table 1-2 Front panel legends and descriptions

Legend	Description
1	LCD display Displays the instrument settings and readings.
2	[Memory] Stores the current operating state or recalls a previously stored operating state from the available memory locations (M1 , M2 , or M3).

Table 1-2 Front panel legends and descriptions (continued)

	Legend	Description
3	[Memory Output]	Recalls all stored operating in sequence once (single) or in a loop.
4	[Δt]	Adjusts the memory output time interval.
5	[Output 1 On/Off]	Enables or disables the power supply output from the Output 1 binding posts.
6	[Over Voltage]	Enables or disables the overvoltage protection function, sets the trip voltage level, and clears the overvoltage condition.
7	[Over Current]	Enables or disables the overcurrent protection function, sets the trip current level, and clears the overcurrent condition.
8	[Back Light]	Turns the LCD backlight on or off.
9	[Output 2 On/Off]	Enables or disables the power supply output from the Output 2 binding posts.
10	[Display Limit]	Displays and sets the voltage and current limit values.
11	[Voltage/Current]	Selects the knob control function for voltage or current adjustment.
12	[Lock/Unlock]	Enables or disables the front panel operation.
13	[5 V On/Off]	Enables or disables the power supply output from the 5 V binding posts.
14	[All On/Off]	Enables or disables the power supply output from all the binding posts (Output 1, Output 2, and 5 V).
15	Knob	Increases and decreases the value of the blinking digit on the LCD display
16	[1]	Selects the knob control function for Output 1 adjustment.
17	[2]	Selects the knob control function for Output 2 adjustment.
18	[Track]	Sets the voltage and current settings of Output 1 or Output 2 to follow each other.

Table 1-2 Front panel legends and descriptions (continued)

Legend	Description
19 [POWER]	Turns the power supply on or off.
20 Output 1 binding posts	Positive, negative, and ground (shared) binding posts for Output 1 wire connections.
21 Output 2 binding posts	Positive, negative, and ground (shared) binding posts for Output 2 wire connections.
22 5 V binding posts	Positive and negative binding posts for 5 V output wire connections.

Rear panel

The rear panel parts of your power supply are described in this section.

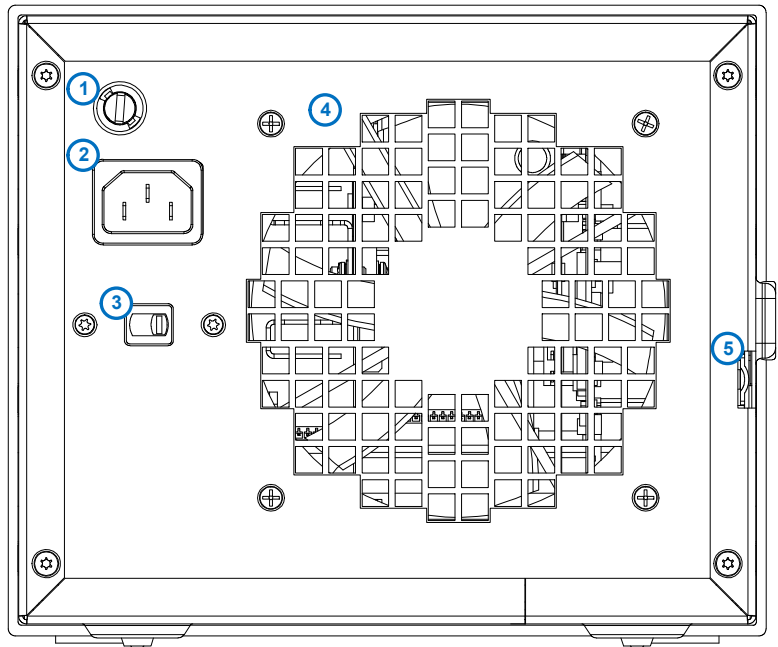

Figure 1-5 The rear panel at a glance

Table 1-3 Rear panel legends and descriptions

Legend	Description
1 AC line fuse	To maintain protection, replace this fuse only with a fuse of the specified type and rating.
2 AC inlet	Connects the AC power line. Plug the power cord firmly in here.
3 Line voltage and fuse rating selector	Set the line voltage and line fuse rating to the proper values that are appropriate for your location.
4 Ventilation fan	Ventilation fan to exhaust heat and air from the instrument.
5 Physical lock mechanism	Enables the physical lock mechanism.

Display screen

The display annunciators of your power supply are described in this section.

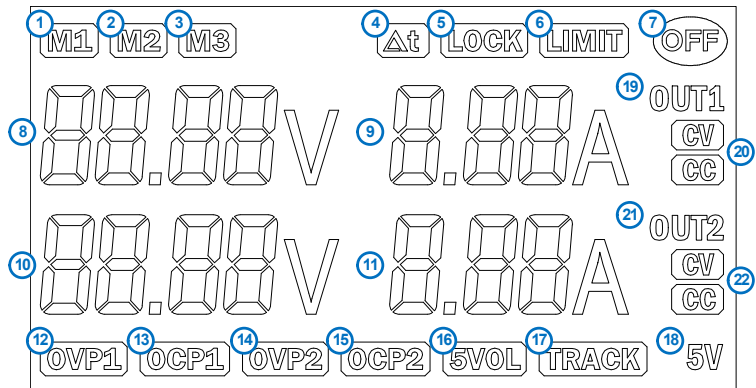

Figure 1-6 The LCD display at a glance

Table 1-4 LCD display legends and descriptions

Legend	Description
1 M1	Stores the current power supply operating state in the power supply non-volatile memory.
2 M2	When the power supply is in the calibration mode, these states can be used to store the calibration constants.
3 M3	
4 Δt	
5 LOCK	Front panel operation is disabled.
6 LIMIT	The voltage and current limit values are shown in the display.
7 OFF	All the power supply outputs are disabled.
8 88.88 V	Line 1: Voltage and current values display for Output 1.
9 8.88 A	
10 88.88 V	Line 2: Voltage and current values display for Output 2.
11 8.88 A	
12 OVP1	When the OVP1 annunciator is steady, the overvoltage protection function for Output 1 is enabled. When the OVP1 annunciator is blinking, an overvoltage condition has occurred. The power supply output is disabled until the trip is cleared.
13 OCP1	When the OCP1 annunciator is steady, the overcurrent protection function for Output 1 is enabled. When the OCP1 annunciator is blinking, an overcurrent condition has occurred. The power supply output is disabled until the trip is cleared.

Table 1-4 LCD display legends and descriptions

Legend	Description
14 OVP2	When the OVP2 annunciator is steady, the overvoltage protection function for Output 2 is enabled.
	When the OVP2 annunciator is blinking, an overvoltage condition has occurred. The power supply output is disabled until the trip is cleared.
15 OCP2	When the OCP2 annunciator is steady, the overcurrent protection function for Output 2 is enabled.
	When the OCP2 annunciator is blinking, an overcurrent condition has occurred. The power supply output is disabled until the trip is cleared.
16 5VOL	An overload condition has occurred in the 5 V output channel. The power supply output is disabled until the trip is cleared.
17 TRACK	The track operation is active.
18 5 V	The power supply is supplying a constant voltage of 5 V from the 5 V binding posts.
19 OUT1	Output 1 is selected.
20	CV The power supply is supplying constant voltage from the Output 1 binding posts.
	CC The power supply is supplying constant current from the Output 1 binding posts.
21 OUT2	Output 2 is selected.
22	CV The power supply is supplying constant voltage from the Output 2 binding posts.
	CC The power supply is supplying constant current from the Output 2 binding posts.

Output connections

WARNING

Before attempting to connect wires to the front output terminals, make sure to disable the power supply output first to avoid damage to the circuits being connected.

Voltage drops

The load wires must be large enough to avoid excessive voltage drops due to the impedance of the wires. In general, if the wires are heavy enough to carry the maximum short circuit current without overheating, excessive voltage drops will not be a problem. The voltage drops across the load wires should be limited to less than 2 V. Refer to the American Wire Gauge (AWG) standard to calculate the voltage drop for some commonly used AWG wire copper.

Operating Your Power Supply

Cooling

The power supply can operate at rated specifications within the temperature range of 0 °C to 40 °C. Power supply loading is derated from 40 °C to 55 °C. A fan cools the power supply by drawing air through the sides and exhausting it out the back. Using an Agilent rack-mount will not impede the flow of air.

Bench operation

Your power supply must be installed in a location that allows sufficient space at the sides and rear of the power supply for adequate air circulation.

Cleaning

No cleaning is required for this product. If you wish to remove dust from the enclosure, use a dry cloth.

List of Error Codes

The following errors indicate failures that may occur while operating the power supply.

System errors

Table 1-5 List of system error codes

Error code	Description
001	Failed firmware test
002	Failed RAM test
003	Flash read/write error

Power channel errors

Table 1-6 List of power channel error codes

Error code	Description
104	EEPROM write error
105	Analog board firmware update error
106	Analog board firmware checksum error
107	EEPROM read error
108	Failed to calibrate voltage DAC
109	Failed to calibrate voltage ADC
110	Failed to calibrate OVP
111	Failed to calibrate current DAC
112	Failed to calibrate current ADC

Table 1-6 List of power channel error codes (continued)

Error code	Description
113	Failed to calibrate OCP
119	Analog board unknown error
120	Over temperature
130	Failed EEPROM test
131	Failed voltage +15 V
132	Failed voltage +5 V
133	Failed voltage +2.5 V _{REF}
134	Failed voltage +1 V _{REF}
135	Failed ADC test
136	Failed DAC test
140	Failed communication with analog board
141	Unsupported analog board

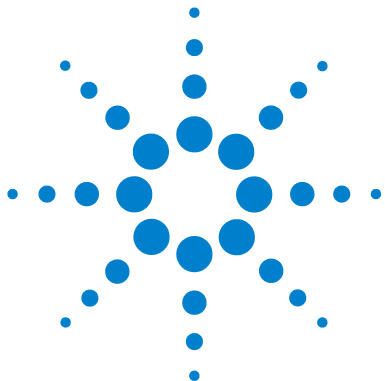

2 Operation and Features

Constant Voltage Operation	38
Constant Current Operation	40
5 V Operation	42
Track Mode Operation	44
Output On/Off Operation	45
Memory Operations	47
Memory Output Operations	49
Programming the Overvoltage Protection	52
Programming the Overcurrent Protection	55
Keylock Operation	58
System-Related Operations	59
Extending the Voltage and Current Range	61

This chapter shows you the operations and features for the U8030A Series triple output DC power supplies.



Constant Voltage Operation

The following steps show you how to perform the constant voltage (CV) operation.

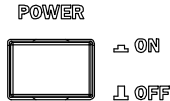

1 Turn on the power supply.

- Press the [**POWER**] button to turn on the power supply.
- The power supply will then perform a self-test (self-test is not indicated at the display).
- The display turns on all annunciators briefly.
- The outputs are disabled by default. The **OFF** annunciator turns on.
- The display shows **OFF** for both outputs (line 1 and 2).

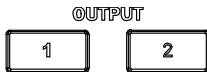

2 Select an output channel.

- Press [**1**] to select Output 1, or
- Press [**2**] to select Output 2.
- The corresponding annunciator (**OUT1** or **OUT2**) turns on.



3 Set the display to the limit mode.

- Press the [**Display Limit**] button to set the display to the limit mode. The **LIMIT** annunciator turns on.
- The display will show the voltage and current limit values for the selected output.
- The display for the non-selected output remains unchanged.

NOTE

When you press the [**Display Limit**] button, the voltage and current limit values will be shown on the display for about five seconds. If there is no activity detected, the display will return to the meter mode.



4 Adjust for the desired output voltage.

- Press the [**Voltage/Current**] button if necessary until the **V** annunciator blinks.
- While the **V** annunciator is blinking, turn the knob to adjust for the desired output voltage value.



5 Adjust for the desired current limit.

- Press the [**Voltage/Current**] button if necessary until the **A** annunciator blinks.
- While the **A** annunciator is blinking, turn the knob to adjust for the desired current limit value.



6 Return to the meter mode.

- Press the [**Display Limit**] button to return to the meter mode.
- The **LIMIT** annunciator turns off.



7 Enable the output.

- Press the [**Output 1 On/Off**] or [**Output 2 On/Off**] button to enable the output.
- The **OFF** annunciator turns off and the **CV** annunciator turns on for the corresponding output.
- The display is now in the meter mode.

NOTE

Verify that the power supply is in the constant voltage mode. Ensure that the constant voltage (CV) annunciator is on. If the constant current (CC) annunciator is on instead, choose a higher current limit.

Constant Current Operation

The following steps show you how to perform the constant current (CC) operation.

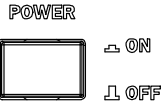

1 Short the binding posts.

- Press the [**POWER**] button to turn off the power supply.
- Connect a short circuit between the positive (+) and negative (–) binding posts of your desired output.

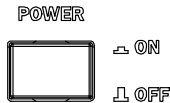

2 Turn on the power supply.

- Press the [**POWER**] button to turn on the power supply.
- The power supply will then perform a self-test (self-test is not indicated at the display).
- The display turns on all annunciators briefly.
- The outputs are disabled by default (the **OFF** annunciator turns on).
- The display shows **OFF** for both outputs (line 1 and 2).

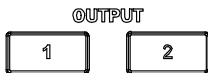

3 Select an output channel.

- Press [**1**] to select Output 1, or
- Press [**2**] to select Output 2.
- The corresponding annunciator (**OUT1** or **OUT2**) turns on.



4 Set the display to the limit mode.

- Press the [**Display Limit**] button to set the display to the limit mode. The **LIMIT** annunciator turns on.
- The display will show the voltage and current limit values for the selected output.
- The display for the non-selected output remains unchanged.

NOTE

When you press the [**Display Limit**] button, the voltage and current limit values will be shown on the display for about five seconds. If there is no activity detected, the display will return to the meter mode.

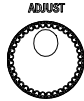

5 Adjust for the desired voltage limit.

- Press the [**Voltage/Current**] button if necessary until the **V** annunciator blinks.
- While the **V** annunciator is blinking, turn the knob to adjust for the desired output voltage value.

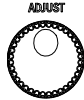

6 Adjust for the desired output current.

- Press the [**Voltage/Current**] button if necessary until the **A** annunciator blinks.
- While the **A** annunciator is blinking, turn the knob to adjust for the desired current limit value.



7 Return to the meter mode.

- Press the [**Display Limit**] button to return to the meter mode.
- The **LIMIT** annunciator turns off.



8 Enable the output.

- Press the [**Output 1 On/Off**] or [**Output 2 On/Off**] button to enable the output.
- The **OFF** annunciator turns off and the **CC** annunciator turns on for the corresponding output.
- The display is now in the meter mode.

NOTE

Verify that the power supply is in the constant current mode. Ensure that the constant current (**CC**) annunciator is on. If the constant voltage (**CV**) annunciator is on instead, choose a higher voltage limit.

5 V Operation

The following steps show you how to output a constant 5 V from the 5 V output channel.

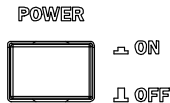

1 Turn on the power supply.

- Press the [**POWER**] button to turn on the power supply.
- The power supply will then perform a self-test (self-test is not indicated at the display).
- The display turns on all annunciators briefly.
- The outputs are disabled by default. The **OFF** annunciator turns on.
- The display shows **OFF** for both outputs (line 1 and 2).



2 Enable the 5 V output.

- Press the [**5 V On/Off**] button to enable the 5 V output.
- The **OFF** annunciator turns off and the **5 V** annunciator turns on.



3 Disable the 5 V output.

- Press the [**5 V On/Off**] button again to disable the 5 V output.
- The **5 V** annunciator turns off.

Overload condition



When an overload condition is detected, the 5 V output will be disabled automatically.

- The **5 V** annunciator turns off.
- The **5VOL** annunciator turns on.
- To clear the overload condition and enable the 5V output in a single step, press the [**5 V On/Off**] button.

Circuit fault condition



When an internal circuit fault is detected, the 5 V output will be disabled automatically.

- The **5 V** annunciator blinks.
- The circuit fault condition might be cleared by cycling the unit power.
- If the fault condition persists, stop using the unit and send it to an authorized service center for repair.

Track Mode Operation

When the track mode is enabled, the voltage settings of Output 1 and Output 2 will mirror each other. The following steps show you how to track the voltage of the selected output.

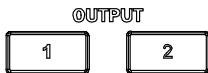

1 Select an output channel.

- Press [1] to select Output 1, or
- Press [2] to select Output 2.
- The corresponding annunciator (**OUT1** or **OUT2**) turns on.

2 Set the desired voltage setting for the selected output channel.

- Repeat [step 3](#) to [step 7](#) from the “Constant Voltage Operation” on page 38.



3 Enable the track mode.

- Press and hold the [Track] button. The display shows **HOLd** until the track mode is enabled.
- The **TRACK** annunciator turns on.
- The voltage setting of the non-selected output is set to the same voltage setting of the selected output.



4 Disable the track mode.

- Press the [Track] button again. The **TRACK** annunciator turns off.
- The track mode is disabled.

Output On/Off Operation

The following steps show you how to turn on all outputs at the same time or to turn on each output individually.

Turn on or off all outputs

When the power supply is turned on, all outputs (Output 1, Output 2, and the 5 V output) are disabled by default.



1 Enable all outputs at the same time.

- Press the [**All On/Off**] button to enable all the outputs in a single button press.
- The **OFF** annunciator turns off.
- The display shows voltage and current values for Output 1 on line 1 and Output 2 on line 2.
- The **5 V** annunciator turns on.



2 Disable all outputs at the same time.

- If any of the outputs are enabled, pressing the [**All On/Off**] button will disable all the outputs.

NOTE

If all the outputs are disabled, pressing the [**All On/Off**] button will enable all the outputs.

Turn on or off individual outputs

Each output can be individually enabled or disabled by pressing its corresponding On/Off button.



1 Enable or disable Output 1.

- Press the [**Output 1 On/Off**] button to enable Output 1.
- The display shows voltage and current values for Output 1 on line 1.
- The display Output 2 on line 2 remains unchanged.
- Press the [**Output 1 On/Off**] button again to disable Output 1.



2 Enable or disable Output 2.

- Press the [**Output 2 On/Off**] button to enable Output 2.
- The display shows voltage and current values for Output 2 on line 2.
- The display Output 1 on line 1 remains unchanged.
- Press the [**Output 2 On/Off**] button again to disable Output 2.



3 Enable or disable the 5 V output.

- Press the [**5 V On/Off**] button to enable the 5 V output.
- The 5 V annunciator turns on.
- The display Output 1 and Output 2 on line 1 and 2 remains unchanged.
- Press the [**5 V On/Off**] button again to disable the 5 V output.

NOTE

The **OFF** annunciator turns on only when all the three outputs are disabled.

Memory Operations

Up to three operating states can be stored in the non-volatile storage locations. The storage feature remembers the voltage and current limit value settings; OVP and OCP on or off states; and OVP and OCP trip levels. The following steps show you how to store and recall an operating state.

Storing an operating state



1 Store the power supply current operating state.

- Press the [**Memory**] button.
- The **M1** annunciator will blink.



2 Turn the knob to choose the memory location for storing the operation state.

- The **M1**, **M2**, and **M3** annunciators will blink in a round-robin manner.



3 Press the [Memory**] button again to save the current operating state in the chosen memory location.**

- The display will show **dOnE**.
- The **M1**, **M2**, and **M3** annunciators turn off.

NOTE

To cancel this operation, allow the unit to idle for five seconds.

Recalling an operating state



1 Recall a previously stored operating state.

- Press and hold the [**Memory**] button until the **M1** annunciator stops blinking.
- The **M1** annunciator turns on.
- The display shows the settings stored in the **M1** memory location.



2 Turn the knob to show the settings saved in M1, M2, and M3 memory locations.

- The **M1**, **M2**, and **M3** annunciators will turn on in a round-robin manner.
- The display shows the settings stored in the **M1**, **M2**, and **M3** memory location in a round-robin manner.



3 Press the [**Memory**] button again to recall the stored operating state in the chosen memory location.

- The display will show **dOnE**.
- The **M1**, **M2**, and **M3** annunciators turn off.

NOTE

To cancel this operation, allow the unit to idle for five seconds.

Memory Output Operations

The Memory Output feature allows operating states from the **M1**, **M2**, and **M3** memory locations to be recalled automatically in sequential order.

Three time intervals are programmable:

- Δt_1 – time delay between recalling **M1** and recalling **M2**.
- Δt_2 – time delay between recalling **M2** and recalling **M3**.
- Δt_3 – time delay between recalling **M3** and recalling **M1**.

Enable the memory output single operation



1 Enable the memory output single operation.

- Press and hold the [**Memory Output**] button. The display shows **HOLd** until the memory output operation is enabled.
- The Δt annunciator turns on, and all the **M1**, **M2**, and **M3** annunciators turn on.
- The operating state from **M1** memory location is recalled immediately.
- The **M1** annunciator blinks. The **M2** and **M3** annunciators are steadily on.
- After waiting for Δt_1 , the operating state from **M2** memory location is recalled.
- The **M2** annunciator blinks. The **M1** and **M3** annunciators are steadily on.
- After waiting for Δt_2 , the operating state from **M3** memory location is recalled.
- The **M3** annunciator blinks for two seconds. The **M1** and **M2** annunciators are steadily on.
- The memory output operation is completed.

- The Δt annunciator turns off, and all the **M1**, **M2**, and **M3** annunciators turn off.

Enable the memory output loop operation



1 Enable the memory output loop operation.

- Press and hold the [**Memory Output**] button until the Δt annunciator starts to blink. (The Δt annunciator turns on first before it starts to blink.)
- All the **M1**, **M2**, and **M3** annunciators turn on.
- The operating state from **M1** memory location is recalled immediately.
- The **M1** annunciator blinks. The **M2** and **M3** annunciators are steadily on.
- After waiting for Δt_1 , the operating state from **M2** memory location is recalled.
- The **M2** annunciator blinks. The **M1** and **M3** annunciators are steadily on.
- After waiting for Δt_2 , the operating state from **M3** memory location is recalled.
- The **M3** annunciator blinks. The **M1** and **M2** annunciators are steadily on.
- After waiting for Δt_3 , the operating state from **M1** memory location is recalled.
- The process is repeated infinitely until canceled.



2 Cancel the memory output loop operation.

- Pressing the [**Memory Output**] button during the memory output loop operation will terminate the operation immediately.
- All outputs will be disabled.
- The **OFF** annunciator turns on.

Program the memory output time interval



1 Edit the memory output time interval.

- Press the [Δt] button.
- The Δt annunciator turns on.
- By default, the **M1** annunciator turns on indicating Δt_1 is being selected for adjustment.
- To select Δt_2 or Δt_3 , press the [**Memory**] button until the corresponding **M2** or **M3** annunciator turns on.
- The display shows the time interval in seconds, with the integral part on line 1 and the fractional part on line 2.
- Press the [Δt] button to change the cursor position. Turn the knob to adjust the value. The time interval can be set with a resolution up to 10 ms.
- You can set the time interval within the range of 0 s to 9999.99 s.
- Press and hold the [Δt] button to save the setting.
- The display shows **dOnE**.

NOTE

To cancel this operation, allow the unit to idle for five seconds.

Programming the Overvoltage Protection

Overvoltage protection guards the load against output voltages reaching values greater than the programmed protection level.

The following steps shows you how to enable and disable the overvoltage protection (OVP), how to set the OVP trip level, and how to clear the overvoltage condition.

Set the OVP trip level and enable the OVP

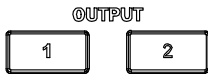

1 Select an output channel.

- Press [1] to select Output 1, or
- Press [2] to select Output 2.
- The corresponding annunciator (**OUT1** or **OUT2**) turns on.



2 Set the OVP trip level.

- Press the [**Over Voltage**] button.
- The **LIMIT** annunciator turns off.
- The corresponding OVP annunciator (**OVP1** or **OVP2**) will blink continuously.
- The display will show the OVP value for the selected output.
- The **V** annunciator will blink continuously.



3 Turn the knob to adjust the OVP value.

- While the **V** annunciator is blinking, turn the knob and adjust to the desired OVP value.



4 Enable the OVP.

- Press the [**Over Voltage**] button again to end the adjustment and enable the OVP.
- The display will show **dOnE**.
- The corresponding OVP annunciator (**OVP1** or **OVP2**) turns on.

NOTE

To cancel this operation, allow the unit to idle for five seconds.

Disable the OVP

OUTPUT



1 Select an output channel with OVP enabled.

- Press [**1**] to select Output 1, or
- Press [**2**] to select Output 2.
- The corresponding annunciator (**OUT1** or **OUT2**) turns on.



2 Disable the OVP.

- Press the [**Over Voltage**] button again to disable the OVP.
- The corresponding OVP annunciator (**OVP1** or **OVP2**) turns off.

Clear the overvoltage condition

The OVP trip can only occur if the corresponding output is enabled. When the OVP trip occurs, the corresponding output is disabled automatically.

- If the OVP trip occurs on Output 1, the display shows **triP** on line 1 and the **OVP1** annunciator blinks.

2 Operation and Features

Programming the Overvoltage Protection

- If the OVP trip occurs on Output 2, the display shows **triP** on line 2 and the **OVP2** annunciator blinks.

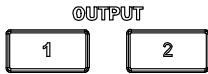

1 Select the output channel with the OVP trip.

- Press [1] to select Output 1, or
- Press [2] to select Output 2.
- The corresponding annunciator (**OUT1** or **OUT2**) turns on.



2 Clear the OVP trip.

- Press the [**Over Voltage**] button again to clear the OVP trip.

NOTE

If the OVP trip persists, decrease the voltage limit settings to clear the tripping.

Programming the Overcurrent Protection

Overcurrent protection guards the load against output currents reaching values greater than the programmed protection level.

The following steps shows you how to enable and disable the overcurrent protection (OCP), how to set the OCP trip level, and how to clear the overcurrent condition.

Set the OCP trip level and enable the OCP

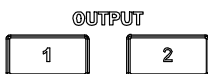

1 Select an output channel.

- Press [1] to select Output 1, or
- Press [2] to select Output 2.
- The corresponding annunciator (**OUT1** or **OUT2**) turns on.



2 Set the OCP trip level.

- Press the [**Over Current**] button.
- The **LIMIT** annunciator turns off.
- The corresponding OCP annunciator (**OCP1** or **OCP2**) will blink continuously.
- The display will show the OCP value for the selected output.
- The **A** annunciator will blink continuously.



3 Turn the knob to adjust the OCP value.

- While the **A** annunciator is blinking, turn the knob and adjust to the desired OCP value.

2 Operation and Features

Programming the Overcurrent Protection



4 Enable the OCP.

- Press the [**Over Current**] button again to end the adjustment and enable the OCP.
- The display will show **dOnE**.
- The corresponding OCP annunciator (**OCP1** or **OCP2**) turns on.

NOTE

To cancel this operation, allow the unit to idle for five seconds.

Disable the OCP

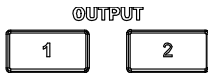

1 Select an output channel with OCP enabled.

- Press [**1**] to select Output 1, or
- Press [**2**] to select Output 2.
- The corresponding annunciator (**OUT1** or **OUT2**) turns on.



2 Disable the OCP.

- Press the [**Over Current**] button again to disable the OCP.
- The corresponding OCP annunciator (**OCP1** or **OCP2**) turns off.

Clear the overcurrent condition

The OCP trip can only occur if the corresponding output is enabled. When the OCP trip occurs, the corresponding output is disabled automatically.

- If the OCP trip occurs on Output 1, the display shows **triP** on line 1 and the **OCP1** annunciator blinks.

- If the OCP trip occurs on Output 2, the display shows **triP** on line 2 and the **OC2** annunciator blinks.

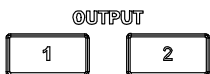

1 Select the output channel with the OCP trip.

- Press [1] to select Output 1, or
- Press [2] to select Output 2.
- The corresponding annunciator (**OUT1** or **OUT2**) turns on.



2 Clear the OCP trip.

- Press the [**Over Current**] button again to clear the OCP trip.

NOTE

If the OCP trip persists, decrease the current limit settings to clear the tripping.

Keylock Operation

This operation provides a locking function for the knob and all the buttons on the front panel of the power supply, which allows you to secure your desired settings.

The keylock is disabled by default upon power-up.



1 Enable the keylock.

- Press the [**Lock/Unlock**] button.
- The **LOCK** annunciator turns on.
- When the keylock function is enabled, the knob and all the buttons are disabled *except* the [**Lock/Unlock**] button.



2 Disable the keylock.

- Press and hold the [**Lock/Unlock**] button for more than one second.
- While the [**Lock/Unlock**] button is being held down, the display will show **HOLD** until the keylock is disabled.
- After the keylock is disabled, the **LOCK** annunciator turns off.

System-Related Operations

Reset to the factory defaults



To reset to factory defaults, press and hold the **[All On/Off]** button when powering on the unit until the display shows **dOnE**.

- The OVP and OCP are disabled, and their trip levels are set to maximum (i.e., 10% above the CV and CC rated values).
- All memory storage locations are cleared.
- The voltage limit value is set to 0, while the current limit value is set to the maximum rated value.
- The calibration data are not affected by the factory default reset.

Power-on self-test

A power-on self-test occurs automatically when the power supply unit is turned on. This test ensures the unit is operational. The power-on self-test checks for flash data memory and checks the voltage and current outputs when the unit is turned off.

NOTE

If the test fails, the display will show **Err** along with the error code. For more information, refer to the “[List of Error Codes](#)” on page 35.

Display the firmware and board versions



To display the firmware and board versions, press and hold the [**Over Voltage**] and [**Display Limit**] buttons simultaneously when powering on the unit.

- The display shows the front panel firmware version on line 1 for one second.
- After that, the display shows:
 - the firmware and board versions of analog board 1 on line 1, and
 - the firmware and board versions of analog board 2 on line 2 for one second.

Extending the Voltage and Current Range

CAUTION

- Never exceed the floating voltage rating of any of the supplies.
 - Never subject any of the power supplies to negative voltages.
-

Two or more power supplies can be connected in series or parallel to extend the range of voltage and current. This may serve as a lower cost alternative to a power supply with higher power rating.

Series connection

Serial connection of two or more power supplies can achieve the output isolation rating of any one supply to obtain a higher voltage than a single power supply. Power supplies connected in series can be operated with one load across both power supplies or with a separate load for each power supply. The power supply has a diode with reverse polarity connected across the output terminals to avoid any damages when operated in series with other power supplies. It will be protected if the load is short-circuited, or when one of the power supply is turned on separately in a series-connected power supplies.

When serial connection is used, the output voltage is the sum of output voltage across all power supplies, while the output current is the output current from an individual power supply. Each power supply must be adjusted to obtain the total output voltage.

2 Operation and Features

Extending the Voltage and Current Range

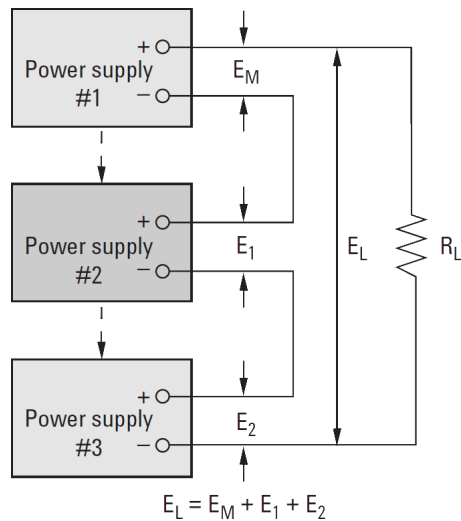

Figure 2-1 Connecting units in series

Parallel connection

Two or more power supplies which are capable of constant voltage or constant current automatic cross-over operation can be connected in parallel to obtain a total output current greater than one power supply. Total output current is the sum of output current across all power supplies. The output settings from each power supply can be made separately.

The control of output voltage for one of the power supply should be set to the desired output value, while the other power supply should be set to a slightly higher output voltage. The power supply with higher output voltage setting will deliver its constant current output and drop its output voltage. This will happen until the output voltage equals the output of the other supply, and the other supply will remain in constant voltage operation; only delivering that fraction of rated output current that is necessary to fulfill the total load demand.

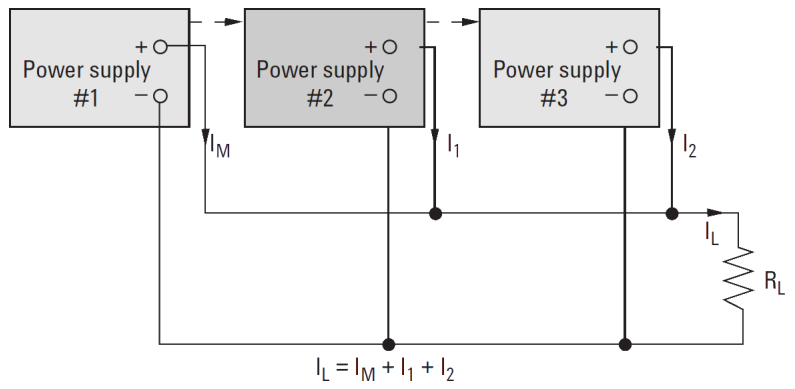

Figure 2-2 Connecting units in parallel

2 Operation and Features

Extending the Voltage and Current Range

THIS PAGE HAS BEEN INTENTIONALLY LEFT BLANK.



3 Characteristics and Specifications

Electrical Specifications	66
Physical Characteristics	67
Supplemental Characteristics	68
Protection Features	69
AC Power Input Specifications	69
Environmental Specifications	70
Connection Specifications	70

This chapter lists the characteristics and specifications of the U8031A and U8032A triple output DC power supplies.



3 Characteristics and Specifications

Electrical Specifications

Electrical Specifications

NOTE

The specifications stated are based on a 1 hour warm-up period.

Table 3-1 Electrical specifications

Parameter	U8031A	U8032A
Total power output (W)	0 W to 375 W	
Voltage output (V) Output Channel 1 & 2 (@ 0 °C to 40 °C)	0 V to 30 V	0 V to 60 V
Current output (A) Output Channel 1 & 2 (@ 0 °C to 40 °C)	0 A to 6 A	0 A to 3 A
Number of outputs	Three isolated output <ul style="list-style-type: none">• Two variable: CV and CC operation• One fixed: CV operation only	
5 V fixed output ^[1] Output Channel 3	<ul style="list-style-type: none">• Voltage/Current output: 5 V, 3A• Output accuracy: $\leq 5\%$ or $(5\text{ V} \pm 0.25\text{ V})$• V_{rms}: $< 2\text{ mV}_{\text{rms}}$, or V_{pp}: $< 50\text{ mV}_{\text{pp}}$• Load and line regulation: $\leq 5\text{ mV}$• Overload condition: 3 A + 20% (typical)	
Note:		
[1] The specifications referenced in this row are for Output Channel 3 (5 V fixed output). All other specifications listed in this table are intended for Output Channel 1 and 2, unless otherwise stated.		
Line and load regulation (for variable output)	<ul style="list-style-type: none">• CV: $< 0.01\% + 2\text{ mV}$• CC: $< 0.02\% + 2\text{ mA}$	
Ripple and noise Based on calculation at temperature of 18 °C to 28 °C and bandwidth at 20 Hz to 20 MHz.	<ul style="list-style-type: none">• CV: $\leq 1\text{ mV}_{\text{rms}}$, $0.5\text{ mV}_{\text{rms}}$ (typical) or $\leq 10\text{ mV}_{\text{pp}}$, 5 mV_{pp} (typical)• CC: $\leq 1\text{ mA}_{\text{rms}}$	
Load transient response time Within 15 mV from full load to half load and from half load to full load.	$< 50\ \mu\text{s}$	

Table 3-1 Electrical specifications (continued)

Parameter	U8031A	U8032A
Stability (output drift) Following a 30-minute warm-up, with the output in the ON state according to the operating mode (CC with load or CV), and with a change in the output over 8 hours under constant load, line, and ambient temperature.	<ul style="list-style-type: none"> • Voltage: <0.02% • Current: <0.1% 	
Programming accuracy (23 °C ± 5 °C)	<ul style="list-style-type: none"> • CV: ≤0.25% + 15 mV • CC: ≤0.30% + 15 mA 	
Meter readback accuracy (23 °C ± 5 °C)	<ul style="list-style-type: none"> • CV: ≤0.25% + 10 mV • CC: ≤0.25% + 10 mA 	
Programming/Meter resolution	<ul style="list-style-type: none"> • Voltage: 10 mV (4 digits) • Current: 10 mA (3 digits) 	
Maximum output float voltage	±240 V _{DC}	

Physical Characteristics

Table 3-2 Physical characteristics

Parameter	U8031A/U8032A
Display	LCD with amber backlight
Rotary knob for reading adjustment	Yes
Size	4U, half rack
Dimensions	179.0 mm × 212.3 mm × 379.0 mm
Weight	8.2 kg

Supplemental Characteristics

Table 3-3 Supplemental characteristics

Parameter		U8031A/U8032A	
Temperature coefficient (for 12 months) ±(% of output + offset)		<ul style="list-style-type: none"> • Output <ul style="list-style-type: none"> • CV: (0.01% + 1 mV) / °C • CC: (0.01% + 1 mA) / °C • OVP, OCP <ul style="list-style-type: none"> • CV: <0.05% / °C • CC: <0.05% / °C 	
Output voltage overshoot During turn-on or turn-off of AC power, if output control is set less than 1 V.		<1 V	
Voltage programming speed, to within 1% of total excursion		30 V	60 V
Up	Full load	80 ms	200 ms
	No load	80 ms	100 ms
Down	Full load	30 ms	30 ms
	No load	150 ms	300 ms
Over-temperature protection		Yes	
Last memory setting enabled		Yes	
Three memory storage locations for voltage and current settings		Yes	
Erasing non-volatile memory		Yes, erasable through the front panel	
Rack mount capability		Yes, front panel and rear have rack-mountable support	

Protection Features

Table 3-4 Protection features

Parameter	U8031A	U8032A
Overvoltage protection accuracy \pm (% of output + offset)	<0.5% +0.5V	
Overvoltage protection programmable range	0.1 V to 33.0 V	0.1 V to 66.0 V
Overvoltage protection response time	<10 ms	
Overcurrent protection accuracy \pm (% of output + offset)	<0.5% + 0.5 A	
Overcurrent protection programmable range	0.1 A to 6.6 A	0.1 A to 3.3 A
Overcurrent protection response time	<10 ms	

AC Power Input Specifications

Table 3-5 AC power input specifications

Parameter	U8031A/U8032A
Input power option (selectable)	<ul style="list-style-type: none"> • 100 V_{ac} \pm 10%, 47 Hz to 63 Hz • 115 V_{ac} \pm 10%, 47 Hz to 63 Hz • 230 V_{ac} \pm 10%, 47 Hz to 63 Hz
Maximum input power	600 VA
Fuse	External, located at the rear panel

3 Characteristics and Specifications

Environmental Specifications

Environmental Specifications

Table 3-6 Environmental specifications

Parameter	U8031A/U8032A
Operating temperature	0 °C to 40 °C
Storage temperature	−40 °C to 70 °C
Humidity	15% RH (relative humidity) to 85% RH at 40 °C (non-condensing)
Altitude	Up to 2000 meters
Fan acoustic noise	<ul style="list-style-type: none">• No load: follow Agilent Class CO, 45 dB sound pressure and 50 dB sound power• Full load: follow Agilent Class GP, 55 dB sound pressure and 60 dB sound power
Environment of use	<ul style="list-style-type: none">• Installation Category II• Pollution Degree 2

Connection Specifications

Table 3-7 Connection specifications

Parameter	U8031A/U8032A
Output connections	+Out, −Out, and chassis ground on the front panel. (Either positive or negative output terminal may be grounded or can be operated floating at up to a maximum of 240 V off ground. Total output voltage to ground must not exceed 240 V _{DC})
Binding posts	Output binding post located horizontally and side by side
I/O connections	N/A
AC input	Three pins standard IEC AC power connector with fuse and line selection at the rear

www.agilent.com

Contact us

To obtain service, warranty, or technical assistance, contact us at the following phone or fax numbers:

United States:

(tel) 800 829 4444 (fax) 800 829 4433

Canada:

(tel) 877 894 4414 (fax) 800 746 4866

China:

(tel) 800 810 0189 (fax) 800 820 2816

Europe:

(tel) 31 20 547 2111

Japan:

(tel) (81) 426 56 7832 (fax) (81) 426 56 7840

Korea:

(tel) (080) 769 0800 (fax) (080) 769 0900

Latin America:

(tel) (305) 269 7500

Taiwan:

(tel) 0800 047 866 (fax) 0800 286 331

Other Asia Pacific Countries:

(tel) (65) 6375 8100 (fax) (65) 6755 0042

Or visit Agilent World Wide Web at:

www.agilent.com/find/assist

Product specifications and descriptions in this document are subject to change without notice. Always refer to the Agilent website for the latest revision.

© Agilent Technologies, Inc., 2011-2012

Third Edition, August 3, 2012
U8031-90004



Agilent Technologies