

**Agilent  
U8001A/U8002A  
Single Output  
DC Power Supplies**

**User's and Service Guide**



**Agilent Technologies**

# Notices

© Agilent Technologies, Inc. 2008–2013

No part of this manual may be reproduced in any form or by any means (including electronic storage and retrieval or translation into a foreign language) without prior agreement and written consent from Agilent Technologies, Inc. as governed by United States and international copyright laws.

## Manual Part Number

U8001-90001

## Edition

Fifth Edition, July 12, 2013

Printed in Malaysia

Agilent Technologies, Inc.  
3501 Stevens Creek Blvd.  
Santa Clara, CA 95052 USA

Microsoft<sup>®</sup> is a U.S. registered trademark of Microsoft Corporation.

## Warranty

**The material contained in this document is provided “as is,” and is subject to being changed, without notice, in future editions. Further, to the maximum extent permitted by applicable law, Agilent disclaims all warranties, either express or implied, with regard to this manual and any information contained herein, including but not limited to the implied warranties of merchantability and fitness for a particular purpose. Agilent shall not be liable for errors or for incidental or consequential damages in connection with the furnishing, use, or performance of this document or of any information contained herein. Should Agilent and the user have a separate written agreement with warranty terms covering the material in this document that conflict with these terms, the warranty terms in the separate agreement shall control.**

## Technology Licenses

The hardware and/or software described in this document are furnished under a license and may be used or copied only in accordance with the terms of such license.

## Restricted Rights Legend

U.S. Government Restricted Rights. Software and technical data rights granted to the federal government include only those rights customarily provided to end user customers. Agilent provides this customary commercial license in Software and technical data pursuant to FAR 12.211 (Technical Data) and 12.212 (Computer Software) and, for the Department of Defense, DFARS 252.227-7015 (Technical Data - Commercial Items) and DFARS 227.7202-3 (Rights in Commercial Computer Software or Computer Software Documentation).

## Safety Notices

### CAUTION

A **CAUTION** notice denotes a hazard. It calls attention to an operating procedure, practice, or the like that, if not correctly performed or adhered to, could result in damage to the product or loss of important data. Do not proceed beyond a **CAUTION** notice until the indicated conditions are fully understood and met.

---

















### WARNING

A **WARNING** notice denotes a hazard. It calls attention to an operating procedure, practice, or the like that, if not correctly performed or adhered to, could result in personal injury or death. Do not proceed beyond a **WARNING** notice until the indicated conditions are fully understood and met.

---

## Safety Symbols

The following symbols on the instrument and in the documentation indicate precautions which must be taken to maintain safe operation of the instrument.

	Direct current		Off (supply)
	Alternating current		On (supply)
	Both direct and alternating current		Equipment protected throughout by double insulation or reinforced insulation.
	Three-phase alternating current		Caution, risk of electric shock.
	Earth (ground) terminal		Caution, risk of danger (refer to this manual for specific Warning or Caution information).
	Protective conductor terminal		Caution, hot surface.
	Frame or chassis terminal		Out position of a bi-stable push control.
	Equipotentiality		In position of a bi-stable push control.

## General Safety Information

The following general safety precautions must be observed during all phases of operation, service and repair of this instrument. Failure to comply with these precautions or specific warnings elsewhere in this manual violates safety standards of design, manufacture and intended use of the instrument. Agilent Technologies assumes no liability for customer's failure to comply with these requirements.

### WARNING

- **Do not use the device if it appears damaged or defective.**
  - **Observe all markings on the device before connecting any wiring to the device.**
  - **Do not operate the device in the presence of flammable gases or fumes.**
  - **Do not install substitute parts or perform any unauthorized modification to the device.**
  - **Use only the power adapter provided by the manufacturer to avoid any unexpected hazards.**
- 

### CAUTION

- Use the device with the cables provided.
  - Repair or service that this not covered in this manual should only be performed by qualified personnels.
-

## Environment Conditions

This instrument is designed *for indoor use in an installation category II, pollution degree 2 area*. Table 1 shows general environment requirements.

**Table 1** Environment Requirements





Environment Conditions	Requirements
Operating Temperature	0 °C to 40 °C (for full rated output) 40 °C to 55 °C (for derated output)
Operating Relative Humidity (max)	Up to 95%
Storage Temperature	–20 °C to 70 °C
Altitude	Up to 2000 m

### CAUTION

The Agilent U8001A/U8002A single output DC power supplies comply with the following safety and EMC requirements:

- IEC 61326:2002 / EN 61326:1997+A1:1998+A3:2003
- CISPR 11:1990 / EN 55011:1990
- Canada: ICES-001:2004
- Australia / New Zealand: AS/NZS CISPR11:2004
- IEC 61010-1:2001 / EN 61010-1:2001 (2<sup>nd</sup> Edition)
- Canada: CAN/CSA-C22.2 No. 61010-1-04
- USA: ANSI/UL 61010-1:2004

## Regulatory Markings

 <b>ISM 1-A</b>	<p>The CE mark is a registered trademark of the European Community. This CE mark shows that the product complies with all the relevant European Legal Directives.</p>
<b>ICES/NMB-001</b>	<p>ICES/NMB-001 indicates that this ISM device complies with Canadian ICES-001.</p>
 <b>C US</b>	<p>The CSA mark is a registered trademark of the Canadian Standards Association. A CSA mark indicates that the product is certified for Canadian markets, to the applicable Canadian standards.</p>
 <b>N10149</b>	<p>The C-tick mark is a registered trademark of the Spectrum Management Agency of Australia. This signifies compliance with the Australia EMC Framework regulations under the terms of the Radio Communication Act of 1992.</p>
	<p>This instrument complies with the WEEE Directive (2002/96/EC) marking requirement. This affixed product label indicates that you must not discard this electrical/electronic product in domestic household waste.</p>

## Waste Electrical and Electronic Equipment (WEEE) Directive 2002/96/EC

This instrument complies with the WEEE Directive (2002/96/EC) marking requirement. This affixed product label indicates that you must not discard this electrical/electronic product in domestic household waste.

Product Category:

With reference to the equipment types in the WEEE directive Annex 1, this instrument is classified as a "Monitoring and Control Instrument" product.

The affixed product label is shown as below:

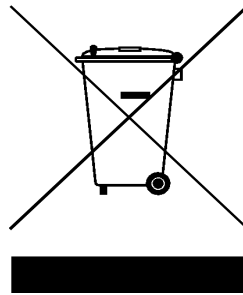

### **Do not dispose in domestic household waste**

To return this unwanted instrument, contact your nearest Agilent office, or visit:

[www.agilent.com/environment/product](http://www.agilent.com/environment/product)

for more information.

## Declaration of Conformity (DoC)

The Declaration of Conformity (DoC) for this instrument is available on the Web site. You can search the DoC by its product model or description.

<http://regulations.corporate.agilent.com/DoC/search.htm>

### NOTE

If you are unable to search for the respective DoC, please contact your local Agilent representative.

---



## In This Guide...

This guide provides step-by-step set up and configuration instructions that get you familiarized with the operations of the Agilent U8001A/U8002A single output DC power supplies. This guide also contains service information and troubleshooting guidelines that help to resolve your problems during startup configurations.

### **1 Quick Start**

Chapter 1 provides preliminary checkout, output checkout, line voltage conversion, and instruction to rack-mount for the U8001A/U8002A single output DC power supplies.

### **2 General Information**

Chapter 2 provides general description of the instrument, front and rear panel overview, display annunciators, and installation guidelines for the U8001A/U8002A single output DC power supplies.

### **3 Operations and Features**

Chapter 3 provides detailed description of the operations and features for the U8001A/U8002A single output DC power supplies.

### **4 Specifications and Characteristics**

Chapter 4 lists the power supply's performance specifications and the supplemental characteristics of the equipment.

### **5 Service Guide**

Chapter 5 contains service information for the U8001A/U8002A single output DC power supplies, including warranty information, general disassemble, verification steps to troubleshoot the connectivity and functionality, detailed

calibration procedures for your power supply, related documentation, and Agilent contacts.

# Contents

## Chapter 1 Quick Start

- Preliminary Checkout 18
- Output Checkout 19
  - Voltage Output Checkout 19
  - Current Output Checkout 20
- If the Power Supply Does Not Turn On 21
- To Rack-mount the Instrument 22

## Chapter 2 General Information

- Front Panel at a Glance 24
- Rear Panel at a Glance 25
- Display Annunciators 26
- Description 27
- Installation 29
  - Initial inspection 29
  - Cooling and location 30
- Output Connections 31
  - Voltage drops 31

## Chapter 3 Operations and Features

- Constant Voltage Operation 34
- Constant Current Operation 36
- Memory Operations 38
  - Storing Operating State 38

## Contents

Recalling Operating State	39
Programming Over Voltage Protection	40
Programming Over Current Protection	42
Keylock Operation	44
Backlight Operation	45
System Related Operations	46
Reset to factory defaults	46
Power-on self-test	46
Extending the Voltage and Current Range	47
Series connection	47
Parallel connection	47
<b>Chapter 4</b> Specifications and Characteristics	
Performance Specifications	50
Supplemental Characteristics	51
<b>Chapter 5</b> Service Guide	
Equipment Warranty	56
Replacement Parts	58
Troubleshooting	59
Line Voltage Conversion	60
Performance Verification and Calibration	63
Constant Current (CC) Verification	76
Voltage Calibration	82
Current Calibration	84
<b>Appendix</b>	
Appendix A: List of Error Codes	58



## Contents



# 1 Quick Start

Preliminary Checkout [18](#)  
Output Checkout [19](#)  
If the Power Supply Does Not Turn On [21](#)  
To Rack-mount the Instrument [22](#)

This chapter is intended for both the experienced and inexperienced users because it calls attention to certain checks that should be made prior to operation.



## Preliminary Checkout

The following steps help you to validate that the power supply is ready for use.

### 1 Check the list of supplied item.

Verify that you have received the following items together with your power supply. If anything is found missing, contact your nearest Agilent Technologies Sales Office.

- Power cord
- Certificate of Calibration
- Product Reference CD-ROM

### 2 Connect the power cord and turn on the power supply.

The front-panel display will light up while the power supply performs its power-on self-test. The firmware revision is also displayed. If the power supply does not turn on properly, see [page 21](#).

#### NOTE

The power supply is shipped from the factory with a power-line cord that has a plug appropriate for your location. Your power supply is equipped with a 3-wire grounding type power cord; the third conductor being the ground. The power supply is grounded only when the power-line cord is plugged into an appropriate receptacle. Do not operate your power supply without adequate cabinet ground connection.

---



## Output Checkout

The following procedures check to ensure that the power supply develops its rated outputs and properly responds to operation from the front panel. For complete performance and verification tests, refer to the “[Service Guide](#)”.

### NOTE

If an error has been detected during the output checkout procedures, the **ERROR** annunciator will be turned on. See “[Appendix A: List of Error Codes](#)” for more information.

---

## Voltage Output Checkout

The following steps verify basic voltage functions with no load.

- 1 Turn on the power supply.

The power supply is in a power-on / reset state; the output is disabled (the OFF annunciator turns on).

- 2 Enable the outputs.

The OFF annunciator turns off. Notice that the display is in the meter mode. "Meter mode" means that the display shows the output voltage and current limit.

- 3 Check that the front-panel voltmeter properly responds to knob control.
- 4 Turn the knob clockwise or counter clockwise to check that the voltmeter responds to knob control and the ammeter indicates nearly zero.
- 5 Ensure that the voltage can be adjusted from zero to the full rated value by adjusting the knob.

### NOTE

When the power supply is turned on, the last memory will be shown on the display.

---

## Current Output Checkout

The following steps check basic current functions with a short across the power supply's output.

- 1 Turn on the power supply.

Make sure that the output is disabled. The OFF annunciator is on.

- 2 Connect a short across (+) and (-) output terminals with an insulated test lead. Use a wire size sufficient to handle the maximum current (refer to the American Wire Gauge standard).

- 3 Enable the output.

The CV or CC annunciator turns on depending on the resistance of the test lead. Notice that the display is in the meter mode.

- 4 Adjust the voltage limit value to 1.0 volt.

Set the display to the limit mode. Adjust the voltage limit to 1.0 V to assure CC operation. The CC annunciator will be turned on. To go back to normal mode, press the key again or let the display time out after several seconds.

- 5 Set the knob to the current control to check that the front-panel ammeter properly responds to knob control.

Turn the knob clockwise or counter clockwise when the display is in the meter mode (the Limit annunciator is off). Check that the ammeter responds to knob control and the voltmeter indicates nearly zero (the voltmeter will show the voltage drop caused by the test lead).

- 6 Ensure that the current can be adjusted from zero to the full rated value.

- 7 Turn off the power supply and remove the short from the output terminals.

## If the Power Supply Does Not Turn On

Use the following steps to help solve problems you might encounter when turning on the instrument. If you need more help, refer to [Chapter 5](#) for instructions on returning the instrument to Agilent Technologies for service.

### 1 Verify that there is ac power to the power supply.

First, verify that the power cord is firmly plugged into the power receptacle on the rear panel of the power supply. You should also make sure that the power source you plugged the power supply into is energized. Then, verify that the power supply is turned on.

### 2 Verify the power-line voltage setting.

The line voltage is set to the proper value for your country when the power supply is shipped from the factory. Change the voltage setting if it's not correct. The settings are: 100, 115, or 230 Vac.

### 3 Verify that the correct power-line fuse is installed.

The correct fuse is installed for your country when the power supply is shipped from the factory. See the table below to replace the fuse for your power supply.

Model	Agilent Part Number	Part Description
U8001A	2110-0014	Fuse 4.0 A T for 100 and 115 Vac
	2110-0006	Fuse 2.0 A T for 230 Vac
U8002A	2110-0722	Fuse 6.25 A T for 100 and 115 Vac
	2110-1425	Fuse 2.8 A T for 230 Vac

**Figure 1-1** List of Rated Fuse for Line Voltages

## To Rack-mount the Instrument

You can mount the power supply in a standard 19-inch rack cabinet using one of three optional kits available. Instructions and mounting hardware are included with each rack-mounting kit.

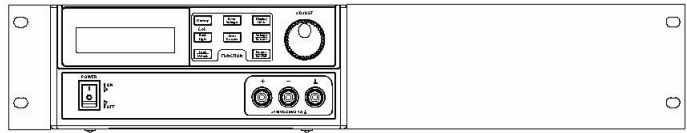

To rack-mount a single instrument, order adapter kit 5063-9240.

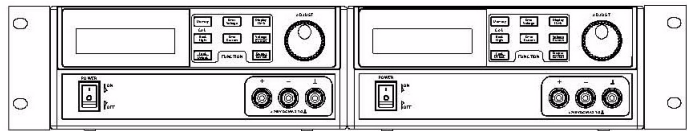

To rack-mount two instruments side-by-side, order lock-link kit, 5061-9694 and flange kit, 5063-9212. Be sure to use the support rails inside the rack cabinet.

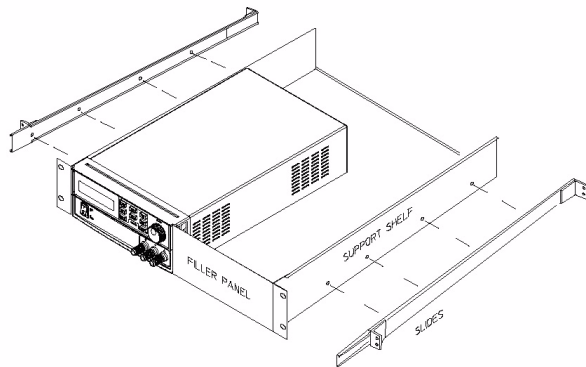

To install two instruments in a sliding support shelf, order support shelf, 5063-9255, and slide kit, 1494-0015.

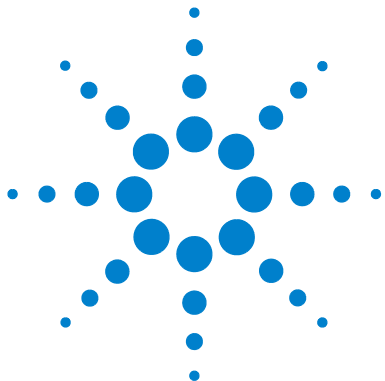

## 2 General Information

Front Panel at a Glance	24
Rear Panel at a Glance	25
Display Annunciators	26
Description	27
Installation	29
Output Connections	31

This chapter provides general description of the instrument, front panel overview, rear panel overview, display annunciators and installation guidelines for U8001A/U8002A single output DC power supplies.



## Front Panel at a Glance

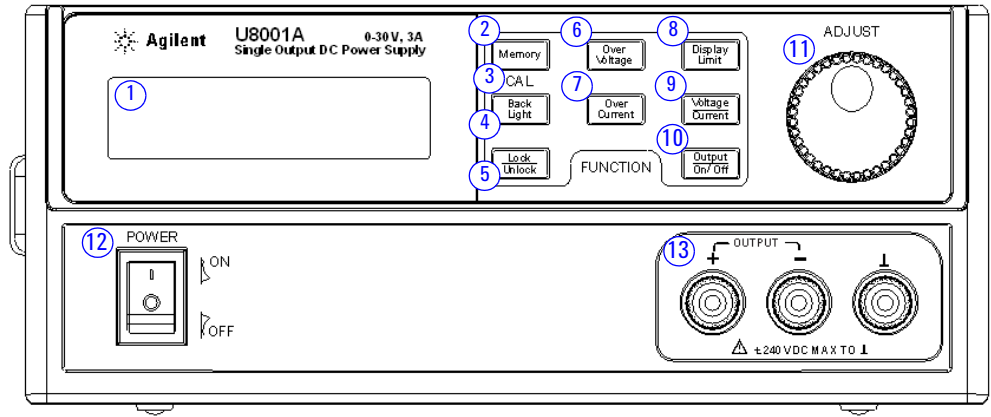

	Panels	Functions
1	LCD Display	Displays the measurements.
2	Memory	To set the memory settings, enables memory recall and memory state selection (M1, M2, M3).
3	CAL	Enables voltage and current calibration.
4	Back Light	To turn On/Off the backlight.
5	Lock / Unlock	Enables and disables the front panel operation.
6	Over Voltage	Enables and disables the over voltage protection function, sets trip voltage and clears the over voltage condition.
7	Over Current	Enables and disables the over current protection function, sets trip current and clears the over current condition.
8	Display Limit	Displays and sets the voltage and current limit values.
9	Voltage / Current	Selects the knob control function for voltage and current adjustment.
10	Output On/Off	Enables and disables the power supply output.
11	Knob	Increases and decreases the value of the flashing digit.
12	Power On/Off	To turn On/Off the power supply.
13	Binding posts	Positive, negative and ground binding posts for wire connections.

## Rear Panel at a Glance

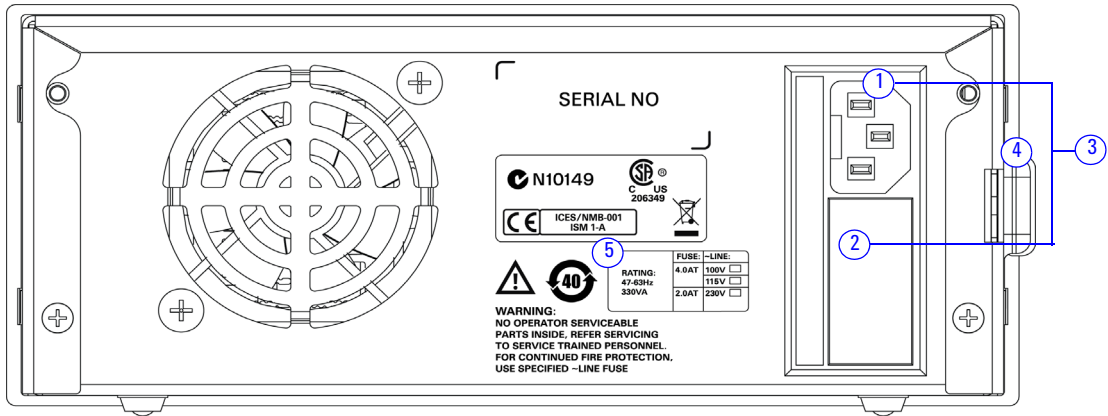

	Panels	Functions
1	AC inlet	Connects AC power line.
2	Power fuse-holder assembly	Sets the line voltage to the proper values for different country based.
3	Power-line module	Combination of the AC inlet and power fuse-holder assembly.
4	Physical lock mechanism	Enables physical lock mechanism.
5	Line Voltage Fuse Rating indicator	Indicates the line voltage and line fuse rating.

## Display Annunciators

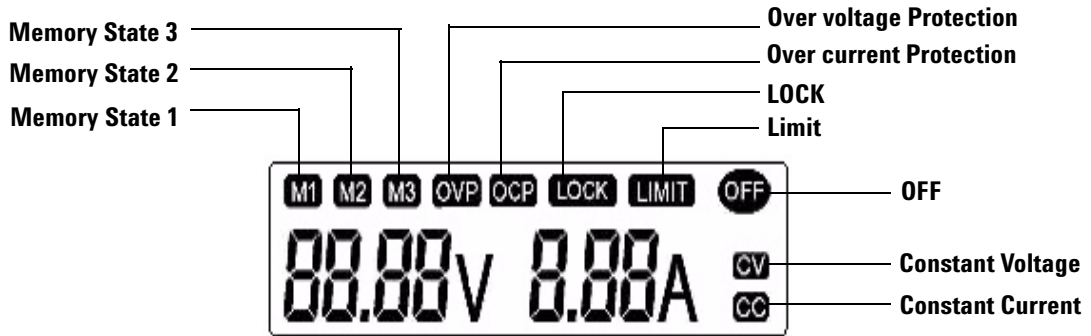

Annunciators	Functions
<b>M1</b> <b>M2</b> <b>M3</b>	Stores states of power supply in non-volatile memory When the power supply is in calibration mode, it can be used to store calibration constant.
<b>OVP</b>	The over voltage protection function is enabled when the annunciator turns on or the over voltage protection circuit has caused the power supply to shutdown when the annunciator blinks.
<b>OCP</b>	The over current protection function is enabled when the annunciator turns on or the over current protection circuit has caused the power supply to shutdown when the annunciator blinks.
<b>LOCK</b>	The front panel operation is disabled
<b>LIMIT</b>	The display shows the limit values of voltage and current.
<b>OFF</b>	The output of the power supply is disabled.
<b>CV</b>	The power supply is in constant voltage mode when the annunciator blinks.
<b>CC</b>	The power supply is in constant current mode when the annunciator blinks



## Description

The Agilent U8001A/U8002A single output DC power supplies are compact, general purpose bench supplies that are suitable for either bench or rack-mounted operations. These power supplies feature linear power supply performance and capable usabilities, making them ideal for power systems applications.

Operational features include:

- Single-output
- Constant voltage (CV) or constant current (CC) operation
- Over voltage protection (OVP) and Over current protection (OCP)
- Three storage locations (M1 to M3) for user-defined operating states
- Keypad lock capability
- Physical lock mechanism

The front panel operation permits:

- Easy-to-use control features
- Enabling or disabling OVP and OCP
- Setting the OVP and OCP trip levels
- Clearing OVP and OCP conditions
- Setting and displaying the voltage and current limit values
- Operating state storage/recall
- Resetting the power supply to power-on state
- Calibrating the power supply
- Enabling or disabling the output

The front-panel liquid crystal display (LCD) includes:

- Displaying actual values of output voltage and current (meter mode)
- Or displaying the limit values of voltage and current (limit mode)
- Checking the operating status from the annunciators

**Front panel binding posts** are available to connect load wires for *bench* operation.

### **WARNING**

**Floating the power supply output more than  $\pm 240$  Vdc from the chassis presents an electric shock hazard to the operator.**

---

# Installation

## Initial inspection

When you receive your power supply, inspect it for any obvious damage that may have occurred during shipment. If any damage is found, notify the carrier and the nearest Agilent Technologies Sales Office immediately. Warranty information is shown in the front of this manual.

Keep the original packing materials in case the power supply has to be returned to Agilent Technologies in the future. If you return the power supply for service, attach a tag identifying the owner and model number. Also include a brief description of the problem.

### Mechanical Check

This check confirms that there are no broken terminals or knob and that the cabinet and panel surfaces are free of dents and scratches. Verify that the display is not scratched or cracked.

### Electrical Check

Chapter 1 describes quick operation procedure that verifies to a high level of confidence that the power supply is operating in accordance with its specifications. More complete verification procedures are included in the “[Service Guide](#)” on page 55.

## Cooling and location

### Cooling

The power supply can operate at rated specifications within the temperature range of 0 °C to 40 °C. Power supply loading is derated from 40 °C to 55 °C. A fan cools the power supply by drawing air through the sides and exhausting it out the back. Using an Agilent rack-mount will not impede the flow of air.

### Bench Operation

Your power supply must be installed in a location that allows sufficient space at the sides and rear of the power supply for adequate air circulation.

### Cleaning

No cleaning is required for this product. If you wish to remove dust from the enclosure, use a dry cloth.

## Output Connections

**WARNING**

Before attempting to connect wires to the front output terminals, make sure to turn off the power supply first to avoid damage to the circuits being connected.

---

### Voltage drops

The load wires must be large enough to avoid excessive voltage drops due to the impedance of the wires. In general, if the wires are heavy enough to carry the maximum short circuit current without overheating, excessive voltage drops will not be a problem. The voltage drops across the load wires should be limited to less than 2 V. Refer to the American Wire Gauge (AWG) standard to calculate the voltage drop for some commonly used AWG wire copper.

## **2 General Information**



## 3 Operations and Features

Constant Voltage Operation	34
Constant Current Operation	36
Memory Operations	38
Programming Over Voltage Protection	40
Programming Over Current Protection	42
Keylock Operation	44
Backlight Operation	45
System Related Operations	46
Extending the Voltage and Current Range	47

You have now learned how to install the power supply. You were also briefly introduced to the front panel keys and their functionality from previous chapter. This chapter shows you the operations and features for the U8001A/U8002A single output DC power supplies.



## Constant Voltage Operation

The following steps show you how to perform the constant voltage (CV) operation.

### 1 Turn on the power supply.



- Press on the “Power” button to turn on the power supply. The power supply will then perform a self-test (Self-test is not indicated at display).
- The display turns on all segments and shows the firmware version briefly after that.
- The output is disabled by default.
- The OFF annunciator turns on.
- The display shows “OFF”

### 2 Set the display to the limit mode.



- Press on the “Display Limit” button in order to turn on the LIMIT annunciator.
- The display will show the voltage and current limit values.

#### NOTE

When you press on the Display Limit button, the voltage and current limit values will be shown on the display for about five seconds. If there is no activity detected, the display will return to meter view mode.



### 3 Adjust for the desired output voltage.

- Press on the “Voltage/Current” button. When seeing the voltage value, “V” blinks, turn the knob to adjust for the desired output voltage value.





#### 4 Adjust for the desired current limit.

- Press on the “Voltage/Current” button. When seeing the current value, “A” blinks, turn the knob to adjust for the desired current limit value.



#### 5 Return to the meter mode.

- Press on the “Display Limit” button to return to the meter mode. The LIMIT annunciator will be turned off.



#### 6 Enable the output.

- Press on the “Output On/Off” button to enable the output.
- The OFF annunciator turns off and CV annunciator turns on.
- The display is now in meter mode.

### NOTE

Verify that the power supply is in constant voltage mode. Ensure that the constant voltage (CV) annunciator is on. If the constant current (CC) annunciator is on instead, choose a higher current limit.

## Constant Current Operation

The following steps show you how to perform the constant current operation.

### 1 Short the binding posts.



- Press on the “Power” button to turn off the power supply.
- Connect a short circuit between the positive (+) and negative (–) binding posts.

### 2 Turn on the power supply.



- Press on the “Power” button to turn on the power supply. The power supply will then perform a self-test.
- The display turns on all segments and shows the firmware version briefly after that.
- The output is disabled by default.
- The OFF annunciator turns on.

### 3 Set the display to the limit mode.



- Press on the “Display Limit” button in order to turn on the LIMIT annunciator.
- The display will show the voltage and current limit values.

## NOTE

When you press on the Display Limit button, the voltage and current limit values will be shown on the display for about five seconds. If there is no activity detected, the display will return to meter view mode.



### 4 Adjust for the desired voltage limit.

- Press on the “Voltage/Current” button. When seeing the voltage value, “V” blinks, turn the knob to adjust for the desired voltage limit value.



### 5 Adjust for the desired output current.

- Press on the “Voltage/Current” button. When seeing the current value, “A” blinks, turn the knob to adjust for the desired output current value.



### 6 Return to the meter mode.

- Press on the “Display Limit” button to return to the meter mode. The LIMIT annunciator will be turned off.



### 7 Enable the output.

- Press on the “Output On/Off” button to enable the output.
- The OFF annunciator turns off and constant current (CC) annunciator turns on.
- The display is now in meter mode.

## NOTE

Verify that the power supply is in constant current mode. Ensure that the constant current (CC) annunciator is on. If the constant voltage (CV) annunciator is on instead, choose a higher voltage limit.

## Memory Operations

For Agilent U8001A/U8002A single output DC power supplies, up to three operating states can be stored in non-volatile storage locations. The storage feature *remembers* the voltage and current limit value settings, OVP\*/OCP† On/Off states, and OVP/OCP trip levels. The following steps show you how to store and recall an operating state.

### Storing Operating State

**1 Press on the “Memory” button.**



- The M1 annunciator will blink.

**2 Turn the knob to choose the memory location for storing the operation state.**



- The M1, M2 and M3 annunciators will blink in a round-robin manner.

**3 Press on the “Memory” button again to save the operating state in the chosen memory.**



- Display will show “donE”.
- The M1, M2 and M3 annunciators will be turned off.

**NOTE**

To cancel the operation, allow the unit to idle for five seconds.

\* OVP- over voltage protection

† OCP- over current protection



### Recalling Operating State

**1 Press and hold the “Memory” button.**

- The M1 annunciator will be turned on.
- The LIMIT annunciator will be turned off.
- The display shows the settings saved in M1 memory location.



**2 Turn the knob to show the settings saved in M1, M2 and M3 memory locations.**

- The M1, M2 and M3 annunciators will be turned on in round-robin manner.



**3 Press on the “Memory” button if you want to use the shown settings as the current operating settings**

- The M1, M2 and M3 annunciators will be turned off.

#### NOTE

To cancel the operation, allow the unit to idle for five seconds.

## Programming Over Voltage Protection

Over voltage protection guards the load against output voltages reaching values greater than the programmed protection level.

The following steps show how to enable and disable the over voltage protection (OVP), how to set the OVP trip level and how to clear the over voltage condition.

### To set the OVP trip level and enable OVP



#### 1 Press on the “Over Voltage” button.

- The LIMIT annunciator will be turned off.
- The OVP annunciator will fast-blink continuously.
- The display will show the OVP value and the character “V” will fast-blink continuously.



#### 2 Turn the knob to adjust the OVP value.



#### 3 Press on the “Over Voltage” button again to end the adjustment and enable the OVP.

- Display will show “donE”.
- The OVP annunciator will be turned on.

### NOTE

To cancel the operation, allow the unit to idle for five seconds.

**To disable OVP**

- 1 Press on the “Over Voltage” button to disable the OVP. The OVP annunciator will eventually turn off.

**To clear the over voltage condition**

- 1 OVP trip can only occur when the output is enabled. When the OVP condition occurs:
  - The output is disabled and the OFF annunciator will be turned on.
  - If the keylock feature was enabled, it will be disabled. The LOCK annunciator will be turned off.
  - The OVP annunciator will fast-blink continuously.
  - The display will show “TRIP”.



- 2 To clear the OVP trip condition, press on the “Over Voltage” button again.

**NOTE**

If OVP trip persists, decrease the voltage limit settings to clear the tripping.

---

## Programming Over Current Protection

Over current protection guards the load against output currents reaching values greater than the programmed protection level.

The following steps show how to enable and disable the over current protection (OCP), how to set the OCP trip level and how to clear the over voltage condition.

### To set the OCP trip level and enable OCP



#### 1 Press on the “Over Current” button.

- The LIMIT annunciator will be turned off.
- The OCP annunciator will fast-blink continuously.
- The display will show the OCP value and the character “A” will fast-blink continuously.



#### 2 Turn the knob to adjust the OCP value.



#### 3 Press on the “Over Current” button again to end the adjustment and enable the OCP.

- Display will show “donE”.
- The OCP annunciator will be turned on.

### NOTE

To cancel the operation, allow the unit to idle for five seconds.





### To disable the OCP

- 1 Press on the “Over Current” button to disable the OCP. The OCP annunciator will eventually turn off.

### To clear the over current condition

- 1 OCP trip can only occur when the output is enabled. When the OCP condition occurs:
  - The output is disabled and the OFF annunciator will be turned on.
  - If the keylock feature was enabled, it will be disabled. The LOCK annunciator will be turned off.
  - The OCP annunciator will fast-blink continuously.
  - The display will show “TRIP”.
- 2 To clear the OCP trip condition, press on the “Over Current” button again.



### NOTE

If OCP trip persists, decrease the current limit settings to clear the tripping.

## Keylock Operation

This operation provides locking function for the knob and all the buttons on front panel of the equipment which allows end users to secure their desired settings.

The keylock is disabled by default when power-up.

### To enable keylock



- 1 Press on the “Lock/Unlock” button. The LOCK annunciator will be turned on.
- 2 When the keylock function is enabled, the knob and all the buttons are disabled EXCEPT “Lock/Unlock” button.

### To disable keylock



- 1 Press and hold down the “Lock/Unlock” button for three seconds.
- 2 When the “Lock/Unlock” button is being held down, the display will show “HOLD” until the keylock is disabled.
- 3 After the keylock is disabled, the LOCK annunciator will be turned off .

## Backlight Operation

This operation provides the backlight for the LCD display. The backlight will be enabled by default when power-up.

### To turn on the backlight



- 1 Press on the “Back Light” button. The backlight will be turned on.

### To turn off the backlight



- 1 Press on the “Back Light” button. The backlight will be turned off.

## System Related Operations



### Reset to factory defaults

To reset the power supply unit to factory defaults, press and hold “Output On/Off” button when power-up.

- The OVP and OCP are turned off and their values are set to maximum.
- The memory storage locations are cleared
- The voltage and current limit values are set to zero.
- The calibration values are intact.

### Power-on self-test

A power-on self-test occurs automatically when the power supply unit is turned on. This test ensures the unit is operational. The power-on self-test checks for flash data memory and checks the voltage and current outputs when the unit is off.

#### NOTE

If the test fails, the display will show “Err” with the error code. See [“Appendix A: List of Error Codes”](#) for more information.

## Extending the Voltage and Current Range

Two or more power supplies can be connected in series or parallel to extend the range of voltage and current. This may serve as a lower cost alternative to a power supply with higher power rating.

### Series connection

Serial connection of two or more power supplies can achieve the output isolation rating of any one supply to obtain a higher voltage than a single power supply. Power supplies connected in series can be operated with one load across both power supplies or with a separate load for each power supply. The power supply has a diode with reverse polarity connected across the output terminals to avoid any damages when operated in series with other power supplies. It will be protected if the load is short-circuited, or when one of the power supply is turned on separately in a series-connected power supplies.

When serial connection is used, the output voltage is the sum of output voltage across all power supplies, while the output current is the output current from an individual power supply. Each power supply must be adjusted to obtain the total output voltage.

### Parallel connection

Two or more power supplies which are capable of constant voltage or constant current automatic cross-over operation can be connected in parallel to obtain a total output current greater than one power supply. Total output current is the sum of output current across all power supplies. The output settings from each power supply can be made separately. The control of output voltage for one of the power supply should be set to the desired output value, while the other

power supply should be set to a slightly higher output voltage. The power supply with higher output voltage setting will deliver its constant current output and drop its output voltage. This will happen until the output voltage equals the output of the other supply, and the other supply will remain in constant voltage operation; only delivering that fraction of rated output current that is necessary to fulfill the total load demand.



## 4 Specifications and Characteristics

Performance Specifications 50

Supplemental Characteristics 51

This chapter lists the power supply's performance specifications and the supplemental characteristics of the equipment.



## Performance Specifications

**Table 4-1** Electrical Specifications

Parameter	U8001A	U8002A
Output Ratings (at 0 °C to 40 °C)	0 to +30 V 0 to 3 A	0 to +30 V 0 to 5 A
Line and Load Regulation	CV: <0.01% +2 mV CC: <0.02% +2 mA	
Ripple and Noise (25 °C ±5 °C)	CV: 12 mVp-p, <1 mVrms; CC: 3 mArms	
Load Transient Response Time (within 15 mV from full load to half load and from half load to full load)	<50 μs	
Programming Accuracy* (25 °C ±5 °C)	<0.35% +20 mV <0.35% +20 mA	
Readback Accuracy* (25 °C ±5 °C)	<0.35% +20 mV <0.35% +20 mA	
Meter Resolution	Voltage: 10 mV Current: 10 mA	
Maximum Output Float Voltage	±240 Vdc	

\* Specifications are based on 1-hour warm-up period.



## Supplemental Characteristics

**Table 4-2** Supplemental Characteristics

Parameter	U8001A	U8002A
Temperature Coefficient (for 12 months)	CV: <100 ppm/ °C	
	CC: <380 ppm/ °C	CC: <300 ppm/ °C
Output Voltage Overshoot (during turn- on or turn- off AC power state with the output control set to less than 1 V)	<1 V	
Voltage Programming Speed, to within 1% of total excursion		
Up	Full Load	150 ms
	No Load	100 ms
Down	Full Load	30 ms
	No Load	450 ms
Last Memory Setting Enabled	Yes	
Over Voltage Protection Response Time	<1.5 ms when the trip voltage is equal or greater than 3 V and <10 ms when the trip voltage is less than 3 V (average time for output to drop from 90% of output voltage to 1 V after OVP condition occurred)	

**Table 4-3** Protection Features

Parameter	U8001A	U8002A
Over Voltage Protection Accuracy ± (% of output + offset)	<0.5% +0.5 V	
Over Voltage Protection Programmable Range	1 V to 33 V	
Over Current Protection Accuracy ± (% of output + offset)	<0.5% +0.5 A	
Over Current Protection Programmable Range	1 A to 3.3 A	1 A to 5.5 A

## 4 Specifications and Characteristics

**Table 4-4** AC Power Input Specifications

Parameter	U8001A	U8002A
Input Power Option (Selectable)	100 Vac $\pm$ 10%, 47 to 63 Hz 115 Vac $\pm$ 10%, 47 to 63 Hz 230 Vac $\pm$ 10%, 47 to 63 Hz	
Maximum Input Power	330 VA	500 VA
Fuse	External, customer assessable	

**Table 4-5** Physical Specifications

Parameter	U8001A	U8002A
Dimension (H x W x L)	88.1 mm x 212.3 mm x 361.8 mm	
Weight (kg)	7.3 kg	8.3 kg

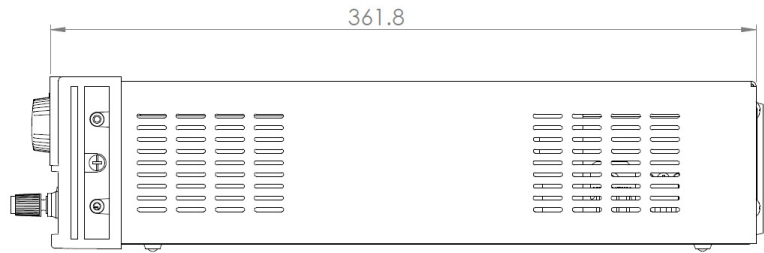

Figure 4-1 Physical dimensions of unit – length

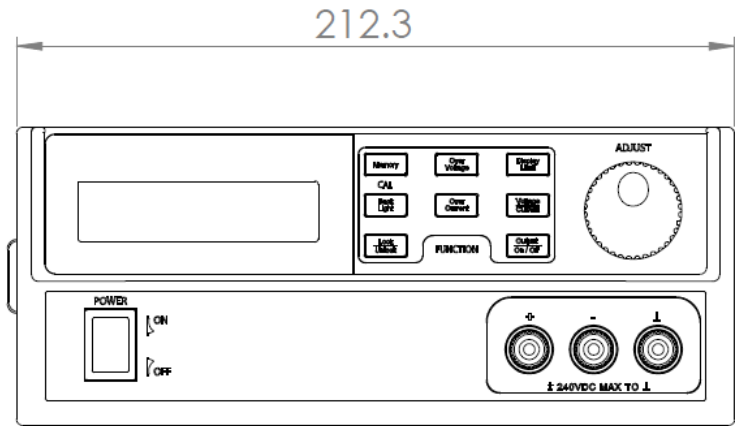
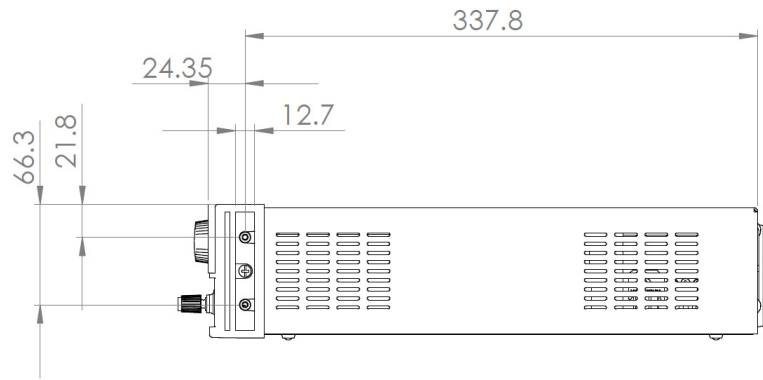
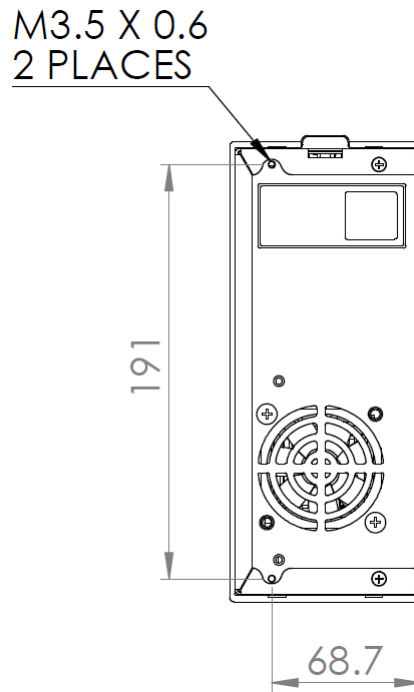

Figure 4-2 Physical dimensions of unit – width

## 4 Specifications and Characteristics



**Figure 4-3** Physical dimensions of unit – miscellaneous dimensions



**Figure 4-4** Physical dimensions of unit – height



## 5 Service Guide

Equipment Warranty	56
Replacement Parts	58
Troubleshooting	59
Performance Verification and Calibration	63
Voltage Calibration	82
Current Calibration	84

This chapter contains service information for the U8001A/U8002A single output DC power supplies, including warranty information, general disassemble, verification steps to troubleshoot the connectivity and functionality, detailed calibration procedures for your power supply, related documentation and Agilent contacts.

It is advised that you perform the calibration test before you start using the power supply. The step-by-step calibration procedures are simple and easy to understand. It is meant for both experienced and new users.



## Equipment Warranty

### Types of Service Available

If your instrument fails during the warranty period, Agilent Technologies will replace it under the terms of your warranty. After your warranty expires, Agilent offers repair by unit exchange service at competitive prices.

#### Extended Service Contracts

Many Agilent products are available with optional service contracts that extend the covered period after the standard warranty expires. If you have such a service contract and your instrument fails during the covered period, Agilent Technologies will replace it in accordance with the contract.

#### Obtaining Repair Service (Worldwide)

To obtain service for your instrument (in-warranty, under service contract, or post-warranty), contact your nearest Agilent Technologies Service Center. They will arrange to have your unit replaced, and can provide warranty or repair cost information where applicable.

To obtain warranty, service, or technical support information you can contact Agilent Technologies at one of the following telephone numbers:

In the United States: (800) 829-4444

In Europe: 31 20 547 2111

In Japan: 0120-421-345

Or use our Web link for information on contacting Agilent worldwide:

**[www.agilent.com/find/assist](http://www.agilent.com/find/assist)**

Or contact your Agilent Technologies Representative.

Before shipping your instrument, ask the Agilent Technologies Service Center to provide shipping instructions, including what components to ship. Agilent recommends that you retain the original shipping carton for use in such shipments.

## Repackaging for Shipment

If the unit is to be shipped to Agilent for service or repair, be sure to:

- Attach a tag to the unit identifying the owner and indicating the required service or repair. Include the model number and full serial number.
- Place the unit in its original carton with appropriate packaging material for shipping.
- Secure the container with strong tape or metal bands.
- If the original shipping container is not available, place your unit in a container which will ensure at least 4 inches of compressible packaging material around all sides for the instrument. Use static-free packaging materials to avoid additional damage to your unit.

*Agilent suggests that you always insure your shipments.*

## Cleaning

No cleaning is required for this product. If you wish to remove dust from the enclosure, use a dry cloth.

## Replacement Parts

This section contains information for ordering replacement parts for your instrument. The parts lists are divided into the following sections.

- Parts are listed in alphanumeric order according to their reference designators
- The parts lists include a brief description of each part with applicable Agilent part number.

### To Order Replaceable Parts

You can order replaceable parts from Agilent using the Agilent part number. Note that not all parts listed in this chapter are available as field-replaceable parts. To order replaceable parts from Agilent, do the following:

- 1 Contact your nearest Agilent Sales Office or Service Center.
- 2 Identify the parts by the Agilent part number shown in the replaceable parts list.
- 3 Provide the instrument model number and serial number.

**Table 5-6** Replaceable Parts

Part Number	Description
2110-0014	Fuse 4.0 A T for 100 Vac and 115 Vac (U8001A)
2110-0006	Fuse 2.0 A T for 230 Vac (U8001A)
2110-0722	Fuse 6.25 A T for 100 Vac and 115 Vac (U8002A)
2110-1425	Fuse 2.8 A T for 230 Vac (U8002A)



## Troubleshooting

This section provides a brief check list of common failures. Before troubleshooting or repairing the power supply, make sure that the failure is in the instrument rather than any external connections. Also make sure that the instrument is accurately calibrated.

### Unit is Inoperative

- Verify that the AC power cord is connected to the power supply.
- Verify that the front-panel power switch is at "ON" position.
- Verify the power-line voltage setting.
- Verify that the power-line fuse is installed:

Model	Agilent Part Number	Part Description
U8001A	2110-0014	Fuse 4.0 A T for 100 Vac and 115 Vac
	2110-0006	Fuse 2.0 A T for 230 Vac
U8002A	2110-0722	Fuse 6.25 A T for 100 Vac and 115 Vac
	2110-1425	Fuse 2.8 A T for 230 Vac

## Line Voltage Conversion

**WARNING**

**Shock Hazard. Operating personnel must not remove power supply covers. Component replacement and internal adjustment must be made only by qualified service personnel.**

---

Line voltage conversion is accomplished by adjusting two components: the line voltage selection switch and the power-line fuse on the rear panel.

- 1 Remove the power cord and slide the fuse cover upwards

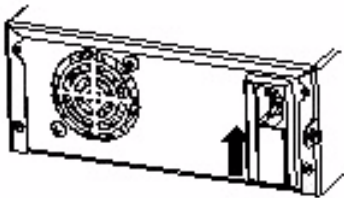

- 2 Pull the fuse plunger to remove the fuse from the

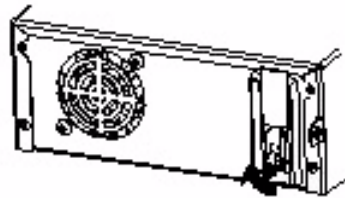

- 3 Remove the voltage selector PCB using a flat-blade screwdriver.

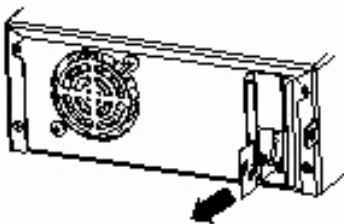

- 4 Replace the correct fuse and orientate the PCB based on the correct voltage.

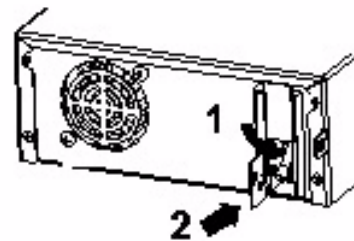

## Orientation of the Voltage Selector AC Inlet

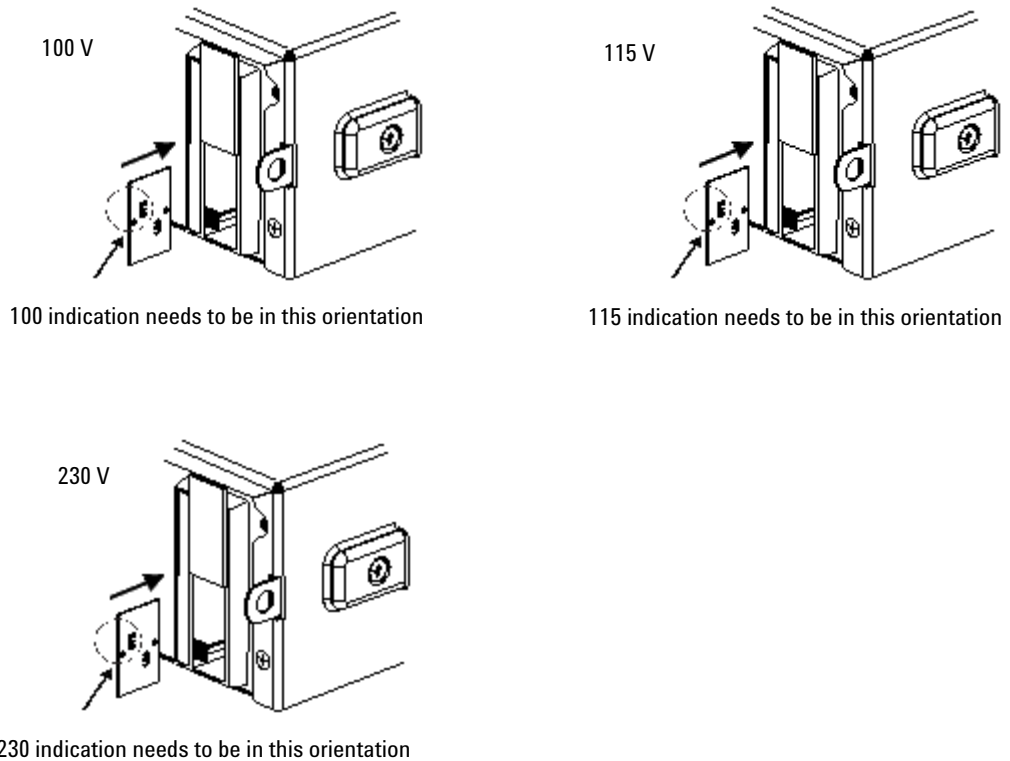

**Figure 5-6** Orientation of voltage selector AC inlet in different voltage selection

<b>RATING:</b> 47-63Hz 330VA	<b>FUSE:</b>	<b>~LINE:</b>
	4.0AT	100V <input type="checkbox"/>
		115V <input type="checkbox"/>
	2.0AT	230V <input type="checkbox"/>

Line Voltage Fuse Rating indicator for U8001A

<b>RATING:</b> 47-63Hz 500VA	<b>FUSE:</b>	<b>~LINE:</b>
	6.25AT	100V <input type="checkbox"/>
		115V <input type="checkbox"/>
	2.8AT	230V <input type="checkbox"/>

Line Voltage Fuse Rating indicator for U8002A

**NOTE**

The authorised personnel will mark the fuse rating indicator printed on the rear panel each time the fuse is changed.

## Self-Test Procedures

### Power-On Self-Test

Each time the power supply is powered on, a set of self-tests are performed. These tests check that the minimum set of logic and measurement hardware are functioning properly.

### Unit Fails Self-Test

Verify that the correct power-line voltage setting is selected. Also, ensure that all terminal connections are removed while the self-test is performed. Please refer to [“Appendix A: List of Error Codes”](#) for list of error codes.

## Performance Verification and Calibration

This chapter contains performance verification and calibration procedures. The performance verification procedures allow you to verify that the power supply is operating within its published specifications. The calibration procedures show how to make voltage and current adjustment on the power supply.

### Agilent Technologies Calibration Services

When your instrument is due for calibration, contact your local Agilent Service Center for a low-cost recalibration.

### Calibration Interval

One year interval is recommended for most applications. Accuracy specifications are warranted only if calibration is made at regular calibration interval. Accuracy specifications are not warranted beyond the one year calibration interval. Agilent does not recommend extending calibration intervals beyond two years for any application. Agilent recommends that complete re-adjustment should always be performed at the calibration interval. This will increase your confidence that the U8001A and U8002A will remain within specification for the next calibration interval. The re-adjustment provides the best long-term stability and accuracy.

## Recommended Test Equipment

The test equipment recommended for the calibration and adjustment is listed below. If the exact instrument is not available, substitute the calibration standards of equivalent requirement(s).

**Table 5-7** List of Equipment

Equipment	Requirement(s)	Recommended Model	Purpose	Used
Digital Multimeter (DMM)	8½ digits resolution	Agilent 3458A	Measures accurate DC voltage	PV* C†
Oscilloscope	<ul style="list-style-type: none"> <li>• Sensitivity: 1 mV</li> <li>• Bandwidth limit: 20 MHz</li> <li>• Probe:               <ul style="list-style-type: none"> <li>• 1:1 with RF tip</li> <li>• 10:1 with RF tip for &gt; 50 V</li> </ul> </li> </ul>	Agilent DSO8064A or Infiniium equivalent	Displays transient response. Displays ripple and noise waveform.	PV
Differential Amplifier	<ul style="list-style-type: none"> <li>• Bandwidth &gt; 20 MHz (bandwidth limit : 20 MHz)</li> <li>• AC coupling</li> <li>• Amplifier x10</li> </ul>	LeCroy DA1855A	Signal conditioning preamplifiers	PV
RMS Volt Meter	20 Hz to 20 MHz	R&S URE3	Measures RMS noise	PV
50 Ω Feed-through Termination		Pomona	Loads termination to match output impedance of the differential amplifier	PV
AC/DC Current Converter		Tektronix TCP305 & Tektronix TCPA300	Converts current to voltage	
Electronic Load	<ul style="list-style-type: none"> <li>• Voltage range: 30 Vdc</li> <li>• Current range: 5 A</li> <li>• Open and Short switches</li> <li>• Transient On/Off</li> </ul>	Agilent 6060B	Measures load and line regulations and transient response time	PV
AC Power Source	Capable of supplying 90 Vac to 250 Vac	Agilent 6813B	Functions as variable voltage transformer	PV

**Table 5-7** List of Equipment

Equipment	Requirement(s)	Recommended Model	Purpose	Used
Resistive Load ( $R_L$ )	<ul style="list-style-type: none"> <li>• 10 <math>\Omega</math>/90 W (for U8001A)</li> <li>• 6 <math>\Omega</math>/150 W (for U8002A)</li> </ul>		Measures ripple and noise	PV
Current Monitoring Resistor (Shunt) ( $R_M$ )	<ul style="list-style-type: none"> <li>• 0.01 <math>\Omega \pm 0.1\%</math></li> <li>• TCR less than 20 ppm/<math>^{\circ}\text{C}</math></li> </ul>	ISOTEK Co. Model A-H	Current monitoring resistor	PV C

\* PV = Performance Verification

† C = Calibration

## Test Consideration

For optimum performance, all procedures should comply with the following recommendations:

- Assure that the calibration ambient temperature is stable and between 20  $^{\circ}\text{C}$  and 30  $^{\circ}\text{C}$ . Ideally the calibration should be performed at 25  $^{\circ}\text{C} \pm 1$   $^{\circ}\text{C}$ .
- Assure ambient relative humidity is less than 80%.
- Allow one hour warm up period by power on the power supply. During warm up period, set the power supply to maximum programmable voltage and current. Then, enable the output.
- Keep the test setup connection cables as short as possible.

## Measurement Techniques

### Test Setup

Most tests are performed at the front terminals as shown below. Measure the DC voltage directly at the positive (+) and negative (-) terminals on the front panel.

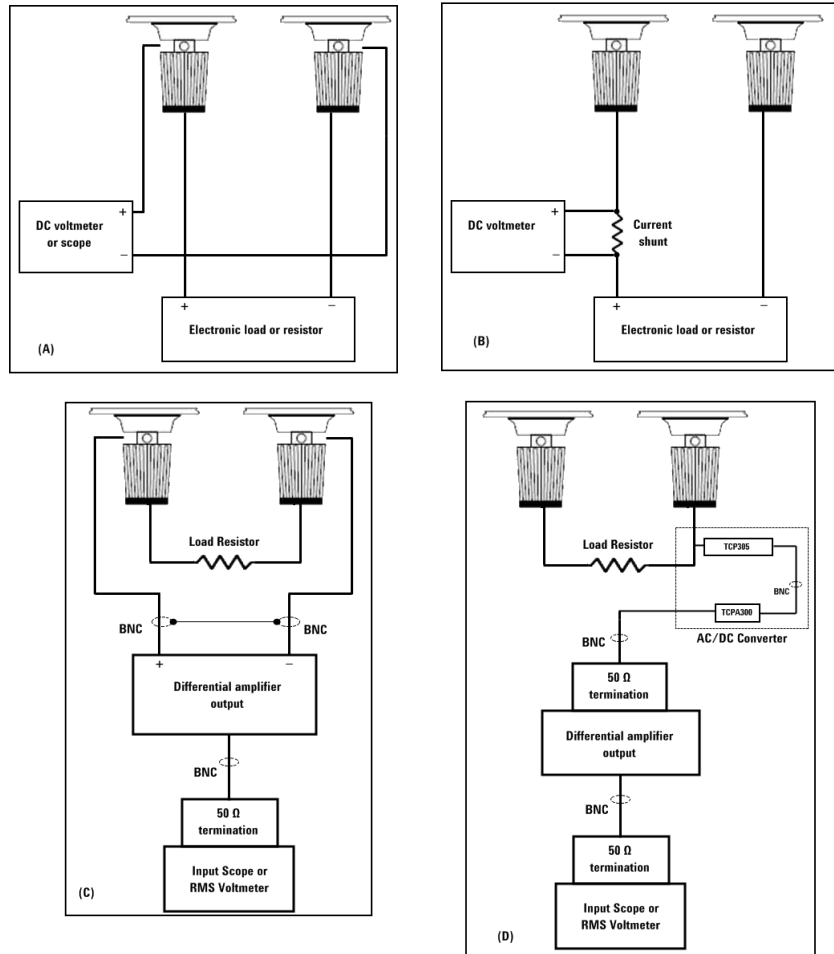

Figure 5-7 Test Setups



### Current Monitoring Resistor

To eliminate output current measurement error caused by the voltage drops in the leads and connections, connect the current monitoring resistor ( $R_M$ ) between the (-) output terminal and the load as a four-terminal device. Connect the current monitoring leads inside the load-lead connections directly at the monitoring points on the resistor element.

### General Measurement Techniques

To achieve best results when measuring load regulation, peak to peak voltage, and transient response time of the power supply, measuring devices must be connected through the hole in the neck of the binding post at (A) while the load resistor is plugged into the front of the output terminals at (B). A measurement made across the load includes the impedance of the leads to the load. The impedance of the load leads can easily be several orders of the magnitude greater than the power supply impedance and thus invalidate the measurement. To avoid mutual coupling effects, each measuring device must be connected directly to the output terminals by separate pairs of leads.

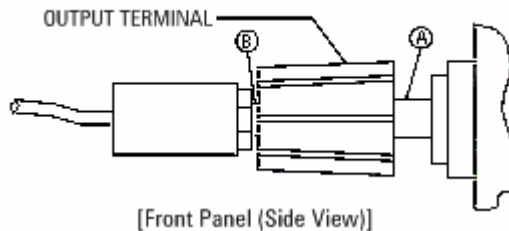

**Figure 5-8** General Measurement

### **Electronic Load**

Many of the test procedures require the use of a variable load resistor capable of dissipating the required power. Using a variable load resistor requires that switches should be used to connect, disconnect, and short the load resistor. An electronic load, if available, can be used in place of a variable load resistor and switches. The electronic load is considerably easier to use than load resistors. It eliminates the need for connecting resistors or rheostats in parallel to handle power, it is much more stable than carbon-pile load, and it makes easy work of switching between load conditions as is required for the load regulation and load response tests. Substitution of the electronic load requires minor changes to the test procedures in this chapter.

## Constant Voltage (CV) Verification

### Voltage Programming and Readback Accuracy

This test is to verify that the voltage programming and readback accuracy are within published specifications.

Procedures:

- 1 Power off the power supply and connect a DMM between the (+) and (-) terminals of the output to be tested. Remove the electronic load or resistor block as shown in [Figure 5-7 \(A\)](#), to operate as an open circuit.
- 2 Power on the power supply.
- 3 When the power supply is in limit mode, program the output voltage to 0 V and the output current to the maximum programmable value.
- 4 Enable the output.
- 5 Wait for a few seconds for the output of the power supply to settle. Make sure that the power supply is in CV mode.
- 6 Record the voltage reading on the DMM ( $V_{DMM}$ ). This value should be within the limit of  $0\text{ V} \pm 20\text{ mV}$ .
- 7 When the power supply is in meter mode, record the voltage reading displayed on the front display of the power supply. This value should be within the limit of  $V_{DMM} \pm 20\text{ mV}$ .
- 8 Disable the output.
- 9 When the power supply is in limit mode, program the output voltage to full rated value, i.e. 30 V.
- 10 Enable the output.
- 11 Wait for a few seconds for the output of the power supply to settle. Make sure that the power supply is in CV mode.
- 12 Record the voltage reading on the DMM ( $V_{DMM}$ ). This value should be within the limit of  $30\text{ V} \pm 0.125\text{ V}$ .
- 13 When the power supply is in meter mode, record the voltage reading displayed on the front display of the power supply. This value should be within the limit of  $V_{DMM} \pm 0.125\text{ V}$ .

### CV Load Effect (Load Regulation)

This test measures the change in the output voltage resulting from a change in the output current from full load to no load or vice versa.

Procedures:

- 1 Power off the power supply and connect a DMM between the (+) and (-) terminals of the output as shown in [Figure 5-7\(A\)](#).
- 2 Power on the power supply.
- 3 When the power supply is in limit mode, program the output voltage to full rated value, i.e. 30 V and output current to the maximum programmable value.
- 4 Enable the output.
- 5 Operate the electronic load in constant current mode and set its current to 3 A for U8001A and 5 A for U8002A. Ensure that the power supply is in CV mode. If not, adjust the electronic load so that the current drops slightly until the power supply is in CV mode.
- 6 Record the reading on the DMM.
- 7 Within a few seconds after step 6, operate the electronic load in open mode and record the reading on the DMM.
- 8 Compare the reading obtained in steps 5 and 6. The difference should be within the limit of 5 mV.

### CV Source Effect (Line Regulation)

This test measures the change in output voltage that results from a change in AC line voltage from the minimum value to maximum value.

Procedures:

- 1 Power-off the power supply and connect a DMM between the (+) and (-) terminals of the output to be tested as shown in [Figure 5-7\(A\)](#).
- 2 Connect the AC power line through an AC voltage source. Adjust the AC voltage source to provide nominal input voltage to the power supply.
- 3 Power on the power supply.
- 4 When the display is in the limit mode, program the output voltage to full rated value, i.e. 30 V and output current to the maximum programmable value.
- 5 Enable the output.
- 6 Operate the electronic load in constant current mode and set its current to 3 A for U8001A and 5 A for U8002A. Ensure that the power supply is in CV mode. If not, adjust the electronic load so that the output current drops slightly until the power supply is in CV mode.
- 7 Adjust the AC voltage source to low line voltage limit. Record the output reading on the DMM.
- 8 Within a few seconds after step 7, adjust the AC voltage source to high line voltage limit and record the voltage reading on the DMM.
- 9 The difference between the DMM readings in steps 7 and 8 should be within the limit of 5 mV.

Line Voltage	Low Line Voltage Limit, $V_{ac}$	High Line Voltage Limit, $V_{ac}$
100	90	110
115	104	127
230	207	253

## CV Noise

CV noise is specified as the RMS or peak-to-peak output voltage in the frequency range from 20 Hz to 20 MHz.

Procedures:

- 1 Power off the power supply and connect the output to be tested as shown in [Figure 5-7\(C\)](#) to a differential amplifier and load resistor (10  $\Omega$  for U8001A and 6  $\Omega$  for U8002A)
- 2 Power on the power supply.
- 3 When the display is in the limit mode, program the output voltage to full rated value, i.e. 30 V and output current to the maximum programmable value.
- 4 Enable the output of the power supply.
- 5 Make sure that the power supply is in CV mode. If not, adjust the resistive load so that the output current drops slightly until the power supply is in CV mode.
- 6 Configure the differential amplifier as follow:
  - Set to AC mode (positive and negative) to removes the DC component
  - Set to differential mode
  - Set gain to x10
  - Set attenuation to 1
  - Set low pass filter to 20 MHz bandwidth limit to filter out input signal which contains higher frequency
  - Set to zero precision voltage generator
  - Set input impedance to 1 M $\Omega$
- 7 Configure the scope as follow:
  - Set time range to 50 ms (20 Hz)
  - Acquires every single sample at the maximum sampling rate and retains only the min and max values in a "sampling region" (50 ms time range)
  - Enable 20 MHz cut off frequency for better high frequency cut-off
  - AC coupling

- Enable Auto-triggering
- 8** Allow the scope run for a few seconds to generate enough measurement points.
  - 9** Obtain the maximum peak-to-peak voltage measurement as indicated in the scope. Divide this value by 10 to get the CV peak-to-peak noise measurement. The result should not exceed  $12 \text{ mV}_{\text{pp}}$ .
  - 10** Configure the RMS voltmeter as below:
    - Set high pass filter to 10 Hz
    - AC coupling
  - 11** Disconnect the oscilloscope and connect an RMS voltmeter in its place. Do not disconnect the  $50 \Omega$  termination. Divide the reading of the RMS voltmeter by 10. The result should not exceed the RMS limits of  $1 \text{ mV}_{\text{RMS}}$ .

### Load Transient Response Time

This test measures the time for the output voltage to recover to within 15 mV of nominal output voltage following a load change from full load to half load or vice versa.

Procedures:

- 1 Power off the power supply and connect the output to be tested as shown in [Figure 5-7\(A\)](#) with an oscilloscope. Operate the electronic load in constant current mode.
- 2 Power on the power supply.
- 3 When the display is in the limit mode, program the output voltage to full rated value, i.e. 30 V and output current to the maximum programmable value.
- 4 Enable the output.
- 5 Set the electronic load to transient operation mode between one half of the output's full rated value and the output's full rated value at a 1 kHz rate with 50% duty cycle.
- 6 Set the oscilloscope coupling, internal sync and lock on either the positive or negative load transient.
- 7 Adjust the oscilloscope to display transients as shown in [Figure 5-9](#). Note that the pulse width ( $t_2-t_1$ ) of the transients at 15 mV from the base line is no more than 50  $\mu$ s for the output.



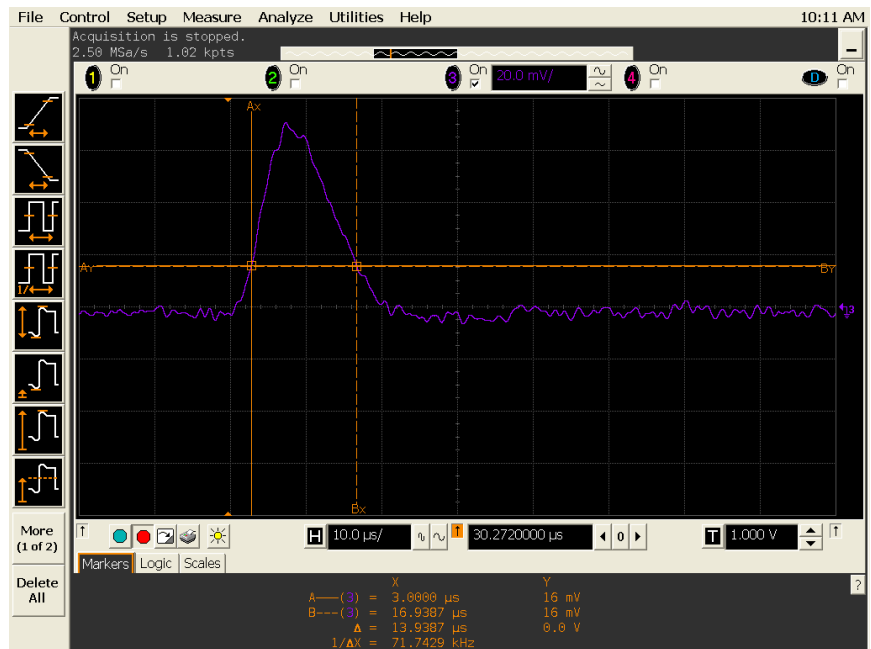

Figure 5-9 Graph of load transient response

## Constant Current (CC) Verification

### Current Programming and Readback Accuracy

This test is to verify that the current programming and readback accuracy are within published specifications. The accuracy of the current monitoring resistor must be 0.1% or better.

Procedures:

- 1 Power-off the power supply and connect a 0.01  $\Omega$  current shunt monitoring resistor ( $R_M$ ) across the output to be tested and a DMM across the current monitoring resistor ( $R_M$ ).
- 2 Power on the power supply.
- 3 When the power supply is in limit mode, program the output voltage to maximum programmable value and the current to 0 A.
- 4 Enable the output.
- 5 Wait for a few seconds for the output of the power supply to settle. Make sure that the power supply is in CC mode.
- 6 Divide the voltage drop (DMM reading) across the current monitoring resistor ( $R_M$ ) by its resistance to convert to amps and record this value ( $I_O$ ). This value should be within the limit of 0 A  $\pm$ 20 mA.
- 7 When the power supply is in meter mode, record the current reading displayed on the front display of the power supply. This value should be within the limit of  $I_O \pm$ 20 mA.
- 8 Disable the output.
- 9 When the power supply is in limit mode, program the output current to full rated value, i.e. 3 A for U8001A and 5 A for U8002A.
- 10 Enable the output.
- 11 Wait for a few seconds for the output of the power supply to settle. Make sure that the power supply is in CC mode.

**12** Divide the voltage drop (DMM reading) across the current monitoring resistor ( $R_M$ ) by its resistance to convert to amps and record this value ( $I_O$ ). This value should be within the limit of:

- U8001A: 3 A  $\pm$ 30.5 mA
- U8002A: 5 A  $\pm$ 37.5 mA

**13** When the power supply is in meter mode, record the current reading displayed on the front display of the power supply. This value should be within the limit of:

- U8001A:  $I_O \pm$ 30.5 mA
- U8002A:  $I_O \pm$ 37.5 mA

### CC Load Effect (Load Regulation)

This test measures the immediate change in output current resulting from a change in the load from full rated output voltage to short circuit.

Procedures:

- 1 Power off the power supply and connect the output to be tested as shown in [Figure 5-7\(B\)](#) with the DMM connected across the 0.01  $\Omega$  current monitoring resistor ( $R_M$ ).
- 2 Power on the power supply.
- 3 When the power supply is in limit mode, program the output voltage to maximum programmable value and output current to full rated value, i.e. 3 A for U8001A and 5A for U8002A.
- 4 Enable the output.
- 5 Operate the electronic load in constant voltage mode and set its voltage to 30 V. Ensure that the power supply is in CC mode. If not, adjust the electronic load so that the voltage drops slightly until the power supply is in CC mode.
- 6 Record the current reading by dividing the voltage reading on the DMM by the resistance of the current monitoring resistor.
- 7 Within a few seconds after step 6, operate the electronic load in short mode and record the current reading by dividing the voltage reading on the DMM by the resistance of the current monitoring resistor.
- 8 Compare the reading obtained in steps 6 and 7. The difference should be within the limit of:
  - U8001A: 2.6 mA
  - U8002A: 3 mA

### CC Source Effect (Line Regulation)

This test measures the change in output current that results from a change in AC line voltage from the minimum value to the maximum value.

Procedures:

- 1** Power off the power supply and connect the output to be tested as shown in [Figure 5-7\(B\)](#) with the DMM connected across the current monitoring resistor ( $R_M$ ).
- 2** Connect the AC power line through an AC voltage source. Adjust the AC voltage source to provide nominal input voltage to the power supply.
- 3** Power on the power supply.
- 4** When the display is in the limit mode, program the output voltage to maximum programmable value and output current to full rated value, i.e. 3 A for U8001A and 5 A for U8002A.
- 5** Enable the output.
- 6** Operate the electronic load in constant voltage mode and set its voltage to 30 V. Ensure that the power supply is in CC mode. If not, adjust the electronic load so that the output voltage drops slightly until the power supply is in CC mode.
- 7** Adjust the AC voltage source to low line voltage limit. Record the output current reading by dividing the voltage reading on the DMM by the resistance of the current monitoring resistor.
- 8** Within a few seconds after step 7, adjust the AC voltage source to high line voltage limit and record the output current reading by dividing the voltage reading on the DMM by the resistance of the current monitoring resistor.

9 Compare the reading obtained in steps 7 and 8. The difference should be within the limit of:

- U8001A: 2.6 mA
- U8002A: 3 mA

Line Voltage	Low Line Voltage Limit, $V_{ac}$	High Line Voltage Limit, $V_{ac}$
100	90	110
115	104	127
230	207	253

## CC Noise

CC noise is specified as the RMS output current in a frequency range 20 Hz to 20 MHz with the power supply in constant current operation.

Procedures:

- 1** Power off the power supply and connect the output to be tested as shown in [Figure 5-7\(D\)](#) to an AC/DC converter and load resistor (10  $\Omega$  for U8001A and 6  $\Omega$  for U8002A).
- 2** Power on the power supply.
- 3** When the display is in the limit mode, program the output voltage to maximum programmable value and output current to full rated value, i.e. 3 A for U8001A and 5 A for U8002A.
- 4** Enable the output.
- 5** Make sure that the power supply is in CC mode. If not, adjust the resistive load so that the output voltage drops slightly until the power supply is in CC mode.
- 6** Configure the differential amplifier as follow:
  - Set to AC mode (positive and negative) to removes the DC component
  - Set to differential mode
  - Set gain to x10
  - Set attenuation to 1
  - Set low pass filter to 20 MHz bandwidth limit to filter out input signal which contains higher frequency
  - Set to zero precision voltage generator
  - Set input impedance to 1 M $\Omega$
- 7** Configure the RMS voltmeter as follow:
  - Set high pass filter to 10 Hz
  - AC coupling
- 8** Divide the reading of the RMS voltmeter by 10 and then multiply the result by 5 to get the RMS noise measurement. The result should not exceed the RMS limits of 3 mA<sub>RMS</sub>.

## Voltage Calibration

Before attempting to calibrate the power supply, please ensure that you have disconnected all loads from the power supply and connect a digital voltmeter (DVM) across the output terminals. You will be calibrating for low voltage, middle voltage and high voltage point respectively. Make sure that the power supply is in constant voltage (CV) mode along the voltage calibration.

### 1 Enter calibration mode.



- In order to enter the calibration mode, hold down the **Memory** button when power on the power supply.
- The output is enabled.
- The calibration will start with voltage calibration mode.
- Display will show "C" blinking.
- The CV annunciator will be turned on.
- Ensure that the power supply is in CV mode. Otherwise, the CC annunciator will fast-blink.

### 2 Low Voltage Calibration Point.



- Display will show "C" blinking.
- The M1 annunciator will be turned on.
- Use the knob to enter the reading obtained from the DVM.
- Press the "Memory" button to save the changes and move to the next calibration point. You will be able to perform this if the power supply is in CV mode.

### 3 Middle Voltage Calibration Point.



- Display will show "C" blinking.
- The M2 annunciator will be turned on.
- Use the knob to enter the reading obtained from the DVM.
- Press the "Memory" button to save the changes and move to the next calibration point. You will be able to perform this if the power supply is in CV mode.



#### 4 High Voltage Calibration Point.

- Display will show "C" blinking.
- The M3 annunciator will be turned on.
- Use the knob to enter the reading obtained from the DVM.
- Press the "Memory" button to save the changes voltage calibration is done. You will be able to perform this if the power supply is in CV mode.



#### 5 Voltage Calibration

- Display will show "donE" for a few seconds and the power supply will enter the current calibration mode.

#### NOTE

If you do not wish to continue with the current calibration, you may now turn off the power supply to exit the calibration mode.

---

## Current Calibration

For current calibration, connect an appropriate shunt  $0.01\ \Omega$  across the output terminals, and connect a digital voltmeter (DVM) across the shunt resistor. Same as voltage calibration, you will also be calibrating for low current, middle current and high current calibration point respectively. Make sure that the power supply is in constant current (CC) mode along the current calibration.

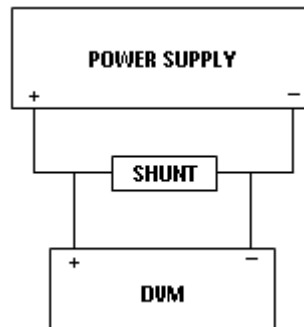

### 1 Current Calibration mode

- Display will show "C" blinking.
- The CC annunciator will be turned on.
- Ensure that the power supply is in CC mode. Otherwise the CV annunciator will fast-blink.

### 2 Low current calibration point.

- Display will show "C" blinking.
- The M1 annunciator will be turned on.
- Use the knob to enter the computed value (DVM reading divided by shunt resistance).
- Press the "Memory" button to save the changes and move to the next calibration point. You will be able to perform this if the power supply is in CC mode.



**3 Middle current calibration point.**

- Display will show "C" blinking.
- The M2 annunciator will be turned on.
- Use the knob to enter the computed value (DVM reading divided by shunt resistance).
- Press the "Memory" button to save the changes and move to the next calibration point. You will be able to perform this if the power supply is in CC mode.

**4 High current calibration point.**

- Display will show "C" blinking.
- The M3 annunciator will be turned on.
- Use the knob to enter the computed value (DVM reading divided by shunt resistance).
- Press the "Memory" button to save the changes and the whole calibration process is done. You will be able to perform this if the power supply is in CC mode.

**5 Calibration done**

- Display will show "donE CAL"
- The output is disabled and the OFF annunciator will be turned on.

**6 Reenter calibration mode**

- Press the "Memory" button to reenter the calibration mode. The calibration will start with voltage calibration mode.

**7 Exit calibration mode**

- Turn off the power supply to exit the calibration mode.

**8 Toggle between calibration modes**

- Along the calibration process, you can toggle between voltage calibration mode and current calibration mode by pressing the "Voltage/Current" button.





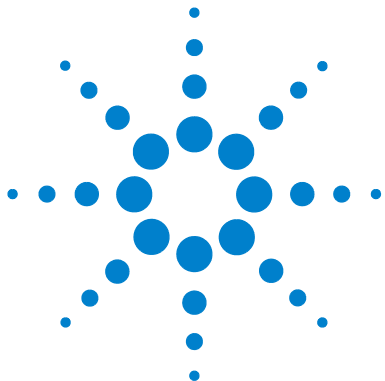

## Appendix

Appendix A: List of Error Codes 58



## Appendix A: List of Error Codes

The following table contains the list of error codes and the interpretations for each code.

### Operation Errors

Codes	Descriptions
101	Flash read/write failed
102	Invalid calibration data
111	Temperature too high

### Calibration Errors

Codes	Descriptions
201	Flash read/write failed
211	Calibration failed for DAC CV
212	Calibration failed for DAC CC
213	Calibration failed for ADC CV
214	Calibration failed for ADC CC
215	Calibration failed for DAC OV
216	Calibration failed for DAC OC

**www.agilent.com**

Contact us

To obtain service, warranty or technical support assistance, contact us at the following phone numbers:

United States:

(tel) 800 829 4444 (fax) 800 829 4433

Canada:

(tel) 877 894 4414 (fax) 800 746 4866

China:

(tel) 800 810 0189 (fax) 800 820 2816

Europe:

(tel) 31 20 547 2111

Japan:

(tel) (81) 426 56 7832 (fax) (81) 426 56 7840

Korea:

(tel) (080) 769 0800 (fax) (080) 769 0900

Latin America:

(tel) (305) 269 7500

Taiwan:

(tel) 0800 047 866 (fax) 0800 286 331

Other Asia Pacific Countries:

(tel) (65) 6375 8100 (fax) (65) 6755 0042

Or visit Agilent worldwide web at:

[www.agilent.com/find/assist](http://www.agilent.com/find/assist)

Product specifications and descriptions in this document subject to change without notice. Always refer to the English version at the Agilent Web site for the latest revision.

© Agilent Technologies, Inc. 2008–2013

Printed in Malaysia  
Fifth Edition, July 12, 2013  
U8001-90001



**Agilent Technologies**