

# **Agilent U2741A USB Modular 5.5 Digits Digital Multimeter**

## **User's Guide**



**Agilent Technologies**

## Notices

© Agilent Technologies, Inc. , 2008–2013

No part of this manual may be reproduced in any form or by any means (including electronic storage and retrieval or translation into a foreign language) without prior agreement and written consent from Agilent Technologies, Inc. as governed by United States and international copyright laws.

### Manual Part Number

U2741-90001

### Edition

Sixth Edition, August 2, 2013

Agilent Technologies, Inc.  
5301 Stevens Creek Blvd.  
Santa Clara, CA 95051 USA

### Trademark Acknowledgements

Pentium is a U.S. registered trademark of Intel Corporation.

Microsoft, Visual Studio, Windows, and MS Windows are trademarks of Microsoft Corporation in the United States and/or other countries.

### Warranty

**The material contained in this document is provided “as is,” and is subject to being changed, without notice, in future editions. Further, to the maximum extent permitted by applicable law, Agilent disclaims all warranties, either express or implied, with regard to this manual and any information contained herein, including but not limited to the implied warranties of merchantability and fitness for a particular purpose. Agilent shall not be liable for errors or for incidental or consequential damages in connection with the furnishing, use, or performance of this document or of any information contained herein. Should Agilent and the user have a separate written agreement with warranty terms covering the material in this document that conflict with these terms, the warranty terms in the separate agreement shall control.**

### Technology Licenses

The hardware and/or software described in this document are furnished under a license and may be used or copied only in accordance with the terms of such license.

### Restricted Rights Legend

U.S. Government Restricted Rights. Software and technical data rights granted to the federal government include only those rights customarily provided to end user customers. Agilent provides this customary commercial license in Software and technical data pursuant to FAR 12.211 (Technical Data) and 12.212 (Computer Software) and, for the Department of Defense, DFARS 252.227-7015 (Technical Data - Commercial Items) and DFARS 227.7202-3 (Rights in Commercial Computer Software or Computer Software Documentation).

### Safety Notices

#### CAUTION

A **CAUTION** notice denotes a hazard. It calls attention to an operating procedure, practice, or the like that, if not correctly performed or adhered to, could result in damage to the product or loss of important data. Do not proceed beyond a **CAUTION** notice until the indicated conditions are fully understood and met.

---

















#### WARNING

A **WARNING** notice denotes a hazard. It calls attention to an operating procedure, practice, or the like that, if not correctly performed or adhered to, could result in personal injury or death. Do not proceed beyond a **WARNING** notice until the indicated conditions are fully understood and met.

---

## Safety Symbols

The following symbols on the instrument and in the documentation indicate precautions which must be taken to maintain safe operation of the instrument.

	Direct current (DC)		Off (supply)
	Alternating current (AC)		On (supply)
	Both direct and alternating current		Caution, risk of electric shock
	Three-phase alternating current		Caution, risk of danger (refer to this manual for specific Warning or Caution information)
	Earth (ground) terminal		Caution, hot surface
	Protective conductor terminal		Out position of a bi-stable push control
	Frame or chassis terminal		In position of a bi-stable push control
	Equipotentiality	<b>CAT II 300 V</b>	Category II 300 V overvoltage protection
	Equipment protected throughout by double insulation or reinforced insulation		

## General Safety Information

### WARNING

- **Do not use the device if it is damaged. Before you use the device, inspect the casing. Look for cracks or missing plastic. Do not operate the device around explosive gas, vapor, or dust.**
  - **Always use the device with the cables provided.**
  - **Observe all markings on the device before establishing any connection.**
  - **Turn off the device and application system power before connecting to the I/O terminals.**
  - **When servicing the device, use only the specified replacement parts.**
  - **Do not operate the device with the cover removed or loosened.**
  - **Use only the power adapter provided by the manufacturer to avoid any unexpected hazards.**
- 

### CAUTION

- If the device is used in a manner not specified by the manufacturer, the device protection may be impaired.
  - Always use dry cloth to clean the device. Do not use ethyl alcohol or any other volatile liquid to clean the device.
  - Do not permit any blockage of the ventilation holes of the device.
-

## Environmental Conditions

This instrument is designed for indoor use and in an area with low condensation. The table below shows the general environmental requirements for this instrument.







Environmental conditions	Requirements
Operating temperature	0 °C to 55 °C
Operating humidity	20% to 85% RH non-condensing
Storage temperature	–20 °C to 70 °C
Storage humidity	5% to 90% RH non-condensing

### CAUTION

The U2741A USB modular digital multimeter complies with the following safety and EMC requirements.

- IEC 61010-1:2001/EN61010-1:2001 (2nd Edition)
- Canada: CAN/CSA-C22.2 No. 61010-1-04
- USA: ANSI/UL 61010-1:2004
- IEC 61326-2002/EN 61326:1997+A1:1998+A2:2001+A3:2003
- Canada: ICES-001:2004
- Australia/New Zealand: AS/NZS CISPR11:2004

## Regulatory Markings

	<p>The CE mark is a registered trademark of the European Community. This CE mark shows that the product complies with all the relevant European Legal Directives.</p>		<p>The C-tick mark is a registered trademark of the Spectrum Management Agency of Australia. This signifies compliance with the Australia EMC Framework regulations under the terms of the Radio Communication Act of 1992.</p>
<p><b>ICES/NMB-001</b></p>	<p>ICES/NMB-001 indicates that this ISM device complies with the Canadian ICES-001. Cet appareil ISM est conforme a la norme NMB-001 du Canada.</p>		<p>This instrument complies with the WEEE Directive (2002/96/EC) marking requirement. This affixed product label indicates that you must not discard this electrical/electronic product in domestic household waste.</p>
	<p>The CSA mark is a registered trademark of the Canadian Standards Association.</p>		

## **Waste Electrical and Electronic Equipment (WEEE) Directive 2002/96/EC**

This instrument complies with the WEEE Directive (2002/96/EC) marking requirement. This affixed product label indicates that you must not discard this electrical/electronic product in domestic household waste.

Product Category:

With reference to the equipment types in the WEEE directive Annex 1, this instrument is classified as a "Monitoring and Control Instrument" product.

The affixed product label is as shown below.



**Do not dispose in domestic household waste**

**To return this unwanted instrument, contact your nearest Agilent Technologies, or visit:**

**[www.agilent.com/environment/product](http://www.agilent.com/environment/product)**

**for more information.**

## In This Guide...

### **1 Getting Started**

This chapter provides an overview of the U2741A USB modular digital multimeter, the product outlook, product dimension, and product layout. This chapter contains instructions on how to install and configure to get started with the U2741A.

### **2 Operation and Features**

In this chapter, you will get to learn more about the operations and features that are offered by the U2741A.

### **3 Measurement Tutorial**

In this chapter, you will learn what are the common sources of error in measurements and how to minimize or eliminate these errors.

### **4 Characteristics and Specifications**

This chapter covers the characteristics and specifications of the U2741A.



## Declaration of Conformity (DoC)

The Declaration of Conformity (DoC) for this instrument is available on the Web site. You can search the DoC by its product model or description.

<http://regulations.corporate.agilent.com/DoC/search.htm>

### NOTE

If you are unable to search for the respective DoC, please contact your local Agilent representative.

---

**THIS PAGE HAS BEEN INTENTIONALLY LEFT BLANK.**

# Contents

	<b>List of Figures</b>	XIII
	<b>List of Tables</b>	XV
<b>1</b>	<b>Getting Started</b>	<b>1</b>
	Introduction	2
	Product at a Glance	3
	Product Outlook	3
	Product Dimensions	5
	Dimensions without Bumpers	5
	Dimensions with Bumpers	6
	Standard Shipped Items	7
	Inspection and Maintenance	8
	Initial Inspection	8
	Electrical Check	8
	General Maintenance	9
	Installation and Configuration	10
	Instrument Configuration	11
	55-Pin Backplane Connector Pin Configuration	11
	Chassis Installation	12
<b>2</b>	<b>Operation and Features</b>	<b>27</b>
	Powering Up	28
	Making Measurements	29
	Measuring DC Voltage	29

## Contents

Measuring AC Voltage	31
Measuring DC Current	32
Measuring AC Current	33
Measuring Resistance	34
Measuring Frequency	36
Testing Continuity	37
Testing Diodes	38
Measuring Temperature	39
Restoring Instrument State	41
Autozero	41
Ranging	42
Default Settings	43
Triggering the U2741A	44
System-Related Operation	46
Error Conditions	46
<b>3 Measurement Tutorial</b>	<b>47</b>
DC Measurement Considerations	48
Noise Rejection	49
Resistance Measurement Considerations	52
AC Measurements	55
Other Primary Measurement Functions	58
Frequency Measurement Errors	58
DC Current Measurements	58
Other Sources of Measurement Error	60
<b>4 Characteristics and Specifications</b>	<b>63</b>
Product Characteristics	65
Product Specifications	67

## List of Figures

Figure 1-1	55-pin backplane connector pin configuration	11
Figure 3-1	Common mode source error	49
Figure 3-2	Ground loop induced error	51
Figure 3-3	Burden voltage in current measurement	59

**THIS PAGE HAS BEEN INTENTIONALLY LEFT BLANK.**

## List of Tables

Table 1-1	SSI connector pin description	11
Table 2-1	Default settings summary	43
Table 3-1	Thermoelectric voltage for dissimilar metals connections	48
Table 3-2	Power dissipation for various resistance ranges	54
Table 3-3	Waveform shapes and their parameters	55
Table 4-1	DC accuracy	67
Table 4-2	AC accuracy for voltage	68
Table 4-3	Temperature coefficient for voltage	69
Table 4-4	AC accuracy for current <sup>[1]</sup>	69
Table 4-5	Temperature coefficient for current	69
Table 4-6	Frequency accuracy	70
Table 4-7	Frequency sensitivity for AC voltage	70
Table 4-8	Temperature accuracy	71

**THIS PAGE HAS BEEN INTENTIONALLY LEFT BLANK.**





# 1 Getting Started

Introduction	2
Product at a Glance	3
Product Outlook	3
Product Dimensions	5
Dimensions without Bumpers	5
Dimensions with Bumpers	6
Standard Shipped Items	7
Inspection and Maintenance	8
Initial Inspection	8
Electrical Check	8
General Maintenance	9
Installation and Configuration	10
Instrument Configuration	11
55-Pin Backplane Connector Pin Configuration	11
Chassis Installation	12



## Introduction

The Agilent U2741A is a 5.5 digits digital multimeter that can operate as standalone or as a modular unit when used with the U2781A USB modular instrument chassis.

U2741A can perform the following measurements:

- DC Voltage
- AC Voltage
- DC Current
- AC Current
- Resistance
- Diode Test
- Continuity Test
- Temperature
- Frequency

The U2741A is controlled remotely over a USB interface via the Agilent Measurement Manager (AMM) software. The U2741A can also be programmed using the provided drivers or via SCPI commands in your customized application.

# Product at a Glance

## Product Outlook

Top view

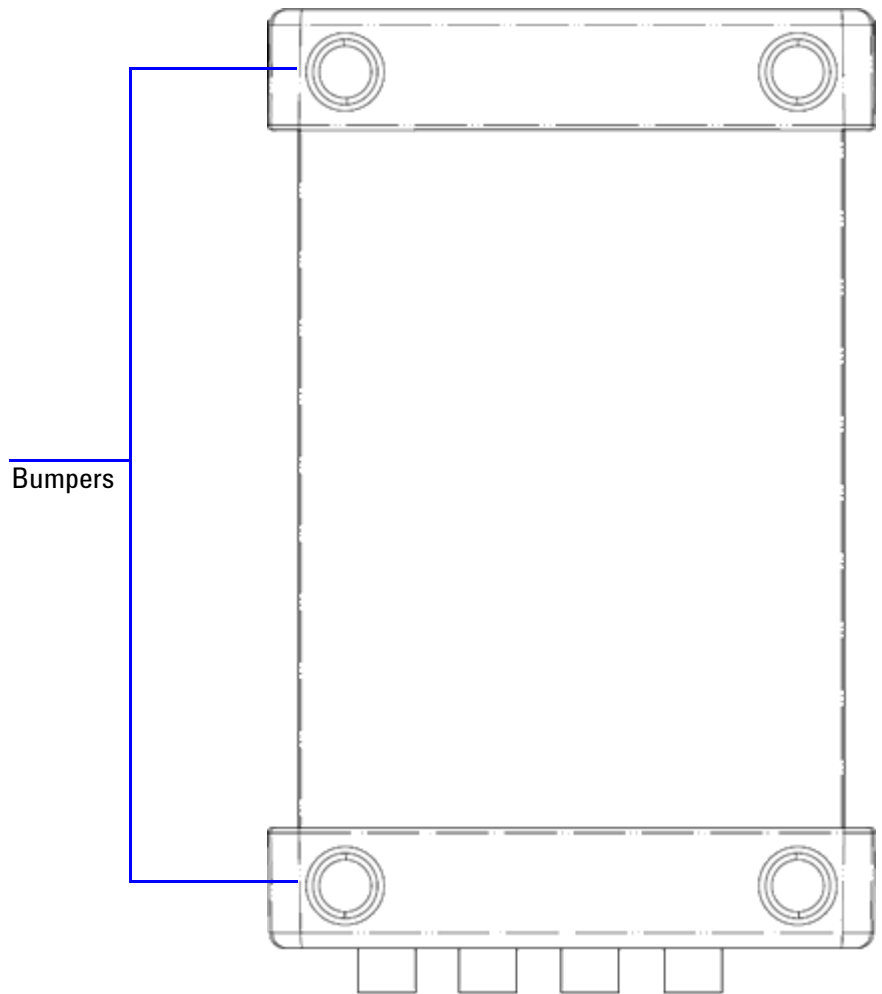

Front view

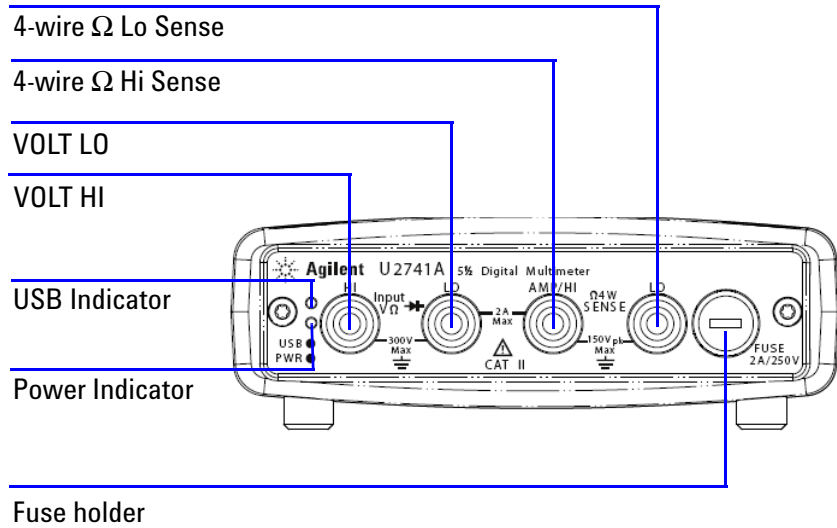

Rear view

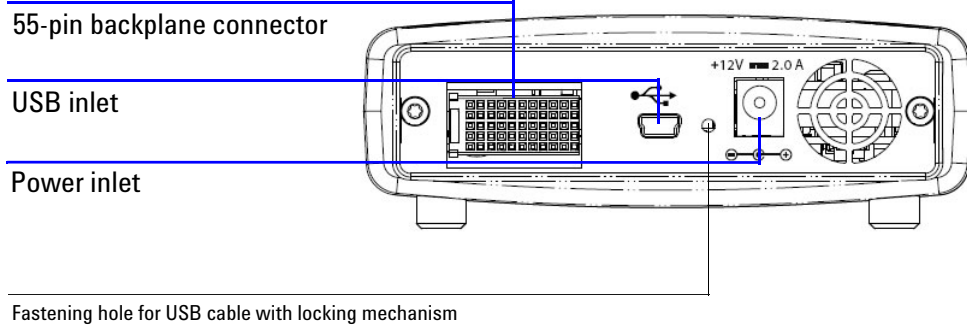

# Product Dimensions

## Dimensions without Bumpers

Top view

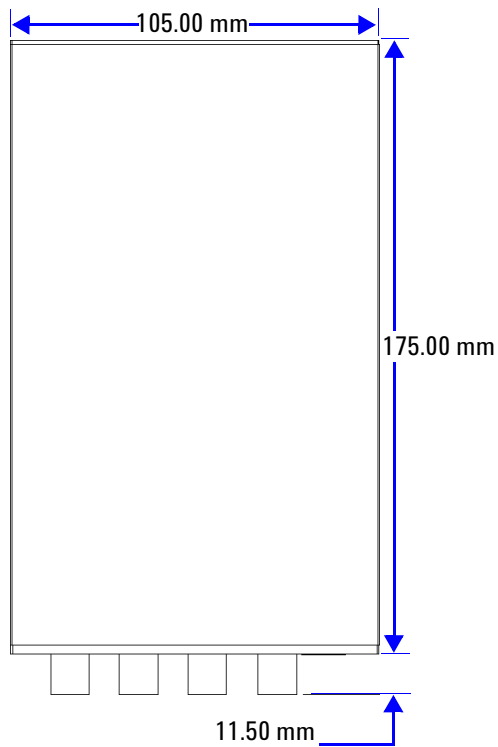

Front view

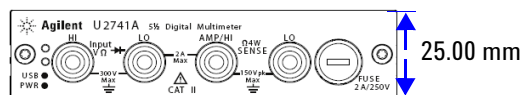

## Dimensions with Bumpers

Top view

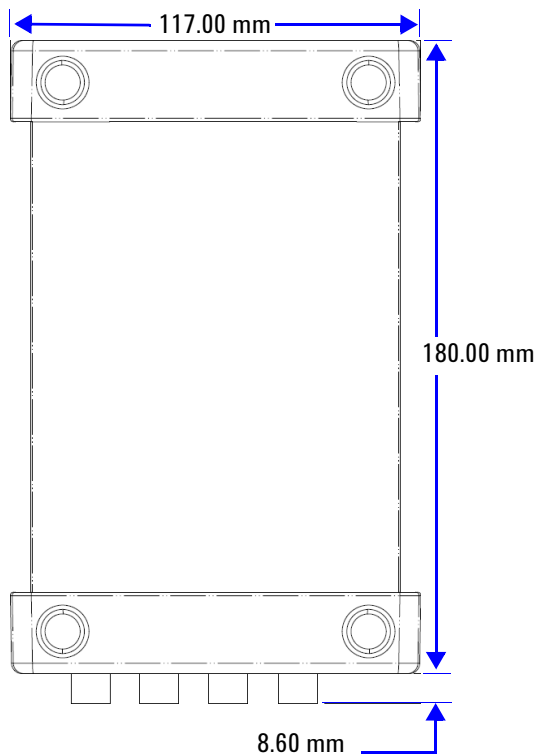

Front view

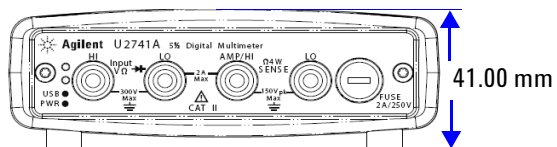

## Standard Shipped Items

Verify that you have received the following items with your unit. If anything is missing or damaged, please contact the nearest Agilent Sales Office.

- ✓ 12 V, 2 A AC/DC adapter
- ✓ Power cord
- ✓ Standard Test Lead
- ✓ USB Standard-A to Mini-B interface cable
- ✓ L-Mount kit (used with the modular instrument chassis)
- ✓ Agilent Automation-Ready CD-ROM (contains the Agilent IO Libraries Suite)
- ✓ Agilent USB Modular Products and Systems Quick Start Guide
- ✓ Agilent USB Modular Products and Systems Product Reference DVD-ROM
- ✓ Agilent Measurement Manager Quick Reference Card
- ✓ Certificate of Calibration

## Inspection and Maintenance

### Initial Inspection

When you receive your U2741A, inspect the unit for any obvious damage such as broken terminals or cracks, dents, and scratches on the casing that may occur during shipment.

If any damage is found, notify the nearest Agilent Sales Office immediately. The front of this manual contains the warranty information.

Keep the original packaging in case the U2741A has to be returned to Agilent in the future. If you return the U2741A for service, attach a tag identifying the owner and model number. Also include a brief description of the problem.

### Electrical Check

For verification procedures, refer to *Agilent U2741A USB Modular 5.5 Digits Digital Multimeter Service Guide*. The procedures will verify to a high level of confidence that the U2741A is operating in accordance to its specifications.



## General Maintenance

### General maintenance

**NOTE**

Any repair that is not covered in your modular product manuals should only be performed by qualified personnel.

---

- 1** Power off your module and remove the power cord and I/O cable from your device.
- 2** Remove your module from the bumper casing.
- 3** Shake out any dirt that may have accumulated on the module.
- 4** Wipe your module with a dry cloth and install the bumper back in place.

## Installation and Configuration

Follow the step-by-step instructions shown in the *Agilent USB Modular Products and Systems Quick Start Guide* to get started with the preparations and installations of your U2741A.

**NOTE**

You need to install the IVI-COM driver if you are going to use the U2741A with Agilent VEE Pro, LabVIEW, or Microsoft® Visual Studio®.

---

## Instrument Configuration

### 55-Pin Backplane Connector Pin Configuration

The 55-pin backplane connector is used when the U2741A module is inserted into the U2781A USB modular instrument chassis. For more details, refer to the *Agilent U2781A USB Modular Instrument Chassis User's Guide*.

GND	GND	GND	GND	GND	GND	GND	GND	GND	GND	GND	F
NC	NC	NC	NC	NC	NC	NC	NC	VBUS	GND	USB_D-	E
GND	TRIG3	GND	TRIG2	GND	TRIG1	GND	TRIG0	GND	GND	USB_D+	D
TRIG4	GND	TRIG5	GND	TRIG6	GND	TRIG7	GND	+12 V	+12 V	GND	C
nBPUB	CLK10M	GND	STAR_TRIG	GA2	GA1	GA0	NC	+12 V	+12 V	+12 V	B
NC	NC	NC	NC	NC	NC	NC	NC	+12 V	+12 V	+12 V	A
<b>11</b>	<b>10</b>	<b>9</b>	<b>8</b>	<b>7</b>	<b>6</b>	<b>5</b>	<b>4</b>	<b>3</b>	<b>2</b>	<b>1</b>	

**Figure 1-1** 55-pin backplane connector pin configuration

**Table 1-1** SSI connector pin description

SSI timing signal	Functionality
GND	Ground
NC	Not connected
VBUS	USB bus power sensing input
USB_D+, USB_D-	USB differential pair
TRIG0~TRIG7	Trigger bus
+12 V	+12 V power with 4 A current
nBPUB	USB backplane input detect

**Table 1-1** SSI connector pin description

<b>SSI timing signal</b>	<b>Functionality</b>
CLK10M	10 MHz clock source
STAR_TRIG	Star trigger
GA0,GA1,GA2	Geographical address pin

## Chassis Installation

The L-Mount kit is to be installed to your U2741A module.

The following instructions describe the simple procedure of installing the L-Mount kit and your module in the chassis.

- 1** Unpack the L-Mount kit from the packaging.
- 2** Remove your U2741A module from the bumper casing.
- 3** Use a Phillips screwdriver to fasten the L-Mount kit to your U2741A module.
- 4** Insert your U2741A module into the U2781A chassis with the 55-pin backplane connector positioned at the bottom of the module.
- 5** Once you have slotted in the module, tighten the screws of the L-Mount kit to secure the connection.

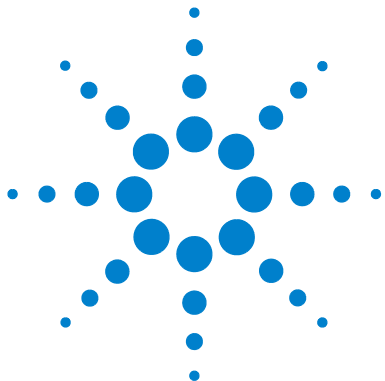

## 2 Operation and Features

Powering Up	28
Making Measurements	29
Measuring DC Voltage	29
Measuring AC Voltage	31
Measuring DC Current	32
Measuring AC Current	33
Measuring Resistance	34
Measuring Frequency	36
Testing Continuity	37
Testing Diodes	38
Measuring Temperature	39
Restoring Instrument State	41
Autozero	41
Ranging	42
Default Settings	43
Triggering the U2741A	44
System-Related Operation	46
Error Conditions	46

This chapter contains the details on how to configure your U2741A USB modular digital multimeter to perform the various measurement functions either through the software front panel or by sending SCPI commands remotely via the USB interface.



## Powering Up

Take note of the following when you power up the U2741A.

- The U2741A can only be operated via the USB interface.
- Before you can control the U2741A, you need to install the hardware driver and the IO Libraries Suite 14.2 or higher. Both of these are included when you purchase the U2741A. Refer to the *Agilent USB Modular Products and Systems Quick Start Guide* for the installation procedure.
- On the front panel of the U2741A, there are two LED indicators. Refer to [Chapter 1, “Product Outlook”](#) on page 3.
- Power indicator lights up once the U2741A is powered up. It will blink if there is a system error.
- USB indicator will only blink when there is data exchange activity between the U2741A and the PC.

You can control your U2741A via the AMM for U2741A or via SCPI commands sent through the USB interface from your own application programs.

The Agilent U2741A complies with the syntax rules and conventions of SCPI commands.

You can determine the U2741A's SCPI language version by sending the `SYSTem:VERSion?` command from the remote interface.

For a complete discussion of U2741A's SCPI syntax, refer to the *Agilent U2741A Programmer's Reference*.

## Making Measurements

The following pages show how to make measurement connections and how to select measurement functions from the front panel for each of the measurement functions.

### Measuring DC Voltage

The DC voltage measurement function has the following features:

- Five ranges to select: 100 mV, 1 V, 10 V, 100 V, and 300 V or, auto-range.
- Input impedance is 10 M $\Omega$  for all ranges (typical).
- Input protection is 300 V on all ranges (HI terminal).

Make the connection as shown below.

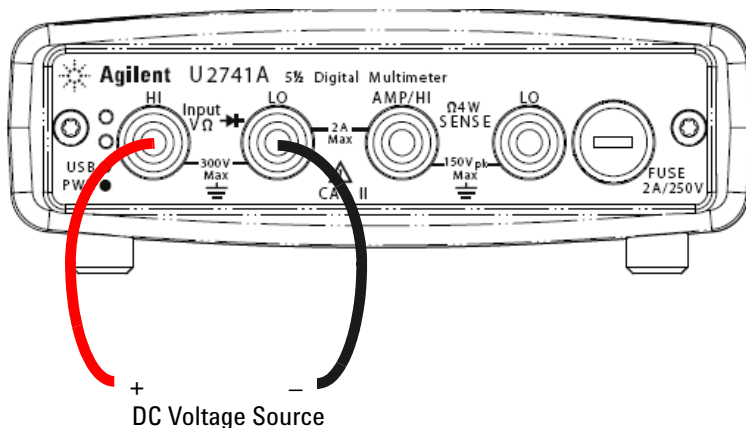

### **Agilent Measurement Manager operation**

Select the **DCV** function and desired range. A suitable range should be selected to give the best measurement resolution. The reading is displayed and updated continuously.

### **SCPI commands**

The following example shows how to make a DC voltage measurement using SCPI commands.

```
MEASure[:VOLTage]:DC?
```



## Measuring AC Voltage

The AC voltage measurement function has the following features:

- Five ranges to select: 100 mVrms, 1 Vrms, 10 Vrms, 100 Vrms, and 250 Vrms or, auto-range.
- Measures the AC-coupled true rms.
- Measures within the stipulated accuracy at a crest factor of a maximum of 5:1 (full scale).
- Input impedance is  $1\text{ M}\Omega \pm 2\%$  in parallel with less than 120 pF capacitance on all ranges.

Make the connection as shown below.

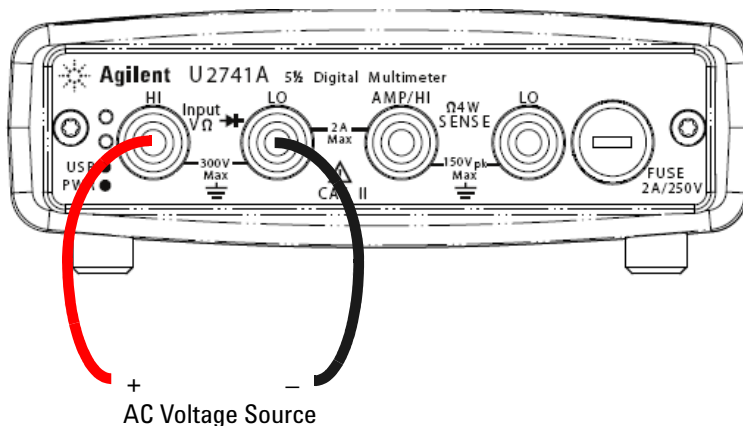

### Agilent Measurement Manager operation

Select the **ACV** function and desired range. A suitable range should be selected to give the best measurement resolution. The reading is displayed and updated continuously.

### SCPI commands

The following example shows how to make an AC voltage measurement using SCPI commands.

```
MEASure[:VOLTage]:AC?
```

### Measuring DC Current

The DC current measurement function has the following features:

- Three ranges to select: 10 mA, 100 mA, 1 A and 2 A or, auto-range.
- Input protection fuse is 2 A, voltage rating 250 V on all ranges.

Make the connection as shown below.

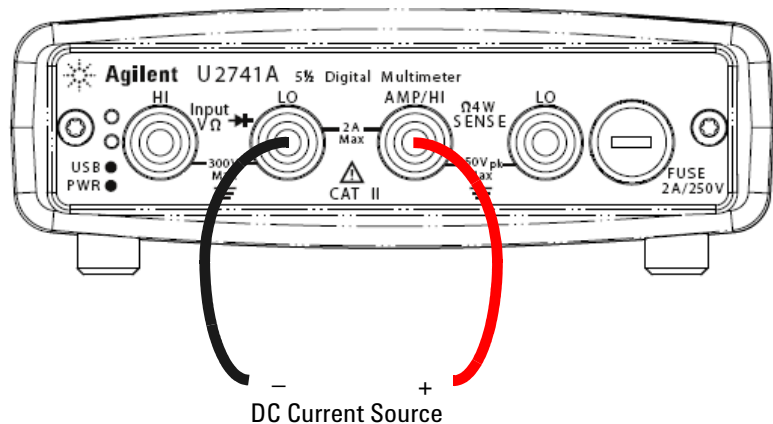

### Agilent Measurement Manager operation

Select the **DCI** function and desired range. A suitable range should be selected to give the best measurement resolution. The reading is displayed and updated continuously.

## SCPI commands

The following example shows how to make a DC current measurement using SCPI commands.

```
MEASure:CURRent[:DC]?
```

## Measuring AC Current

The AC current measurement function has the following features:

- Three ranges to select: 10 mA, 100 mA, 1 A and 2 A or, auto-range.
- Measures true rms value.

Make the connection as shown below.

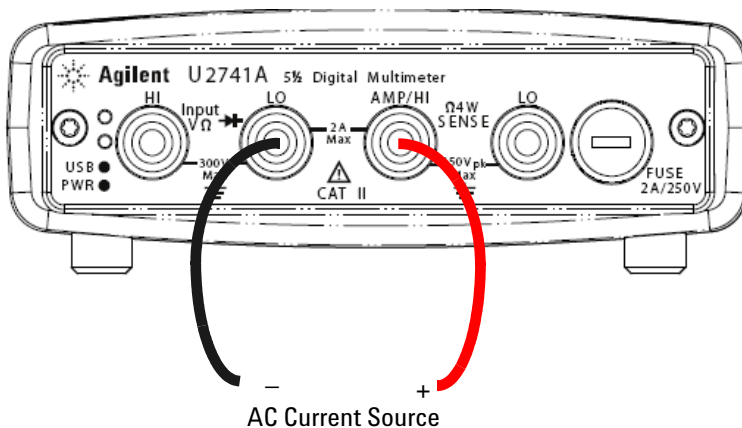

## Agilent Measurement Manager operation

Select the **ACI** function and desired range. A suitable range should be selected to give the best measurement resolution. The reading is displayed and updated continuously.

### SCPI commands

The following example shows how to make an AC current measurement using SCPI commands.

```
MEASure:CURRent:AC?
```

## Measuring Resistance

The resistance measurement function has the following features:

- Seven ranges to select: 100  $\Omega$ , 1 k $\Omega$ , 10 k $\Omega$ , 100 k $\Omega$ , 1 M $\Omega$ , 10 M $\Omega$ , and 100 M $\Omega$  or, auto-range.
- Supports two-wire and four-wire resistance measurement.
- Open circuit voltage is limited to less than 4.5 V on all ranges.

The figure below shows a two-wire resistance measurement connection.

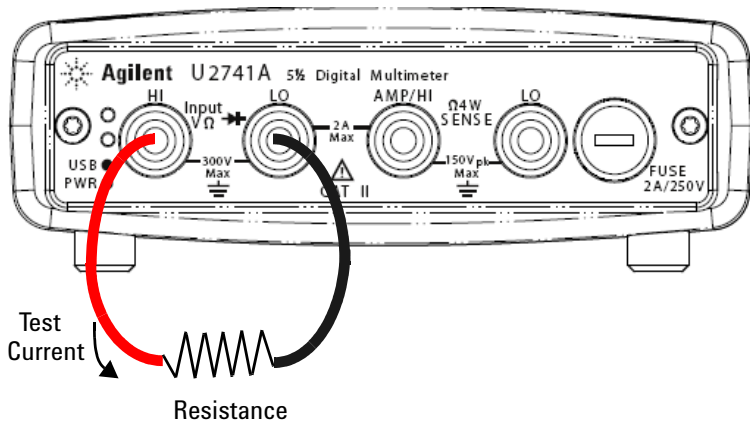

The following figure shows a four-wire resistance measurement connection.

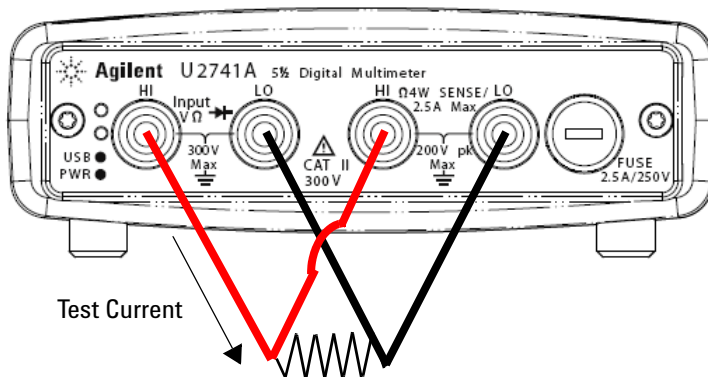

### Agilent Measurement Manager operation

Select the **2-Wired  $\Omega$**  function and desired range for two-wire resistance measurement. Select the **4-Wired  $\Omega$**  function and desired range for four-wire resistance measurement. A suitable range should be selected to give the best measurement resolution. The reading is displayed and updated continuously.

### SCPI commands

The following example shows how to make a resistance measurement using SCPI commands.

Two-wire : MEASure:RESistance?

Four-wire : MEASure:FRESistance?

## Measuring Frequency

The frequency measurement function has the following features:

- Range is based on the amplitude of the signal.
- Employs a reciprocal counting technique as the measurement method.
- Gate time can be set at 0.1 second or 1 second of the input signal.

Make the connection as shown below.

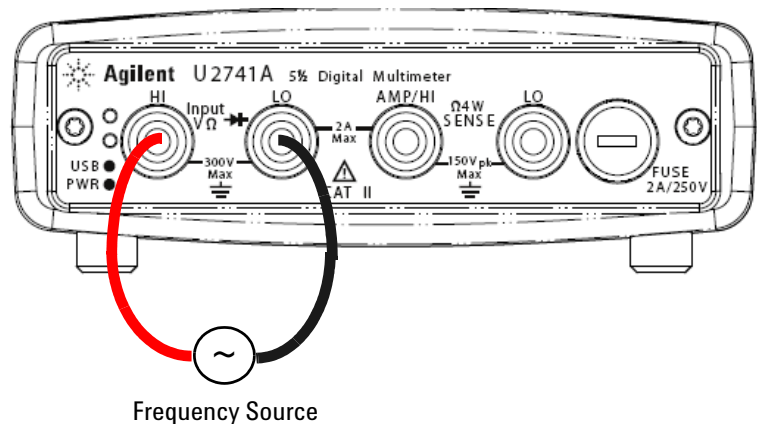

### Agilent Measurement Manager operation

Select the **Freq** function and desired range. The reading is displayed and updated continuously.

### SCPI commands

The following example shows how to make a frequency measurement using SCPI commands.

```
MEASure:FREQuency?
```

## Testing Continuity

The continuity testing function has the following features:

- Uses a 1 mA  $\pm$  0.2% constant current source.
- Open circuit voltage is limited to less than 4.5 V for all ranges.
- Continuity threshold is fixed at 10  $\Omega$
- Response time is 60 samples/second.

Make the connection as shown below.

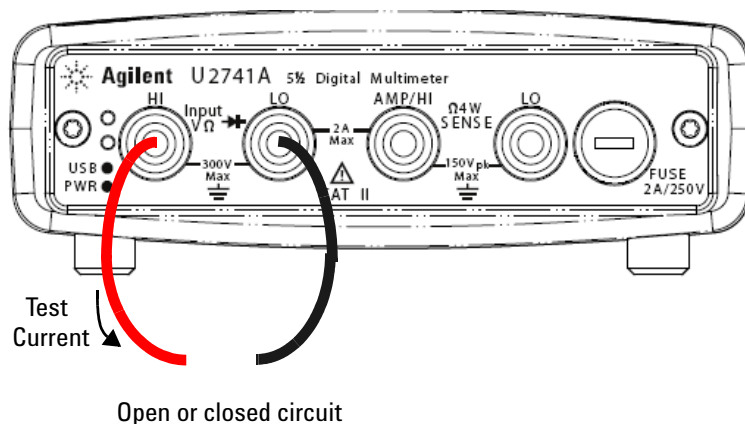

Open or closed circuit

### Agilent Measurement Manager operation

Select the **Cont-)))** function. The reading is displayed and updated continuously.

### SCPI commands

The following example shows how to make a Continuity Test measurement using SCPI commands.

```
MEASure:CONTinuity?
```

## Testing Diodes

The diode testing function has the following features:

- Uses a 1 mA  $\pm$  0.2% constant current source.
- Open circuit voltage is limited to less than 4.5 V for all ranges.
- Response time is 60 samples/second.

Make the connection as shown below.

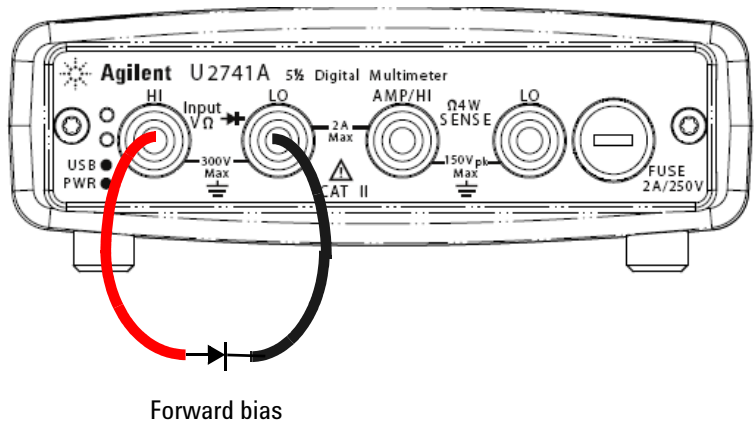

### Agilent Measurement Manager operation

Select the **Diode**  function. The reading is displayed and updated continuously.

### SCPI commands

The following example shows how to make a Diode Test measurement using SCPI commands.

```
MEASure:DIODE?
```



## Measuring Temperature

The temperature measurement function has the following features:

- The measurement range is dependant on the type of temperature sensor used. For the specification details of the temperature sensors, please refer to [Table 4-8](#) on page 71.
- Measurements are in auto-range for 5 k $\Omega$  thermistor probe.
- Supports the thermistor.

Make the connection as shown below.

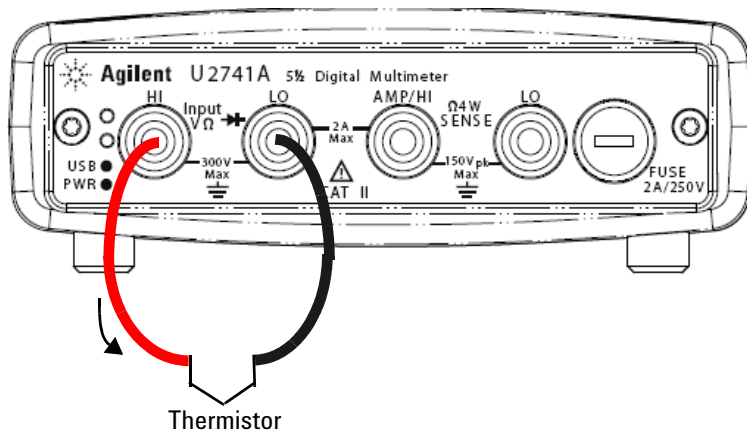

### Agilent Measurement Manager operation

Select the **Temp** function and the type of thermistor used. The reading is displayed and updated continuously.

### SCPI commands

The following example shows how to make a temperature measurement using SCPI commands.

```
MEASure:TEMPerature? THER //Used for thermistor  
                           measurement
```

## Restoring Instrument State

The U2741A automatically saves the last configuration whenever a power-down event occurs and restores to the last power-down state when you turn on the instrument.

### Autozero

When autozero is *enabled*, the digital multimeter internally disconnects the input signal following each measurement, and takes a *zero reading*. It then subtracts the zero reading from the preceding reading. This prevents offset voltages present on the digital multimeter's input circuitry from affecting measurement accuracy.

*This is applicable to dc voltage, dc current, two-wire ohms and temperature measurements only.*

### SCPI Commands

The following commands are used to set the autozero:

```
VOLTage:ZERO:AUTO {OFF|ON}
```

```
CURRent:ZERO:AUTO {OFF|ON}
```

```
RESistance:ZERO:AUTO {OFF|ON}
```

```
TEMPerature:ZERO:AUTO {OFF|ON}
```

# Ranging

You can let the digital multimeter automatically select the range using *auto range* or you can select a fixed range using *manual range*. Autoranging is convenient because the digital multimeter automatically selects the appropriate range for each measurement. However, you can use manual range for faster measurements since the digital multimeter does not have to determine which range to use for each measurement.

- Autorange thresholds:

Down range at: <10% of range

Up range at: >120% of range

- For manual range, if the input signal is greater than the present range can measure, the digital multimeter gives an overload indication: "9.9E+37" from the remote interface. For auto range, the digital multimeter will give an overload indication "9.9E+37" if the input signal is greater than the highest measurement range.
- The range is fixed for continuity tests (1 k $\Omega$  range) and diode tests (1 VDC range with 1 mA current source output).

## SCPI Commands

You can set the range using any of the following commands.

```
CONFigure:<function> {<range>|MIN|MAX|AUTO},  
{<resolution>|MIN|MAX|DEF}
```

```
MEASure:<function>? {<range>|MIN|MAX|AUTO},  
{<resolution>|MIN|MAX|DEF}
```

```
<function>:RANGE {<range>|MINimum|MAXimum|AUTO}
```

```
<function>:RANGE:AUTO {OFF|ON}
```

## Default Settings

The table below summarizes the U2741A's settings as received from the factory, at power-on or following the \*RST command received over the USB remote interface.

**Table 2-1** Default settings summary

Parameter	Factory Setting	Power-on/Reset State
<b>Measurement Configuration</b>		
Function	DCV	DCV
Range	AUTO	AUTO
Resolution	5.5 digits	5.5 digits
Temperature Unit	°C	User setting
<b>Trigger Operation</b>		
Trigger Source	Auto Trigger	Auto Trigger
<b>System-Related Operation</b>		
Power-Down Recall	Disabled	User Setting
Stored States	0-10 Cleared	No Change
Reading Output Buffer	Cleared	Cleared
Error Queue	Cleared	Cleared
Power-on Status Clear	Enabled	User Setting
Status Registers, Masks & Transition Filter	Cleared	Cleared in power-on status clear enabled
<b>Calibration</b>		
Calibration State	Secured	User Setting
Calibration Value	0	No Change
Calibration String	Cleared	No Change

## Triggering the U2741A

At power-up, the default trigger source is immediate. To make a measurement, the following steps are to be followed:

- Configure the U2741A by selecting the function, range, resolution, and so on.
- Specify the digital multimeter's trigger source. You can select software bus trigger or an immediate internal trigger (default trigger source).
- Ensure that the U2741A is in wait-for-trigger state to accept a trigger from the specified source.

### Immediate triggering

In the immediate trigger mode, the trigger signal is always present. When you place the U2741A in the wait-for-trigger state, the trigger is issued immediately. This is the default trigger source.

### SCPI command

The following command sets the trigger source to immediate:

```
TRIGger:SOURce IMMEDIATE
```

### Software bus triggering

The bus trigger mode is initiated by sending a bus trigger command, after selecting BUS as the trigger source.

### SCPI command

The following command sets the trigger source to bus:

```
TRIGger:SOURce BUS
```

The MEASure? and READ? command overwrites the BUS trigger and triggers the digital multimeter and returns a measurement.

The `INITiate` command changes the state of the triggering to wait-for-trigger state. Measurements will begin when the specified trigger conditions are satisfied.

### Star Triggering

The star trigger can only be applied when the U2741A is connected into the U2781A modular instrument chassis. It is used to trigger multiple modular units in the chassis.

### SCPI command

```
TRIGger:SOURce STRG
```

### Synchronization Status

This is to configure the synchronization of multiple units of U2741A (slave only) when used in the U2781A modular instrument chassis. Only one master can be assigned at a time.

### SCPI command

```
CONFigure:SSI {NONE|SLAVE}
```

Refer to the *Agilent U2741A Programmer's Reference* for complete description and syntax for these commands.

## System-Related Operation

This section provides information on system-related topics such as performing a self-calibration routine and reading error conditions.

### Error Conditions

A record of up to 20 errors can be stored in the U2741A's error queue. Refer to the programming guide for more information on the error messages.

#### **Agilent Measurement Manager Operation**

A message box will appear once an error occurs while operating the U2741A using the AMM.



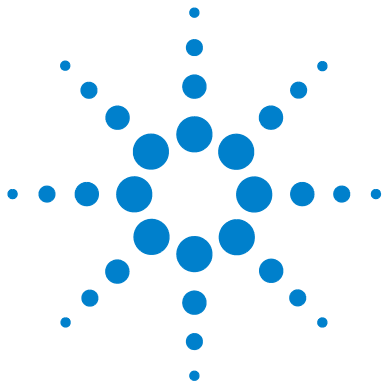

## 3 Measurement Tutorial

DC Measurement Considerations	48
Noise Rejection	49
Resistance Measurement Considerations	52
AC Measurements	55
Other Primary Measurement Functions	58
Frequency Measurement Errors	58
DC Current Measurements	58
Other Sources of Measurement Error	60

The Agilent U2741A is capable of making accurate measurements but in order to achieve the best accuracy, you must take the necessary steps to eliminate potential measurement errors. This chapter describes common errors found in measurements and gives suggestions to help you avoid or minimize these errors.



## DC Measurement Considerations

### Thermal EMF errors

Thermoelectric voltages are the most common source of error in low-level DC voltage measurements. Thermoelectric voltages are generated when you make circuit connections using dissimilar metals at different temperatures.

Each metal-to-metal junction forms a thermocouple, which generates a voltage proportional to the junction temperature. You should take the necessary precautions to minimize thermocouple voltages and temperature variations in low-level voltage measurements. The best connections are formed using copper-to-copper crimped connections, as the digital multimeter's input terminals are copper alloy. The table below shows common thermoelectric voltages for connections between dissimilar metals.

**Table 3-1** Thermoelectric voltage for dissimilar metals connections

Copper to -	Approx. mV / °C	Copper to -	Approx. mV / °C
Cadmium-Tin Solder	0.2	Aluminum	5
Copper	<0.3	Tin-Lead Solder	5
Gold	0.5	Kovar or Alloy 42	40
Silver	0.5	Silicon	500
Brass	3	Copper-Oxide	1000
Beryllium	5		

## Noise Rejection

### Rejecting power-line noise voltages

An important property of integrating analog-to-digital (A/D) converters is their ability to reject power-line related noise that is present on the DC input signals. This is called normal mode noise rejection, or NMR. The digital multimeter achieves NMR by measuring the average DC input by "integrating" it over an integral number of power line cycles.

### Common mode rejection (CMR)

Ideally, a digital multimeter is completely isolated from earth-referenced circuits. However, there is a finite resistance between the digital multimeter's input LO terminal and earth ground, as shown below. This can cause errors when measuring low voltages that are floating in relative to earth ground.

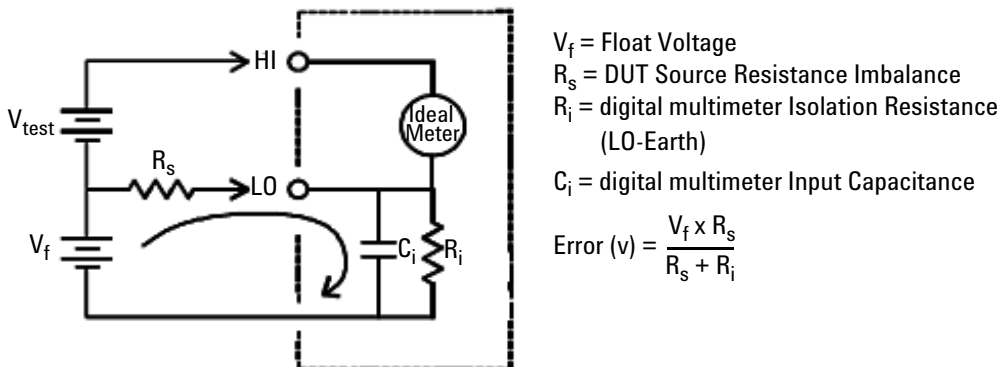

**Figure 3-1** Common mode source error

#### **Noise caused by magnetic loops**

If you are making measurements near magnetic fields, it is a good practice to avoid inducing voltages in the measurement connections. Conductor carrying high current is one common source of magnetic field. You can use twisted-pair cable connections to the digital multimeter to reduce the noise pickup loop area, or place the test leads as close together as possible. Loose or vibrating test leads will also induce error voltages. Tie test leads securely when operating near magnetic fields. Whenever possible, use magnetic shielding materials or increase the distance from magnetic sources to minimize this error.

#### **Noise caused by ground loops**

When measuring voltages in circuits where the digital multimeter and the device under test are both referenced to a common earth ground, a ground loop is formed. As shown in [Figure 3-2](#), any voltage difference between the two ground reference points ( $V_{\text{ground}}$ ) will cause a current to flow through the measurement leads. This gives rise to noise and offset voltage (usually power-line related), which are added to the measured voltage.

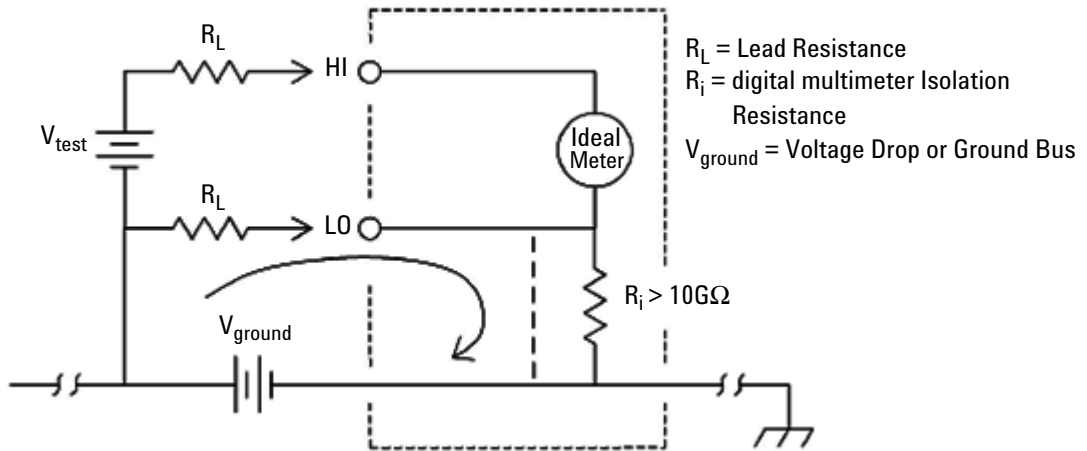

**Figure 3-2** Ground loop induced error

The best way to eliminate ground loops is to isolate the digital multimeter from earth by not grounding the input terminals. If the digital multimeter must be earth-referenced, connect it and the device under test to the same common ground point. Also connect the digital multimeter and device under test to the same electrical outlet whenever possible.

## Resistance Measurement Considerations

When measuring resistance, the test current flows from the input HI terminal through the resistor being measured. The voltage drop across the resistor being measured is sensed internally in the digital multimeter. Therefore, the test lead resistance is also measured.

The errors mentioned earlier in this chapter for DC voltage measurements also apply to resistance measurements. Additional error sources unique to resistance measurements are discussed here.

### Resistance Measurements

The Agilent U2741A offers two methods for measuring resistance:

*2-wire* and *4-wire* ohms. For both methods, the test current flows from the input HI terminal and then through the resistor being measured. For 2-wire ohms, the voltage drop across the resistor being measured is sensed internal to the digital multimeter. Therefore, test lead resistance is also measured. For 4-wire ohms, separate “sense” connections are required. Since no current flows in the sense leads, the resistance in these leads does not give a measurement error.

*The errors mentioned earlier in this chapter for dc voltage measurements also apply to resistance measurements. Additional error sources unique to resistance measurements are discussed on the following pages.*

### 4-Wire Ohms Measurements

The 4-wire ohms method provides the most accurate way to measure small resistances. Test lead resistances and contact resistances are automatically reduced using this method. Four-wire ohms is often used in automated test applications where long cable lengths, numerous connections, or switches exist between the digital multimeter and the device-under-test. The recommended connections for 4-wire ohms measurements are shown below.

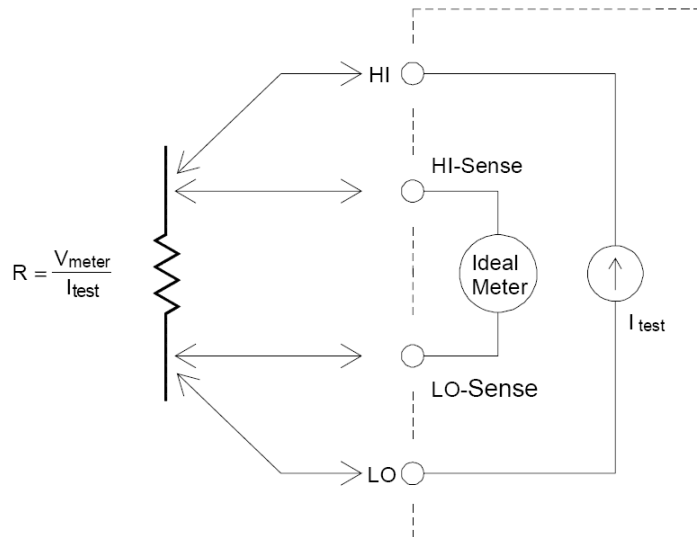

### Removing test lead resistance errors

To eliminate offset errors associated with the test lead resistance in 2-wire ohms measurements, follow the steps below.

- 6** Short the tips of the test leads. The reading is the test lead resistance.
- 7** Click Null. The digital multimeter stores the test lead resistance as the 2-wire resistance null value and the digital multimeter will subtract this value from the value of subsequent measurements.

### Minimizing power dissipation effects

When measuring resistors designed for temperature measurements (or other resistive devices with large temperature coefficients), be aware that the digital multimeter will dissipate some power in the device under test.

If power dissipation is a problem, you should select the digital multimeter's next higher measurement range to reduce the errors to acceptable levels. The following table shows several examples:

**Table 3-2** Power dissipation for various resistance ranges

Range	Test current	DUT power at full scale
100 $\Omega$	1 mA	100 mW
1 k $\Omega$	0.83 mA	689 mW
10 k $\Omega$	100 mA	100 mW
100 k $\Omega$	10 mA	10 mW
1 M $\Omega$	900 nA	810 nW
10 M $\Omega$	205 nA	420 nW
100 M $\Omega$	205 nA    10 M $\Omega$	35 nW

### Errors in high resistance measurements

When you are measuring large resistances, significant errors can occur due to insulation resistance and surface cleanliness. You should take the necessary precautions to maintain a "clean" high-resistance system. Test leads and fixtures are susceptible to leakage due to moisture absorption in insulating materials and "dirty" surface films. Nylon and PVC are relatively poor insulators ( $10^9 \Omega$ ) when compared to Polytetrafluoroethylene (PTFE) insulators ( $10^{13} \Omega$ ). Leakage from nylon or PVC insulators can easily contribute a 0.1% error when measuring a 1 M $\Omega$  resistance in humid conditions.



## AC Measurements



### True RMS AC measurements

True RMS responding digital multimeter, like the U2741A, measure the "heating" potential of an applied voltage. Power dissipated in a resistor is proportional to the square of the voltage waveform. This digital multimeter accurately measures true RMS voltage or current, as long as the wave shape contains negligible energy above the instrument's effective bandwidth.

#### NOTE

The U2741A uses the same techniques to measure true RMS voltage and true RMS current.

**Table 3-3** Waveform shapes and their parameters

Waveform shape	Crest factor (CF)	AC RMS	AC+DC RMS
	$\sqrt{2}$	$\frac{V}{\sqrt{2}}$	$\frac{V}{\sqrt{2}}$
	$\sqrt{3}$	$\frac{V}{\sqrt{3}}$	$\frac{V}{\sqrt{3}}$

**Table 3-3** Waveform shapes and their parameters

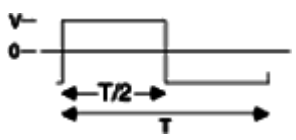
Waveform shape	Crest factor (CF)	AC RMS	AC+DC RMS
	$\frac{T}{\sqrt{t_p}}$	$\frac{V}{CF} \times \sqrt{1 - \left(\frac{1}{CF}\right)^2}$	$\frac{V}{CF}$
	1	$V$	$V$

The digital multimeter's AC voltage and AC current functions measure the AC-coupled true RMS value, where only the "heating value" of only the AC components of the input waveform is measured while the DC component is rejected. As seen in the figure above; for sine waves, triangular waves, and square waves, the AC-coupled and AC+DC values are equal, since these waveforms do not contain a DC offset. However, for non-symmetrical waveforms, such as pulse trains, there is a DC voltage content, which is rejected by Agilent's AC-coupled true RMS measurements. This can provide a significant benefit. An AC-coupled true RMS measurement is desirable when you are measuring small AC signals in the presence of large DC offsets.

A good example is measuring AC ripples that are present in DC power supplies. There are situations, however, where you might want to know the AC+DC true RMS value. You can determine this value by combining results from DC and AC measurements, as shown below (Equation ):

$$(AC + DC)_{TrueRMS} = \sqrt{AC^2 + DC^2} \tag{1}$$

For the best AC noise rejection, you should perform the DC measurement at 20 NPLC.

### **True RMS accuracy and high-frequency signal content**

A common misconception is that “since an AC digital multimeter is true RMS, its sine wave accuracy specifications apply to all waveforms.” Actually, the shape of the input signal can dramatically affect the measurement accuracy especially when that input signal contains high-frequency components which exceed the instrument's bandwidth.

## Other Primary Measurement Functions

### Frequency Measurement Errors

The U2741A uses a reciprocal counting technique to measure frequency. This method generates a constant measurement resolution for any input frequency. All frequency counters are susceptible to errors when measuring low-voltage, low-frequency signals. The effects of both internal noise and external noise pickup are critical when measuring "slow" signals. The error is inversely proportional to frequency. Measurement errors also occur if you attempt to measure the frequency of an input following a DC offset voltage change and therefore, you must allow the digital multimeter's input to fully settle before making frequency measurements.

### DC Current Measurements

When you connect the digital multimeter in series with a test circuit to measure current, a measurement error is introduced. The error is caused by the digital multimeter's series burden voltage. A voltage is developed across the wiring resistance and current shunt resistance of the digital multimeter, as shown below.

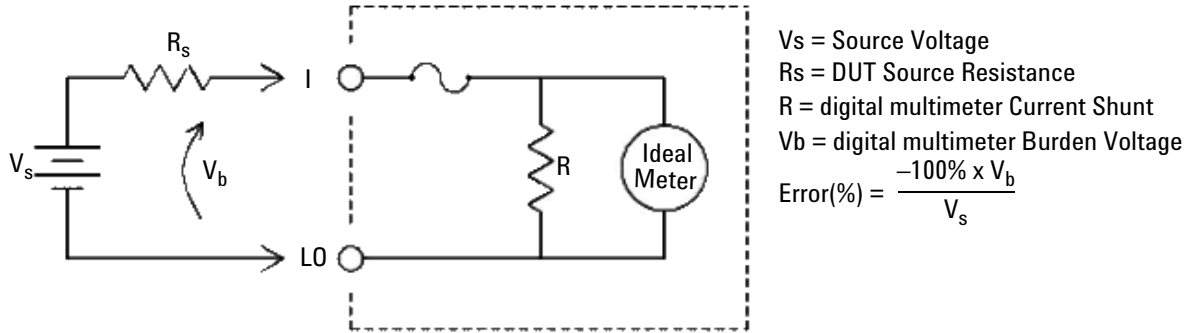

**Figure 3-3** Burden voltage in current measurement

**NOTE**

When used in the Agilent USB Modular Instrument Chassis, it is recommended to use the null function of the U2741A to nullify any offset. A 30-minute warm-up is required as stated in the DC specification.

## Other Sources of Measurement Error

### Loading errors (AC volts)

In the AC voltage function, the input of the digital multimeter appears as a 1 MΩ resistance in parallel with 100 pF of capacitance. The cabling that you use to connect signals to the digital multimeter also adds capacitance and loading.

For low frequencies, the loading error is (Equation 2):

$$Error(\%) = \frac{-100 \times R_s}{R_s + 1 \text{ M}\Omega} \quad (2)$$

At high frequencies, the additional loading error is (Equation 3):

$$Error(\%) = 100 \times \left[ \frac{1}{\sqrt{1 + (2\pi \times F \times R_s \times C_{in})^2}} - 1 \right] \quad (3)$$

$R_s$  = Source resistance

$F$  = Input frequency

$C_{in}$  = Input capacitance (100 pF) plus cable capacitance

### Measurements below full scale

You can make the most accurate AC measurements when the digital multimeter is at or near the full scale of the selected range. Autoranging occurs at 10% (down-range) and 120% (up-range) of full scale. This enables you to measure some inputs at full scale on one range and 10% of full scale on the next higher range. In general, the accuracy is better on the lower range; for the highest accuracy, select the lowest manual range possible for the measurement.

### **High-voltage self-heating errors**

If you apply more than 300 Vrms, self-heating occurs in the digital multimeter's internal signal-conditioning components. These errors are included in the digital multimeter's specifications.

Temperature changes inside the digital multimeter due to self-heating may cause additional error on other AC voltage ranges.

### **AC current measurement errors (burden voltage)**

Burden voltage errors, which apply to DC current, also apply to AC current measurements. However, the burden voltage for AC current is larger due to the digital multimeter's series inductance and your measurement connections. The burden voltage increases as the input frequency increases. Some circuits may oscillate when performing current measurements due to the digital multimeter's series inductance and your measurement connections.

### **Low-level measurement errors**

When measuring AC voltages less than 100 mV, be aware that these measurements are especially susceptible to errors introduced by extraneous noise sources. An exposed test lead acts as an antenna and a properly functioning digital multimeter will measure the signals received. The entire measurement path, including the power line, acts as a loop antenna. Circulating currents in the loop create error voltages across any impedance in series with the digital multimeter's input. For this reason, you should apply low-level AC voltages to the digital multimeter through shielded cables. You should connect the shield to the input LO terminal.

Make sure the digital multimeter and the AC source are connected to the same electrical outlet whenever possible. You should also minimize the area of any ground loops that cannot be avoided. A high-impedance source is more susceptible to noise pickup than a low-impedance source. You can reduce the high-frequency impedance of a source by placing a capacitor in parallel with the digital multimeter's input terminals. You may have to experiment to determine the correct capacitor value for your application.

Most extraneous noise is not correlated with the input signal. You can determine the error as shown below (Equation 4):

$$\text{Voltage Measured} = \sqrt{V_{in}^2 + \text{Noise}^2} \quad (4)$$

Correlated noise, while rare, is especially detrimental. Correlated noise always adds directly to the input signal. Measuring a low-level signal with the same frequency as the local power line is a common situation that is prone to this error.





## 4 Characteristics and Specifications

Product Characteristics 65

Product Specifications 67

This chapter describes the U2741A product characteristics and operating specifications.



When using the multimeter in an environment where electromagnetic interference or significant electrostatic charge is present, measurement accuracy may be reduced.

### NOTE

- The voltage measurement probes are not shielded and can act as antennas allowing electromagnetic interference to be added to the signal being measured.
  - Electrostatic discharges of 4000 V or greater may cause the multimeter to temporarily stop responding, resulting in a lost or erroneous reading.
-

## Product Characteristics

<b>REMOTE INTERFACE</b> <sup>[1]</sup>	<ul style="list-style-type: none"> <li>• Hi-Speed USB 2.0</li> <li>• USBTMC 488.2 Class device<sup>[2]</sup> <sup>[5]</sup></li> </ul>
<b>POWER CONSUMPTION</b>	<ul style="list-style-type: none"> <li>• +12 VDC, 2 A maximum</li> <li>• Isolated ELV power source</li> </ul>
<b>OPERATING ENVIRONMENT</b>	<ul style="list-style-type: none"> <li>• One year specifications full accuracy from 18 °C to 28 °C at 50% RH</li> <li>• Altitude up to 2000 meters</li> <li>• Pollution degree 2</li> <li>• For indoor use only</li> </ul>
<b>STORAGE COMPLIANCE</b>	<ul style="list-style-type: none"> <li>• –20 °C to +70 °C</li> <li>• Relative humidity at 5% to 90% RH (non-condensing)</li> </ul>
<b>SAFETY COMPLIANCE</b>	Certified with: <ul style="list-style-type: none"> <li>• IEC 61010-1:2001/EN61010-1:2001 (2nd Edition)</li> <li>• Canada: CAN/CSA-C22.2 No. 61010-1-04</li> <li>• USA: ANSI/UL 61010-1:2004</li> </ul>
<b>MEASUREMENT COMPLIANCE</b>	CAT II 300 V Over-voltage Protection
<b>EMC COMPLIANCE</b>	<ul style="list-style-type: none"> <li>• IEC 61326-2002/EN61326:1997+A1:1998+A2:2001+A3:2003</li> <li>• Canada: ICES-001:2004</li> <li>• Australia/New Zealand: AS/NZS CISPR11:2004</li> </ul>
<b>COMMON MODE REJECTION RATIO (CMRR)</b>	<ul style="list-style-type: none"> <li>• DC CMRR &gt;120 dB with 1k unbalanced load</li> <li>• AC CMRR &gt;70 dB at 50/60 Hz ±0.1% with 1k unbalanced load</li> </ul>
<b>NORMAL MODE REJECTION RATIO (NMRR)</b>	<ul style="list-style-type: none"> <li>• &gt;60 dB at 50/60 Hz ±0.1%<sup>[3]</sup></li> <li>• &gt;0 dB at 50/60 Hz ±0.1%<sup>[4]</sup></li> </ul>
<b>SHOCK AND VIBRATION</b>	Tested to IEC/EN 60068-2
<b>I/O CONNECTOR</b>	Four banana socket terminals
<b>DIMENSIONS (W × D × H)</b>	<ul style="list-style-type: none"> <li>• 105.00 mm x 175.00 mm x 11.50 mm (without bumpers)</li> <li>• 117.00 mm x 180.00 mm x 41.00 mm (with bumpers)</li> </ul>
<b>WEIGHT</b>	<ul style="list-style-type: none"> <li>• 451 g (without bumpers)</li> <li>• 509 g (with bumpers)</li> </ul>
<b>WARRANTY</b>	<ul style="list-style-type: none"> <li>• Please refer to <a href="http://www.agilent.com/go/warranty_terms">http://www.agilent.com/go/warranty_terms</a> <ul style="list-style-type: none"> <li>• 3 years for the product</li> <li>• 3 months for the product's standard accessories, unless otherwise specified</li> </ul> </li> <li>• Please take note that for the product, the warranty does not cover:                             <ul style="list-style-type: none"> <li>• Damage from contamination</li> <li>• Normal wear and tear of mechanical components</li> <li>• Manuals</li> </ul> </li> </ul>

## 4 Characteristics and Specifications

<b>CALIBRATION</b>	Calibration interval of one year is highly recommended
<b>Measurement Category</b>	The U2741A USB modular digital multimeter is intended to be used for measurement in Measurement Category II, 300 V.
<b>Measurement Category Definition</b>	<p>Measurement CAT I is for measurements performed on circuits not directly connected to MAINS. Examples are measurements on circuits not derived from MAINS, and specially protected (internal) mains- derived circuits.</p> <p>Measurement CAT II are measurements performed on circuits directly connected to the low voltage installation. Examples are measurements on household appliances, portable tools, and similar equipment.</p> <p>Measurement CAT III are measurements performed in the building installation. Examples are measurements on distribution boards, circuit- breakers, wiring, including cables, bus- bars, junction boxes, switches, socket outlets in the fixed installation, and equipment for industrial use, and some other equipment including stationary motors with permanent connection to the fixed installation.</p> <p>Measurement CAT IV are measurements performed at the source of the low- voltage installation. Examples are electricity meters and measurements on primary over current protection devices and ripple control units.</p>

[1] For remote connections using Agilent E5813A, refer to [Chapter 1](#).

[2] Compatible with Microsoft Windows operating systems only.

[3] Applicable for NPLC >1

[4] Applicable for NPLC 0.2 and 0.02

[5] Requires a direct USB connection to the PC so the appropriate driver can be installed in the USB modular instrument or USB DAQ module

# Product Specifications

## DC specifications <sup>[1]</sup>

**Table 4-1** DC accuracy

Function	Range	Input impedance	Test current /Burden voltage, shunt resistance	Accuracy ( $\pm$ % of reading + % of range)	Temperature Coefficient 0 °C to 18 °C 28 °C to 55 °C
Voltage <sup>[2]</sup>	100.000 mV	10 M $\Omega$	–	0.015 + 0.008	0.002 + 0.0008
	1.00000 V	10 M $\Omega$	–	0.015 + 0.005	0.001 + 0.0005
	10.0000 V	10 M $\Omega$	–	0.018 + 0.005	0.002 + 0.0005
	100.000 V	10 M $\Omega$	–	0.018 + 0.005	0.002 + 0.0005
	300.000 V	10 M $\Omega$	–	0.018 + 0.005	0.0015 + 0.0005
Current <sup>[3]</sup>	10.0000 mA	–	<0.2 V, 10 $\Omega$	0.06 + 0.015	0.005 + 0.0025
	100.000 mA	–	<0.2 V, 1 $\Omega$	0.06 + 0.005	0.008 + 0.002
	1.00000 A	–	<0.3 V, 0.1 $\Omega$	0.15 + 0.007	0.005 + 0.002
	2.0000 A	–	<0.8 V, 0.1 $\Omega$	0.15 + 0.007	0.005 + 0.002
Resistance <sup>[4]</sup>	100.000 $\Omega$	–	1.0 mA	0.03 + 0.008	0.006 + 0.0008
	1.00000 k $\Omega$	–	1.0 mA	0.03 + 0.005	0.006 + 0.0005
	10.0000 k $\Omega$	–	100 $\mu$ A	0.03 + 0.005	0.006 + 0.0005
	100.000 k $\Omega$	–	10.0 $\mu$ A	0.03 + 0.005	0.006 + 0.0005
	1.00000 M $\Omega$	–	1 $\mu$ A	0.06 + 0.005	0.01 + 0.0005
	10.0000 M $\Omega$	–	225 nA	0.25 + 0.005	0.025 + 0.0005
	100.000 M $\Omega$	–	225 nA	2.0 + 0.005	0.3 + 0.0005
Diode test <sup>[5]</sup>	1.0000 V	–	1.00 mA	0.015 + 0.03	0.005 + 0.0005
Continuity Test <sup>[6]</sup>	1.0000 k $\Omega$	–	1.00 mA	0.05 + 0.03	0.005 + 0.0005

## 4 Characteristics and Specifications

<sup>[1]</sup> Specifications are based on 30 minutes warm-up time, NPLC 20 resolution, and calibration temperature 18 °C to 28 °C. For NPLC 0 and 0.025, add 0.01% of range.

<sup>[2]</sup> 120% over range on all ranges except 300 VDC. Input protection up to 300 VDC.

<sup>[3]</sup> Input protected with externally accessible 2 A, 250 V fast blown fuse.

<sup>[4]</sup> Specifications are for 4-wire ohm or 2-wire ohms using null function in AMM software. If without null function in AMM software, add 0.2 Ω additional error. Input protection up to 300 VDC. Specifications apply for NPLC ≥1.

<sup>[5]</sup> Specifications are for the voltage measured at the input terminals only.

<sup>[6]</sup> Continuity threshold is fixed at less than 10 Ω.

### DC current settling considerations

Switching current from >1 A to lower current measurement may cause an additional error approximately 0.3% of reading due to self-heating, and will generally dissipate within a minute.

### AC specifications <sup>[1]</sup>

**Table 4-2** AC accuracy for voltage

Function	Range	Accuracy input (% of reading + % of range) Frequency (Hz)			
		20 ~ 45	45 ~ 10k	10k ~ 30k	30k ~ 100k <sup>[3]</sup>
Voltage <sup>[2]</sup>	100.000 mVrms	1 + 0.1	0.2 + 0.1	1.5 + 0.3	5.0 + 0.3
	1.00000 V	1 + 0.1	0.2 + 0.1	1.0 + 0.1	3.0 + 0.2
	10.0000 V	1 + 0.1	0.3 + 0.1	1.0 + 0.1	3.0 + 0.2
	100.000 V	1 + 0.1	0.3 + 0.1	1.0 + 0.1	3.0 + 0.2
	250.000 V <sup>[4]</sup>	1 + 0.1	0.3 + 0.1	1.0 + 0.1	3.0 + 0.2

<sup>[1]</sup> Specifications are based on 30 minutes warm-up time and calibration temperature 18 °C to 28 °C. In manual range, the settling time is 2.6 seconds while in autorange, the first measurement accuracy is <1%.

<sup>[2]</sup> Specifications are for sine wave inputs more than 5% of range. 120% over range on all ranges except 250 VAC. Maximum crest factor of 5 at full scale. Input impedance is 1 MΩ in parallel with capacitance less than 120 pF, AC couple with up to

300 VDC.

[3] Additional error to be added as frequency more than 30 kHz and signal input less than 10% of range. 30 kHz to 100 kHz: 0.003% of full scale per kHz.

[4] Input signal has to be more than 50 Vrms.

**Table 4-3** Temperature coefficient for voltage

	Range	Frequency (Hz)			
		20 ~ 45	45 ~ 10k	10k ~ 30k	30k ~ 100k
Temperature coefficient	100.000 mVrms, 1.00000 V, 10.0000 V, 100.000 V, 250.000 V	0.02 + 0.02	0.02 + 0.02	0.05 + 0.02	0.1 + 0.02

**Table 4-4** AC accuracy for current <sup>[1]</sup>

Function	Range	Burden voltage/ Current shunt	Accuracy input (% of reading + % of range) Frequency (Hz)		
			20 ~ 45	45 ~ 1k	1k ~ 10k
Current <sup>[2]</sup>	10.0000 mA	<0.2 V, 10 Ω	1.5 + 0.1	0.5 + 0.1	2 + 0.2
	100.000 mA	<0.2 V, 1 Ω	1.5 + 0.1	0.5 + 0.1	2 + 0.2
	1.00000 A	<0.3 V, 0.1 Ω	1.5 + 0.1	0.5 + 0.1	2 + 0.2
	2.0000 A	<0.8 V, 0.1 Ω	1.5 + 0.1	0.5 + 0.1	2 + 0.2

[1] In manual range, the settling time is 2.6 seconds while in autorange, the first measurement accuracy is <1%.

[2] Input protected with externally accessible 2 A, 250 V fast blown fuse.

**Table 4-5** Temperature coefficient for current

	Range	Frequency (Hz)		
		20 ~ 45	45 ~ 10k	10k ~ 30k
Temperature coefficient	10.0000 mA, 100.000 mA, 1.00000 A, 2.0000 A	0.02 + 0.02	0.02 + 0.02	0.02 + 0.02

## 4 Characteristics and Specifications

### Frequency specifications <sup>[1]</sup>

**Table 4-6** Frequency accuracy

Functions	Range	Accuracy (% of reading + % of range)	Minimum Input Frequency	Temperature Coefficient (%)
Frequency	20 to 300 kHz	0.0200 +0.003	1 Hz	0.005

**Table 4-7** Frequency sensitivity for AC voltage

Functions	Input range	Minimum sensitivity (RMS sine wave) Frequency (Hz)	
		20 ~ 100 k	100 ~ 300 k
AC Voltage	100 mV <sup>[2]</sup>	20 mV	20 mV
	1 V	100 mV	120 mV
	10 V	1 V	1.2 V
	100 V	10 V	20 V
	250 V	100 V	120 V

<sup>[1]</sup> Frequency measurement can only be done in auto range mode. Specifications are for 30 minutes warm-up, using 1 second aperture. Measuring method is using reciprocal counting technique with AC coupled input at AC voltage function. Gate time of 0.1second or 1second.

<sup>[2]</sup> Only applicable for square wave measurement.

### Temperature specifications



**Table 4-8** Temperature accuracy

Function	Thermistor type	Range	Accuracy	Temperature Coefficient
Temperature	5 k $\Omega$ thermistor	-80.0 °C to 150.0 °C -112 °F to 302 °F	Probe accuracy + 0.2 °C	0.002 °C

**THIS PAGE HAS BEEN INTENTIONALLY LEFT BLANK.**

# Index

## A

AC accuracy 68, 69  
AC/DC adapter 7  
AC components 56  
AC-coupled 31, 56  
AC current 2, 33, 34, 56, 61  
AC digital multimeter 57  
AC measurements 56, 60  
AC noise rejection 57  
AC ripples 56  
AC signals 56  
AC source 61  
AC voltage 31, 32, 56, 60, 61, 70  
Agilent Measurement Manager 2, 7, 11, 24  
AMM 2, 16, 28, 46, 68

## C

configuration 11, 25, 41  
continuity test 42

## D

DC accuracy 67  
DC component 56  
DC current 2, 32, 33, 41  
DC offset 56, 58  
DC output 16  
DC power 56  
DC Volt 2  
DC voltage 29, 30, 41, 48, 52, 56  
diode test 2, 38, 42, 67

## F

firmware 19, 20  
frequency 36, 57  
function 60, 61, 68, 70, 71

## I

information 8, 15, 24, 46  
input 25, 29, 31, 32, 36, 41, 42, 48, 49, 51, 52, 56, 57, 58, 60, 61, 62, 68, 69, 70  
installation 11, 12, 13, 14, 15, 16, 17, 66  
instrument 12, 13, 21, 22  
interface 2, 7, 12, 27, 28, 42, 43, 65

## M

modular 2, 7, 8, 9, 25  
module 9, 19, 25, 26

## O

output 16

## P

power-down 41  
power-line 49  
power-up 44

## R

requirements 11, 16  
resistance 2, 35, 52, 53, 54, 58, 60  
resistor 52  
resolution 30, 31, 32, 33, 35

## S

SCPI 28, 30, 32, 33, 34, 35, 36, 37, 38, 39  
specifications 8, 57, 61, 63, 64, 65

## T

temperature 48, 68, 71

## V

voltage 16, 32, 34, 37, 38, 41, 48, 49, 50, 52, 55, 58, 61, 64, 66, 68, 70

## W

waveform 55, 56, 57

**THIS PAGE HAS BEEN INTENTIONALLY LEFT BLANK.**

**www.agilent.com**

### **Contact us**

To obtain service, warranty or technical assistance, contact us at the following phone or fax numbers:

United States:

(tel) 800 829 4444 (fax) 800 829 4433

Canada:

(tel) 877 894 4414 (fax) 800 746 4866

China:

(tel) 800 810 0189 (fax) 800 820 2816

Europe:

(tel) 31 20 547 2111

Japan:

(tel) (81) 426 56 7832 (fax) (81) 426 56

7840

Korea:

(tel) (080) 769 0800 (fax) (080) 769 0900

Latin America:

(tel) (305) 269 7500

Taiwan:

(tel) 0800 047 866 (fax) 0800 286 331

Other Asia Pacific Countries:

(tel) (65) 6375 8100 (fax) (65) 6755 0042

Or visit the Agilent World Wide Web at:  
[www.agilent.com/find/assist](http://www.agilent.com/find/assist)

Product specifications and descriptions in this document are subject to change without notice. Always refer to the English version on the Agilent Web site for the latest revision.

© Agilent Technologies, Inc. , 2008–2013

Sixth Edition, August 2, 2013

U2741-90001



**Agilent Technologies**