

Agilent U1177A IR-to-Bluetooth Adapter

Operating Instructions

The Agilent U1177A IR-to-**Bluetooth**¹ adapter is designed for the use of Agilent handheld digital multimeters (DMM) only, where it allows **Bluetooth** communication between the meter and PC. The U1177A is powered by two AAA batteries, is able to operate about 30 hours (with new alkaline batteries), and provides up to 10-metres connectivity solution.

Front View LED Indicator and Slide Switch

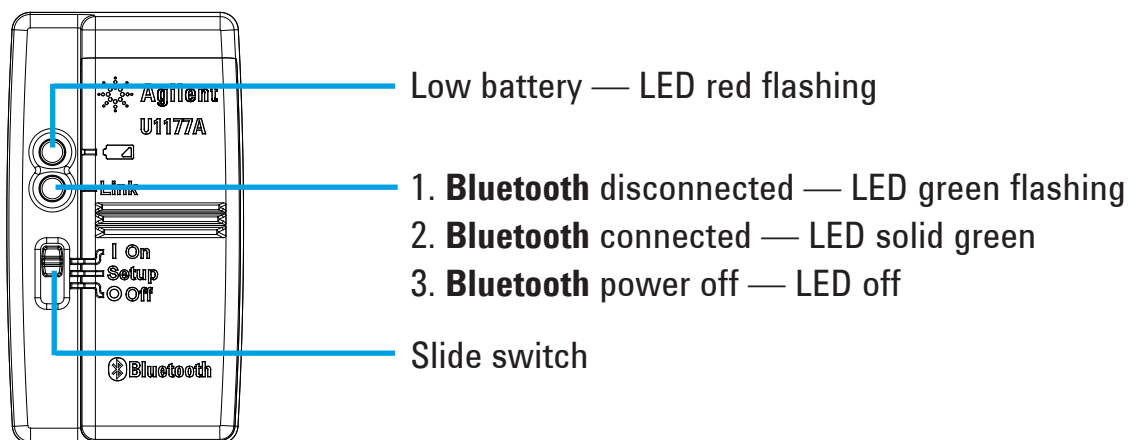

Standard Shipped Items Checklist

The following items are included when you make a purchase:

- U1177A IR-to-**Bluetooth** adapter
- Two 1.5 V AAA batteries
- Operating Instructions (this sheet)

Assistance

For technical assistance, contact your nearest Agilent Sales Office or visit the Agilent website at www.agilent.com/find/assist for further information.

¹ The **Bluetooth**[®] word mark and logos are registered trademark owned by **Bluetooth** SIG, Inc and any use of such marks by Agilent is under license. Other trademark and trade names are those of their respective owners.



Agilent Technologies

Product Characteristics

OPERATING ENVIRONMENT: Operating temperature from –20 °C to 55 °C

STORAGE ENVIRONMENT: Storage temperature from –40 °C to 70 °C

RELATIVE HUMIDITY (R.H.): Relative humidity up to 95% at 40 °C (non-condensing)

POWER CONSUMPTION: Maximum 130 mVA for two 1.5 V AAA batteries

BATTERY TYPE: Alkaline 24 A (ANSI/NEDA) and LR03 (IEC), or Zinc Chloride 24 D (ANSI/NEDA) and R03 (IEC).

DIMENSION (W × L × H): 39.0 mm × 71.0 mm × 37.0 mm

WEIGHT: 60 g with battery

WARRANTY: Three months (Does not cover normal wear and tear of mechanical parts and batteries)

BLUETOOTH: Bluetooth Version 2.1 + EDR compliant, SPP profile, Class 2 device

SAFETY: The U1177A complies with the requirements of the following safety and regulatory standards:

- FCC Part15C (Certification) (15.209, 15.247) FCC ID: ZKMAGILENT-U1177A
- FCC Part15B (15.109)
- RSS–210 Issue 8:2010 IC: 6310A–U1177A
- ICES–003 Issue 4:2004
- EN 300 328 V1.7.1:2008
- EN 301 489–1V1.8.1:2008/–17 V2.11:2009
- EN 55022:2006+A1:2007/EN55024:1998+A1:2001+A2:2003
- EN 50371:2002
- EN 60950–1:2006/A11:2009/A1:2010
- India Equipment Type Approval (ETA) Certificate No: 1424/2011/WRLO
- COFETEL Certificate No: RCPAGU111-1066, registered under Agilent Technologies Mexico S de RL de CV

Complies with
IDA Standards
(DB 102425)

“This telecommunication equipment conforms to the NTC technical requirement”

NOTE: This equipment has been tested and found to comply with the limits for a Class B digital device, pursuant to part 15 of the FCC Rules. These limits are designed to provide reasonable protection against harmful interference in a residential installation. This equipment generates, uses, and can radiate radio frequency energy; and if not installed and used in accordance with the instructions, may cause harmful interference to radio communications. However, there is no guarantee that interference will not occur in a particular installation. If this equipment does cause harmful interference to radio or television reception, which can be determined by turning the equipment off and on, the user is encouraged to try to correct the interference by one or more of the following measures:

- Reorient or relocate the receiving antenna
- Increase the separation between the equipment and receiver
- Connect the equipment into an outlet on a circuit different from that to which the receiver is connected
- Consult the dealer or an experienced radio/TV technician for help

The term “IC” before the radio certification number only signifies that the device meets industry Canada technical specifications.

NOTE: Operation is subject to the following two conditions:

1. this device may not cause interference, and
2. this device must accept any interference, including interference that may cause undesired operation of the device.

The changes or modifications not expressly approved by the party responsible for compliance could void the user's authority to operate the equipment. To comply with the RF exposure compliance requirements, this device and its antenna must not be co-located or operating in conjunction with any other antenna or transmitter.

Le terme « IC » qui figure devant le numéro de certification radio signifie seulement que le périphérique est conforme aux spécifications techniques imposées par Industrie Canada.

Son fonctionnement est soumis aux deux conditions suivantes :

1. ce périphérique ne doit pas provoquer d'interférences, et
2. ce périphérique doit accepter toutes les interférences, y compris celles qui pourraient entraîner un fonctionnement inopportun.

Les changements ou modifications qui ne sont pas expressément approuvés par la partie responsable de la conformité sont susceptibles d'annuler le droit de l'utilisateur à se servir de l'équipement. Pour être conformes aux exigences de conformité en matière d'exposition aux fréquences radio, ce périphérique et son antenne ne doivent pas être installés au même endroit ni être utilisés en conjonction avec une autre antenne ou un autre transmetteur.

NOTE

- Do not open the plastic case unnecessarily. Doing so may cause damage to the plastic case.
- Keep the adapter away from getting wet.
- Ensure the adapter is turned OFF and the battery cover is removed when replacing the batteries.
- The batteries must be recycled or disposed properly after depletion.
- If the LED is not lighted when turned on, replace the batteries with new specified batteries.
- The adapter can only be used with Agilent handheld digital multimeters.

Configuration

The table below shows you the default configurations for the U1177A.

Parameters	Default Configurations	Parameters	Default Configurations
PIN code	1234	Stop bit	1
Baud rate	9600	Deep sleep timer	900 seconds
Data bit	8	Mode	Discoverable
Parity	None		

NOTE

The COM port configurations for the U1177A, the handheld multimeter, and the PC/smartphone/tablet must be matched before communication can be established. All U1177A units and handheld multimeters are shipped with the same default COM port configurations as shown above.

Set Up the U1177A with a Computer Bluetooth Connection

NOTE

- Before you begin, make sure the **Bluetooth** connection on your PC is enabled.
- It is recommended to use brand new batteries before running any operations that are critical or require a longer duration.

1. Set the U1177A slide switch to **On**.
2. From your PC, go to **Start > My Computer > My Bluetooth Places**.
3. Click **Add a Bluetooth Device** to open the Bluetooth Setup Wizard.
4. Click **Next>**. The Bluetooth Device Selection will display a list of bluetooth devices.
5. Select **Agilent U1177A-XXXXXX**—the XXXXXX represents U1177A device ID—and click **Next>**.
6. In the Pair Now tab, type the default **Bluetooth** security code “1234” and click **Pair Now**.
7. Once pairing is successful, check **SPP** as your selected **Bluetooth** service and click **Next>**.
8. A shortcut display notification pop-up window will appear. Click **OK**.
9. Upon completion of the Bluetooth Setup Wizard, rename the device if required.
10. Click **Finish** to complete the connection. The **U1177A-XXXXXX** is now added and connected successfully.
11. If you already had the U1177A added in My Bluetooth Places, double-click **U1177A** to establish a wireless serial connection with your remote multimeter.
12. Double-click **U1177A** again to disconnect the wireless serial connection.

NOTE

In some cases, the Bluetooth Device Manager will create two COM ports. Use the COM port with the “Outgoing” label only.

Operation

Connect Your U1177A Adapter to the Multimeter

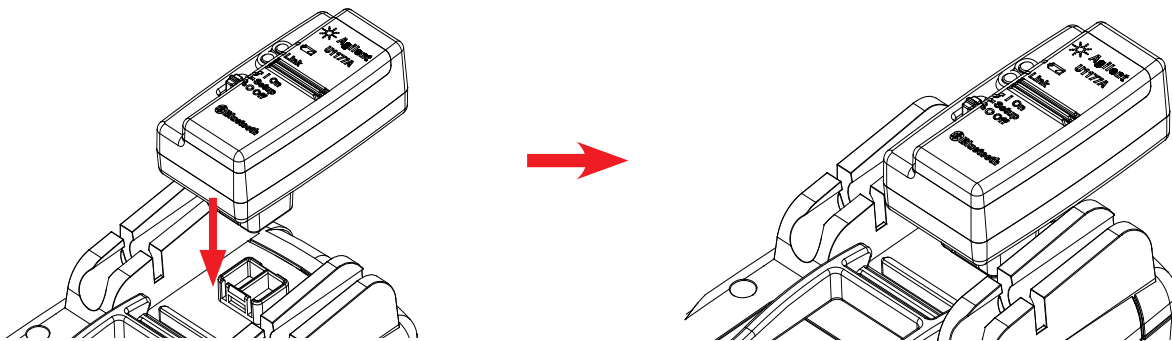

Snap the optic side of the U1177A to the multimeter IR communication port.

Install and Replace the Batteries

NOTE

Make sure you turn off the U1177A before installing or replacing the batteries.

CAUTION

To avoid the U1177A being damage from battery leakage:

- Always remove dead batteries immediately.
- Always remove the batteries and store them seperately if the adapter is not going to be used for a long period.

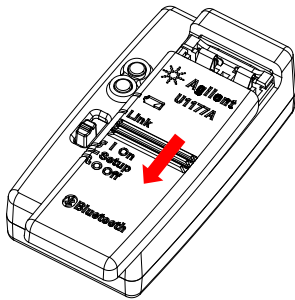

1. Slide the battery cover away from adapter's body.

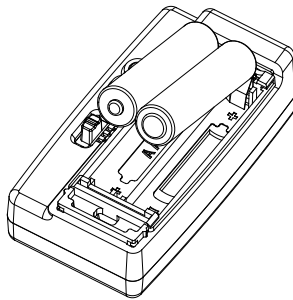

2. Insert the battery.

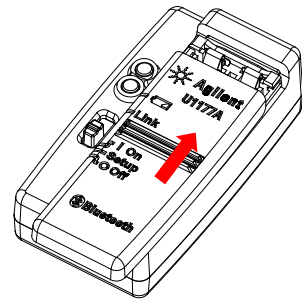

3. Reverse the sliding position to close the battery cover.

Turn On the U1177A

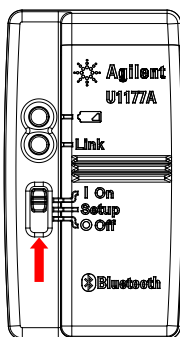

Set the slide switch to **On**.

Configure the U1177A

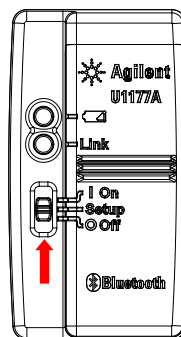

Set the slide switch to **Setup**.

Reset the U1177A

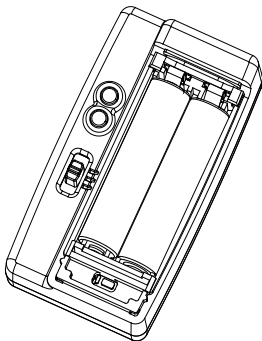

1. Open the battery cover. Then, set the slide switch to **Setup**.

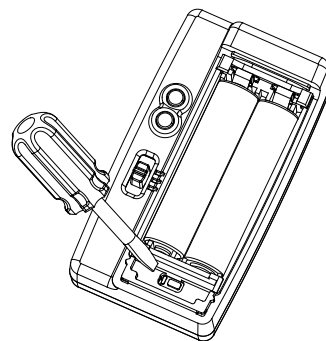

2. Use a flat-blade screwdriver to push the button located in the hole for around three seconds.

Connect a Multimeter to the Agilent GUI Data Logger via the U1177A

1. Open the Agilent GUI Data Logger.
2. In the Communication Setting panel, the setup mode is set to Auto by default. Click **Connect Meter** to establish the multimeter connection.
3. The multimeter will remain connected until the COM port is closed or the U1177A is turned off.

NOTE

- If you wish to set up the multimeter connection manually, select **Manual** from the Communication Setting panel. Make sure you select the COM port your multimeter is connected and set the baud rate, parity, and data bit to the default configuration.
 - Only one host computer is able to connect to the U1177A at a time.
-

Maintenance

If any part of the adapter is worn out or damaged, replace it with a new U1177A adapter.

Additional Information

For more information on configuring the U1177A via Hyper Terminal and AT Commands, please refer to the *Agilent U1177A IR-to-Bluetooth Adapter Configuration Guide* ([U1177-90002](#)).

Agilent Mobile Apps

Agilent has two Mobile Apps available for use with this product; Agilent Mobile Meter and Agilent Mobile Logger.

Both the Mobile Apps are compatible with PC and Android devices and are available on the Google Play app store.

These Mobile Apps allow you to wirelessly control your Agilent digital handheld meter with your Android smartphone via the Agilent U1177A IR-to-Bluetooth Adapter.

All Agilent handheld digital multimeters are supported, with the exception of the Agilent U1240 Series, which requires an additional Agilent U1179A IR Connectivity Bracket for compatibility with the Agilent U1177A IR-to-Bluetooth Adapter.

Visit the URLs below for more information on the Agilent Mobile Apps:

<http://play.google.com/store/apps/details?id=com.agilent.mobilemeter>

<http://play.google.com/store/apps/details?id=com.agilent.mobilemeterlogger>



U1177-90101

©Agilent Technologies, Inc., 2012
Printed in Malaysia
November 9, 2012

Modelo U1177A



3533-11-7510



(01) 07898994220619

“Este equipamento opera em caráter secundário, isto é, não tem direito a proteção contra interferência prejudicial, mesmo de estações do mesmo tipo, e não pode causar interferência a sistemas operando em caráter primário.”



Agilent Technologies