

5 4 3 2 1

D
C
B
A

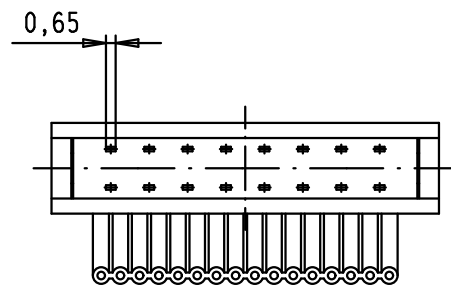

PCB layout, component side

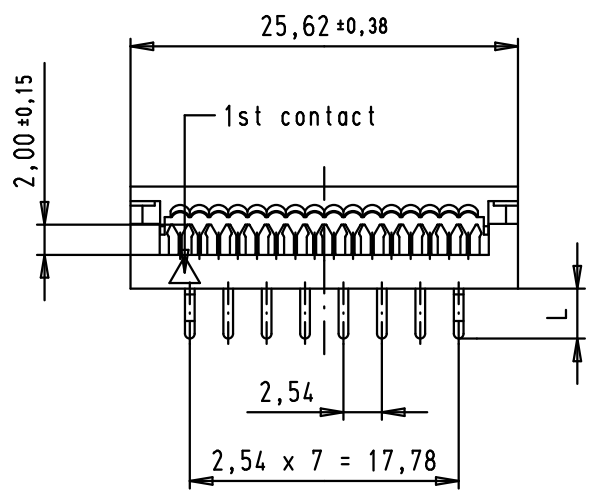
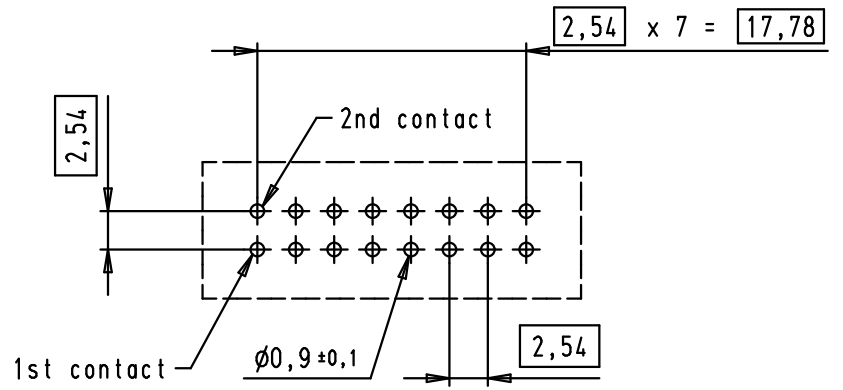

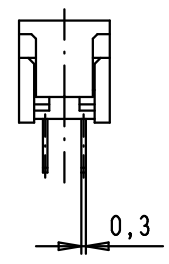

PRE-ASSEMBLED

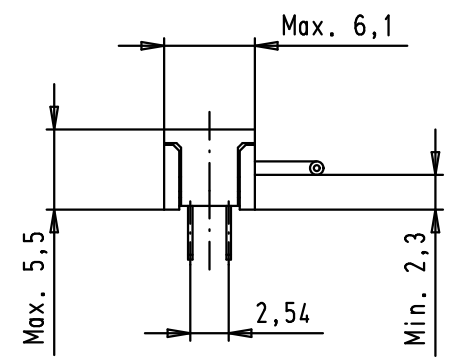

ASSEMBLED

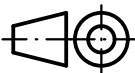

| | | |
|--------------------|----------------------|---------------|
| 09 18 116 9622.210 | 3,0 ^{±0,25} | PRE-ASSEMBLED |
| 09 18 116 9622.200 | 3,3 ^{±0,25} | NON ASSEMBLED |
| 09 18 116 9622 | 3,3 ^{±0,25} | PRE-ASSEMBLED |
| Part number | L | COVER |

| | | | | | | |
|-------|----------|----|-------------------------------|----------|------|---|
| | | | | Dat. | Name |  All Dim. in mm Orig. Size DIN A 4 |
| | | | Detail. | 02/04/04 | JH | |
| | | | Insp. | | | |
| | | | Stand. | | | |
| 34919 | 30/05/08 | PK | HARTING EURL F-95972 Paris | | |  |
| 34889 | 08/04/08 | PK | Mod. | Dat. | Name | |
| 31884 | 02/04/04 | JH | | | | |

| | |
|---|--------------------------|
| SEK 18, low profile, PCB transition, 16 poles, 2 rows | Maßstab/ Scale 2:1 |
| TB 09 18 116 9622 | Blatt/ Page 1 / 1 |
| Sub. | |