

G5XX, TYPE A SERIES

HAND-HELD ELECTRONIC ENCLOSURE

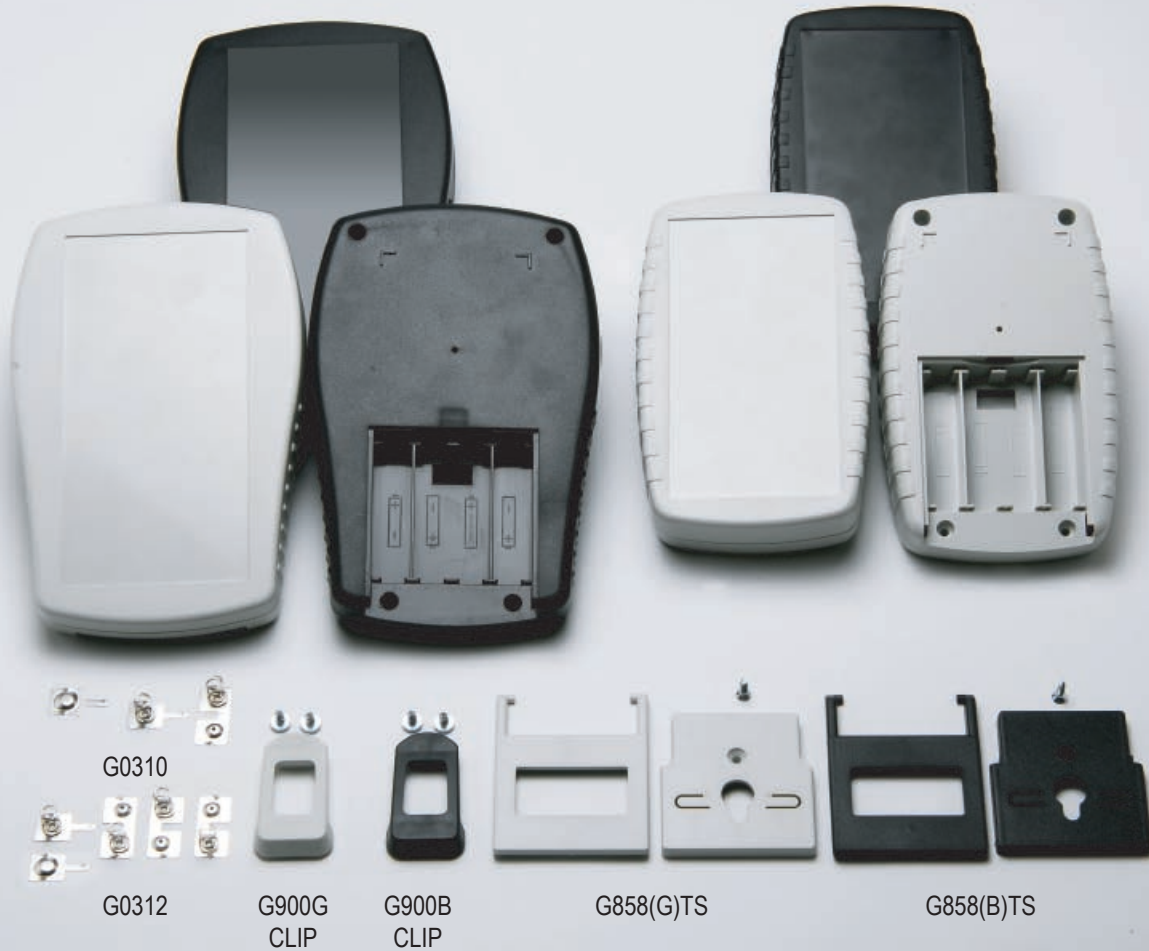

PRODUCT INFORMATION

MATERIAL:

- High-impact ABS plastic, Grey and black color.

FEATURES:

- Designed to accept two or four "AA" battery & 9V 216 type.
- G0310 => 2 AA Battery contact kit is optional for ordering.
- G0312 => 4 AA Battery contact kit is optional for ordering.
- G900B Clip
=> Black belt clip (*optional)
- G900G Clip
=> Grey belt clip (*optional)
- G858(G)TS & G858(B)TS
- tilt stand is optional for selection.



G0310



G0312

ITEM No.	COLOR	RECESSED DISPLAY AREA	BATTERY COMPARTMENT	EXTERNAL DIMENSION(mm)
G500G	Grey	120 x 65 mm	NO	120 x 65 mm
G500B	Black	120 x 65 mm	NO	120 x 65 mm
G500G(BC)	Grey	120 x 65 mm	Yes	120 x 65 mm
G500B(BC)	Black	120 x 65 mm	Yes	120 x 65 mm
G503G	Grey	140 x 70 mm	NO	140 x 70 mm
G503B	Black	140 x 70 mm	NO	140 x 70 mm
G503G(BC)	Grey	140 x 70 mm	Yes	140 x 70 mm
G503B(BC)	Black	140 x 70 mm	Yes	140 x 70 mm

G500B/ G500G

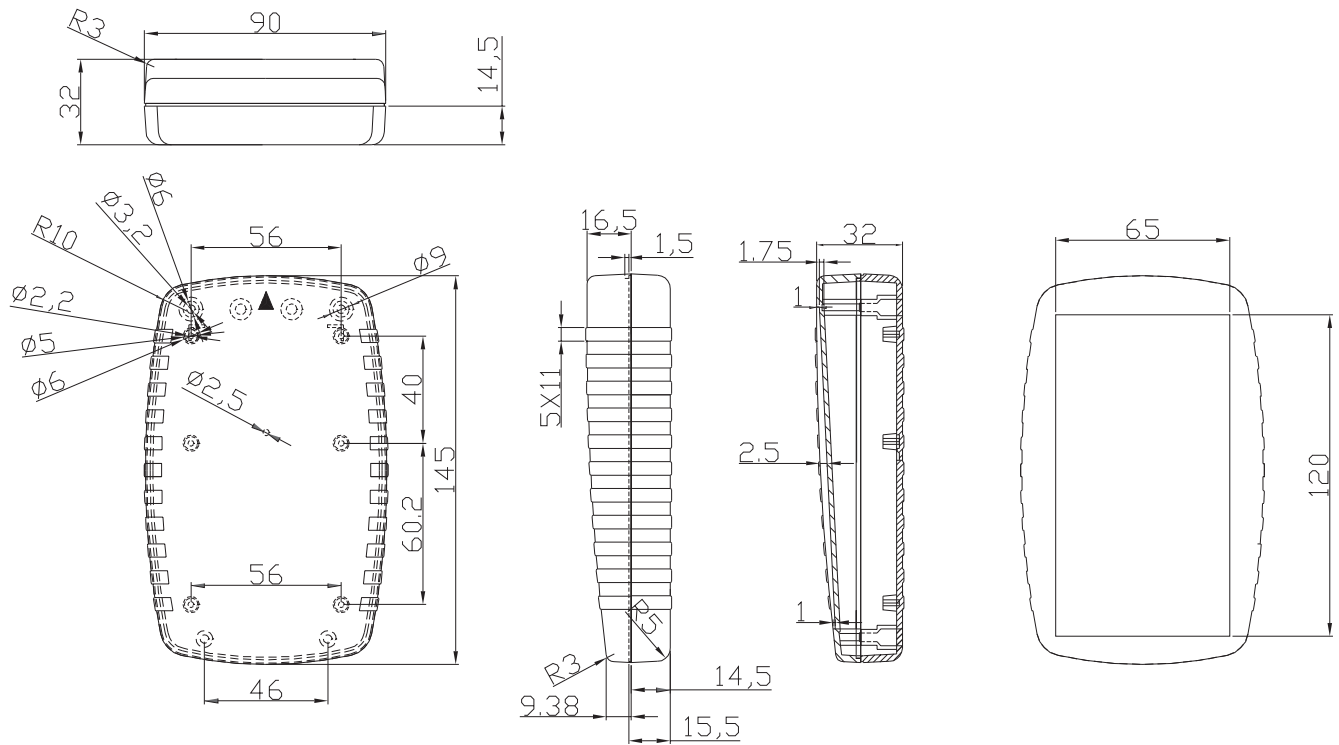

G500B(BC) / G500G(BC)

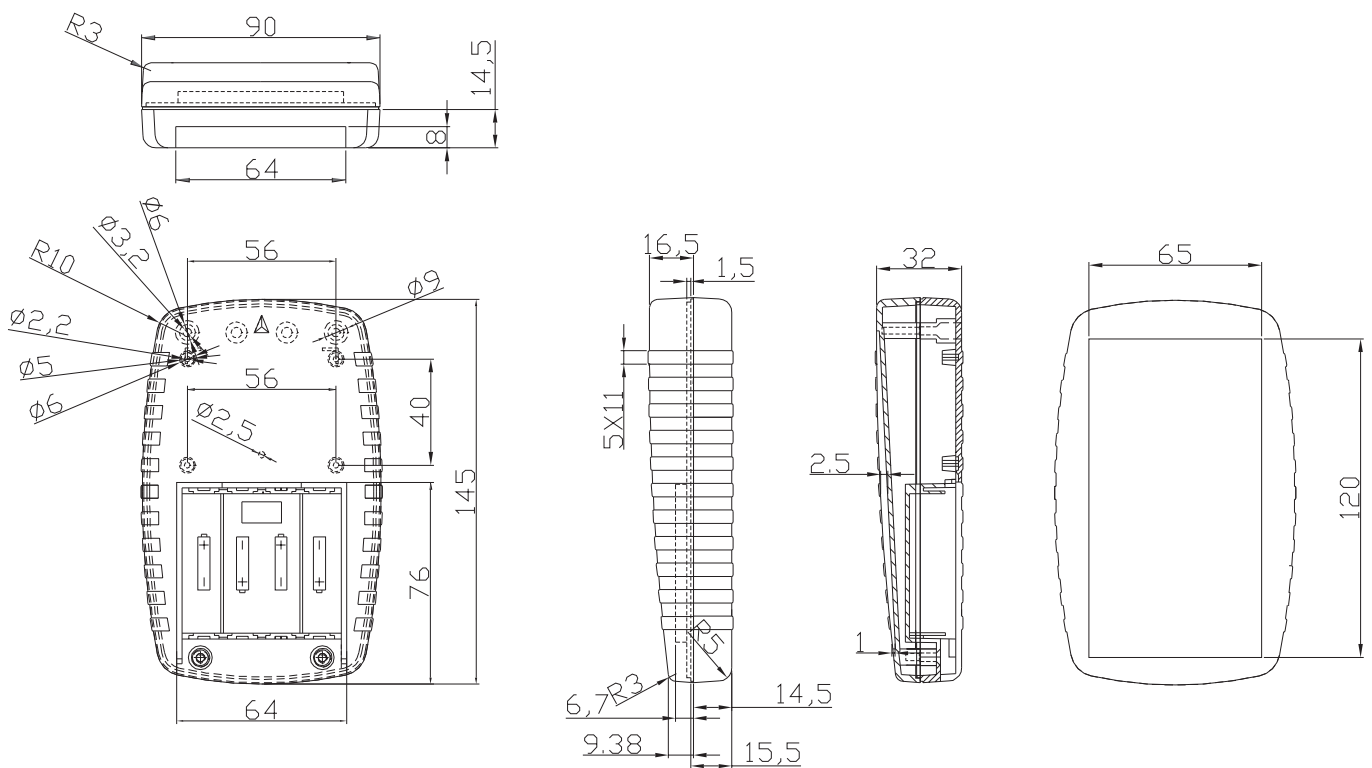

G503B/ G503G

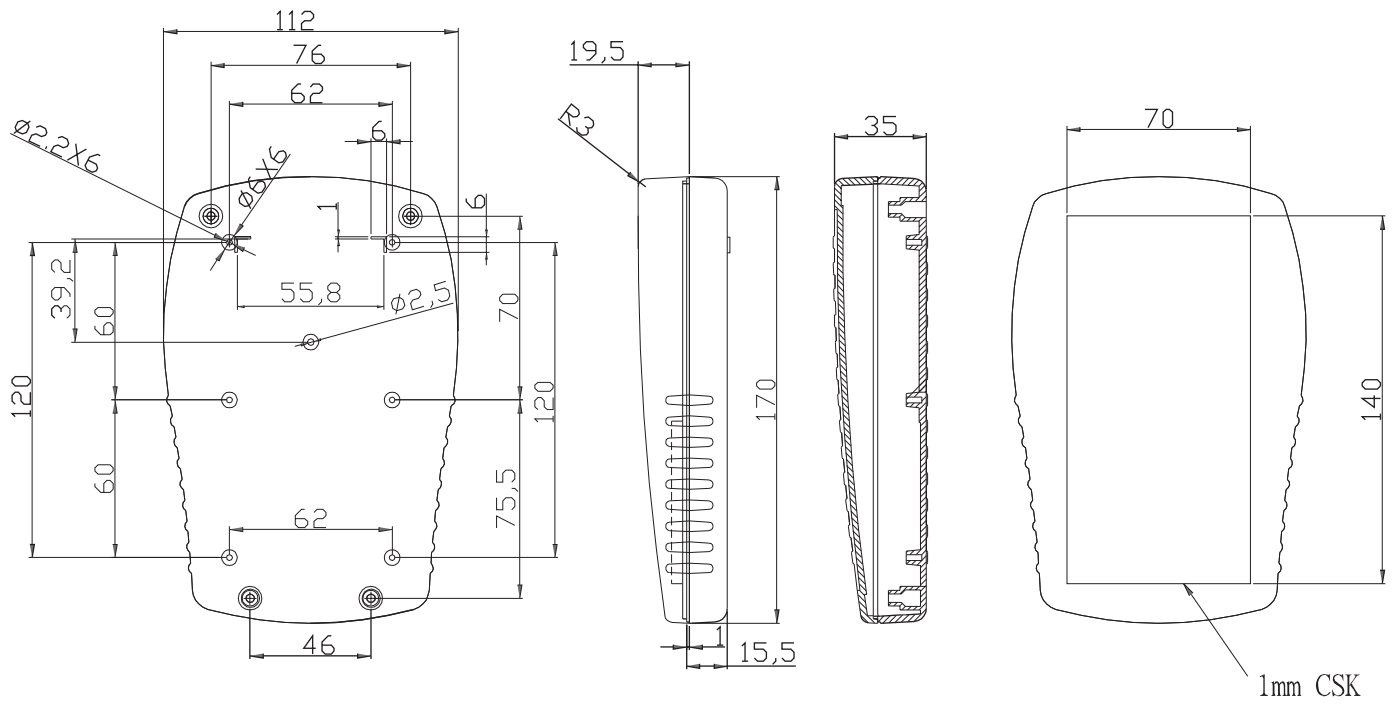

G503B(BC) / G503G(BC)

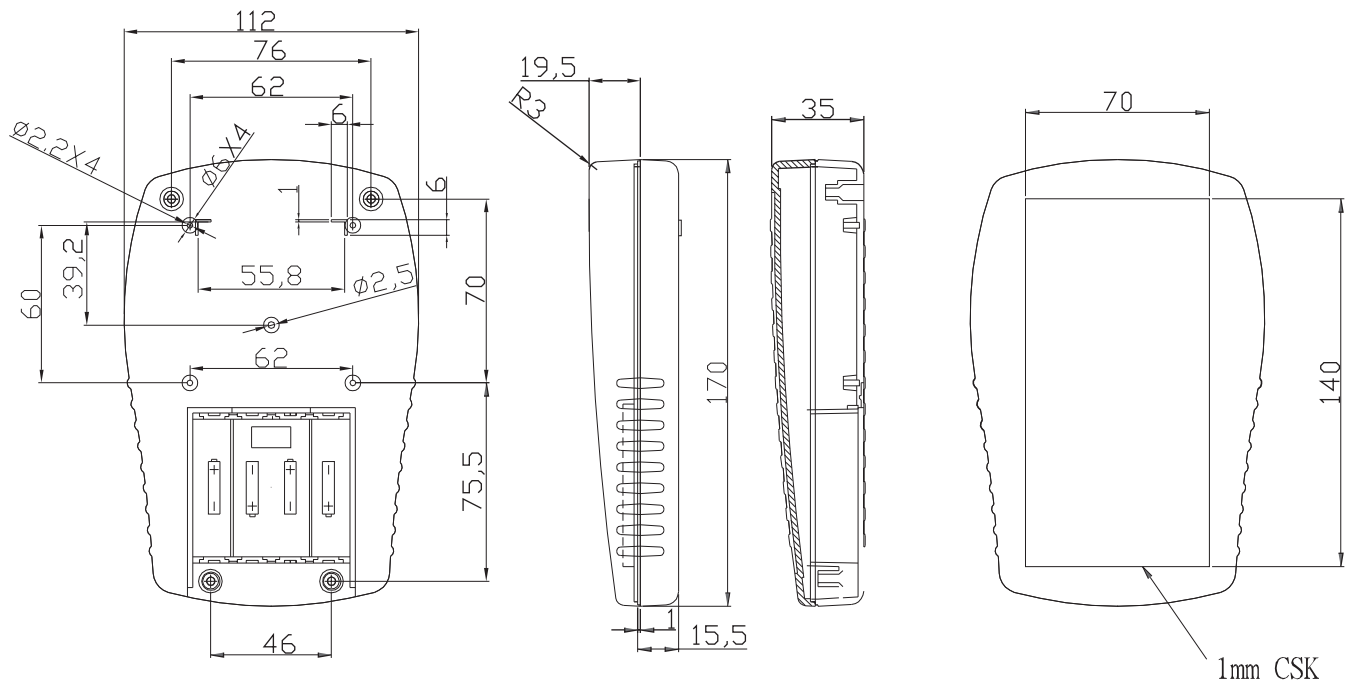

G5XX, TYPE B SERIES

HAND-HELD ELECTRONIC ENCLOSURE



PRODUCT INFORMATION

- MATERIAL: High impact UL94-HB, ABS.
- Available in light grey and black colors.
- Ideally suitable for housing remote controls, medical devices, scientific instruments or communications equipment.
- Recessed area in the top lid, ideally suitable for membrane keypad use.
- G517, G528 offer the battery compartment, and they are designed to accept two "AAA" batteries, our "GSN-42-1PP" – 2 X AAA battery holder with 150mm of wires is an optional item.
- G519, G529 & G537 offer the battery compartment, and they are designed to accept either 9V or two "AA".
- Batteries, our "GSN-32-2PP" – 2 X AA battery holder with 150mm of wires, and "GSN-9V-1A" – 9V battery holder with 150mm of wires are optional items.
- Flush panels (IR panel - "\$" ; "@" ; "%" ; "&") are available for selection.
- "G900B Clip" – black belt clip or "G900G Clip" – grey belt clip is also an optional item for G512, G515, G517, G519, G521, G526, G528, G529, G537 & G539.

ITEM No.	EXTERNAL DIMENSION(mm)	DESCRIPTION
G512G-2\$	66.5 X 66.5 X 28	PLASTIC BOX ,GREY, WITH 2 END PANELS-"\$"
G512B-2\$	66.5 X 66.5 X 28	PLASTIC BOX,BLACK, WITH 2 END PANELS-"\$"
G515G	66.5 X 66.5 X 28	PLASTIC BOX,GREY
G515B	66.5 X 66.5 X 28	PLASTIC BOX,BLACK
G517G(BC)-1@	92 X 66.5 X 21	PLASTIC BOX,GREY, WITH 1 END PANEL-"@" AND BATTERY COMPARTMENT
G517B(BC)-1@	92 X 66.5 X 21	PLASTIC BOX,BLACK, WITH 1 END PANEL-"@" AND BATTERY COMPARTMENT
G519G(BC)-1\$	92 X 66.5 X 28	PLASTIC BOX,GREY, WITH 1 END PANEL-"\$" AND BATTERY COMPARTMENT
G519B(BC)-1\$	92 X 66.5 X 28	PLASTIC BOX,BLACK, WITH 1 END PANEL-"\$" AND BATTERY COMPARTMENT
G521G-2\$	92 X 66.5 X 28	PLASTIC BOX,GREY, WITH 2 END PANELS-"\$"
G521B-2\$	92 X 66.5 X 28	PLASTIC BOX,BLACK, WITH 2 END PANELS-"\$"
G526G-2#	111.3 X 75 X 25.2	PLASTIC BOX,GREY, WITH 2 END PANELS-"#"
G526B-2#	111.3 X 75 X 25.2	PLASTIC BOX,BLACK, WITH 2 END PANELS-"#"
G528G(BC)-1@	112 X 66.5 X 21	PLASTIC BOX,GREY, WITH 1 END PANEL-"@" AND BATTERY COMPARTMENT
G528B(BC)-1@	112 X 66.5 X 21	PLASTIC BOX,BLACK, WITH 1 END PANEL-"@" AND BATTERY COMPARTMENT
G529G(BC)-1\$	112 X 66.5 X 28	PLASTIC BOX,GREY, WITH 1 END PANEL-"\$" AND BATTERY COMPARTMENT
G529B(BC)-1\$	112 X 66.5 X 28	PLASTIC BOX,BLACK , WITH 1 END PANEL-"\$" AND BATTERY COMPARTMENT
G535G-2%	114 X 35.7 X 25.8	PLASTIC BOX,GREY, WITH 2 END PANELS-"%"
G535B-2%	114 X 35.7 X 25.8	PLASTIC BOX,BLACK, WITH 2 END PANELS-"%"
G537G(BC)-1\$	140 X 66.5 X 28	PLASTIC BOX,GREY, WITH 1 END PANEL-"\$" AND BATTERY COMPARTMENT
G537B(BC)-1\$	140 X 66.5 X 28	PLASTIC BOX,BLACK, WITH 1 END PANEL-"\$" AND BATTERY COMPARTMENT
G539G-2\$	140 X 66.5 X 28	PLASTIC BOX,GREY, WITH 2 END PANELS-"\$"
G539B-2\$	140 X 66.5 X 28	PLASTIC BOX,BLACK, WITH 2 END PANELS-"\$"
IR PANEL-``\$``	61.2 X 22.9 X1.6	IR PANEL FOR G512,G519,G521,G529,G537,G539 USE
IR PANEL- ``@``	61.2 X 15.7 X1.6	IR PANEL FOR G517,G528 USE
IR PANEL- ``#``	69.7 X 19.9 X1.6	IR PANEL FOR G526 USE
IR PANEL- ``%``	30.4 X 20.5 X1.6	IR PANE FOR G535 USE

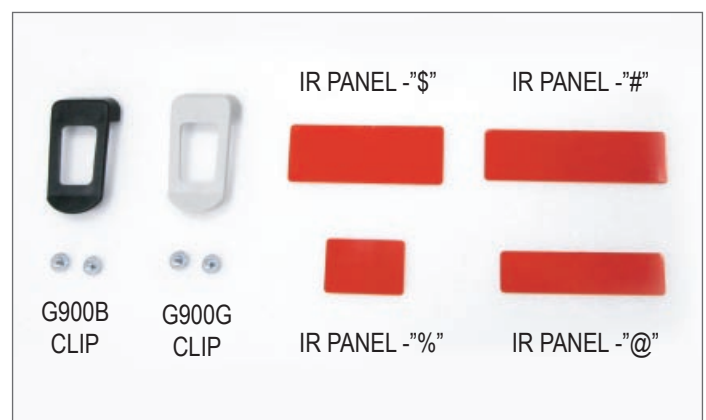
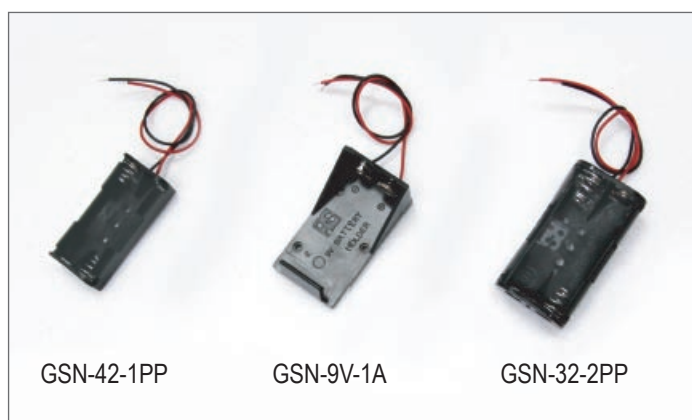

G512B-2\$ / G512G-2\$

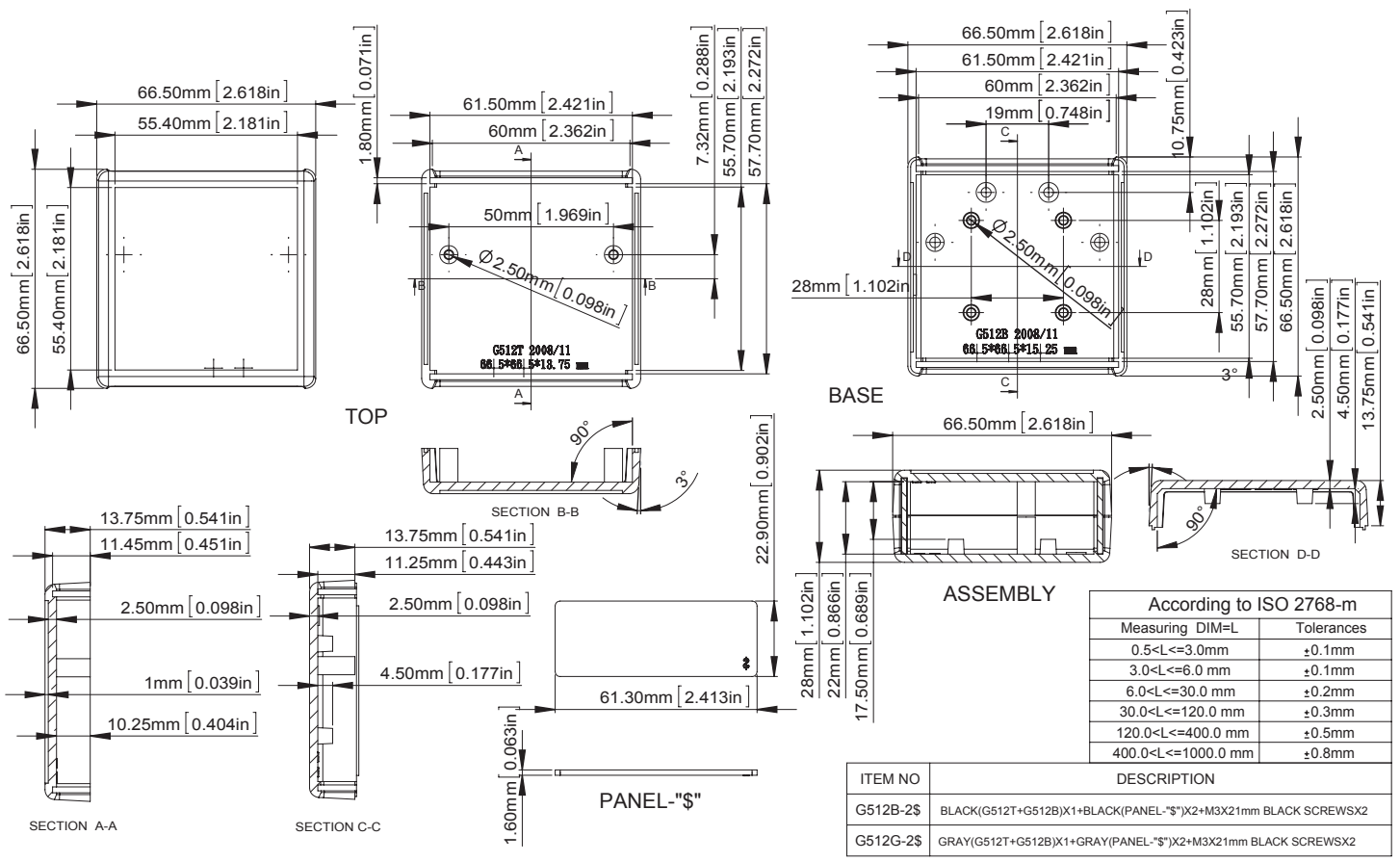

G515B / G515G

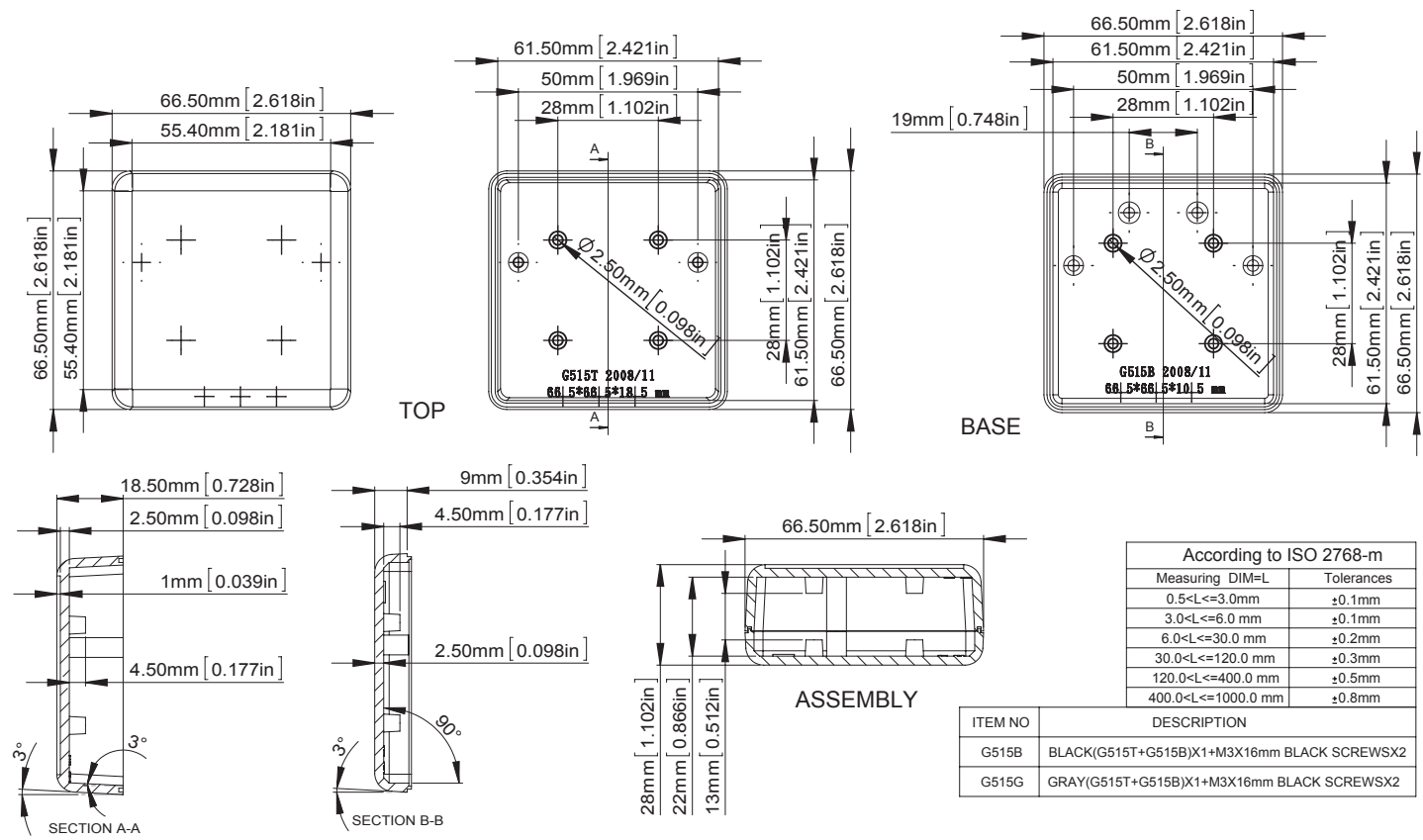

G517B(BC)-1@ / G517G(BC)-1@

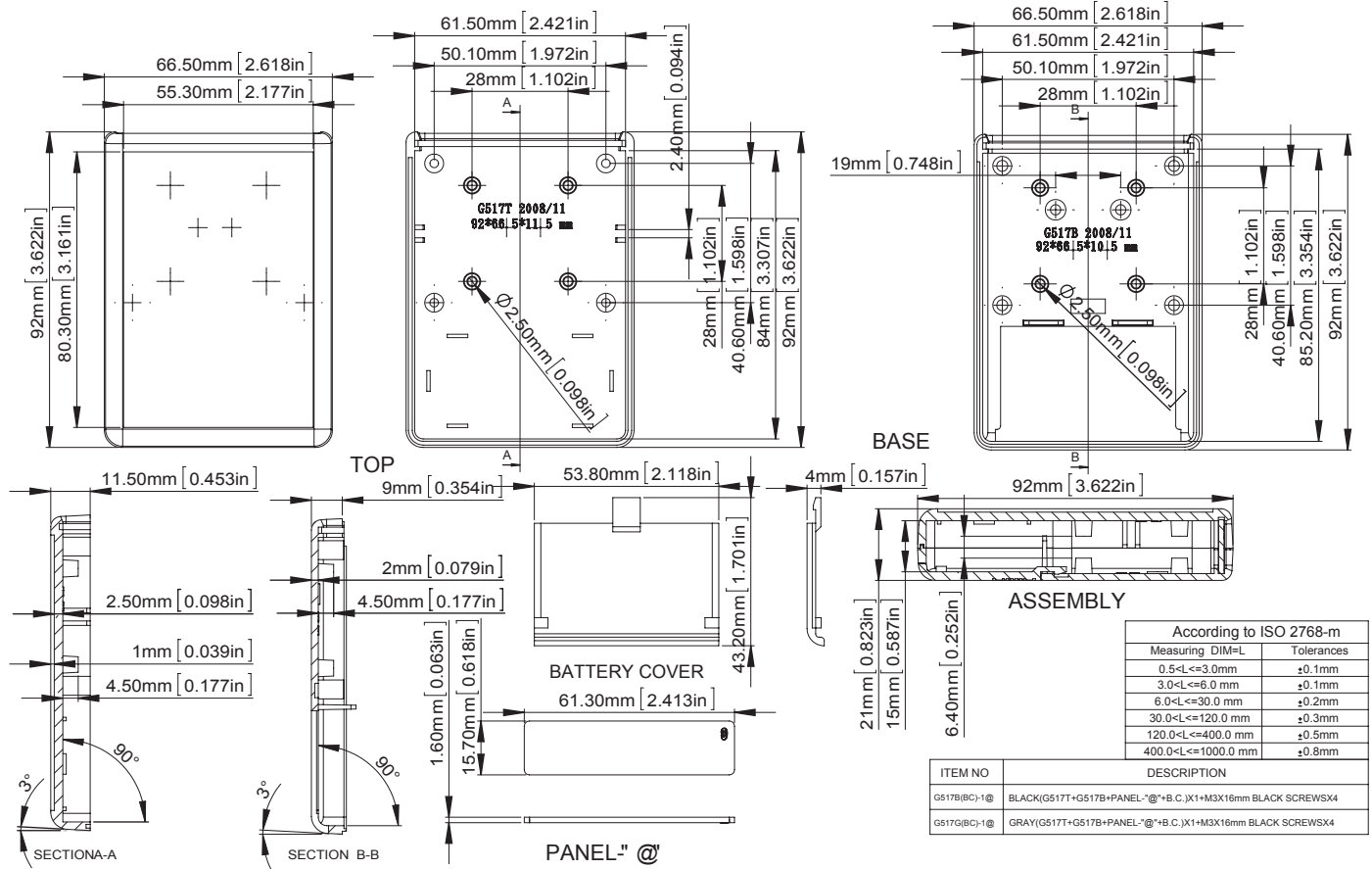

G519B(BC)-1\$ / G517G(BC)-1\$

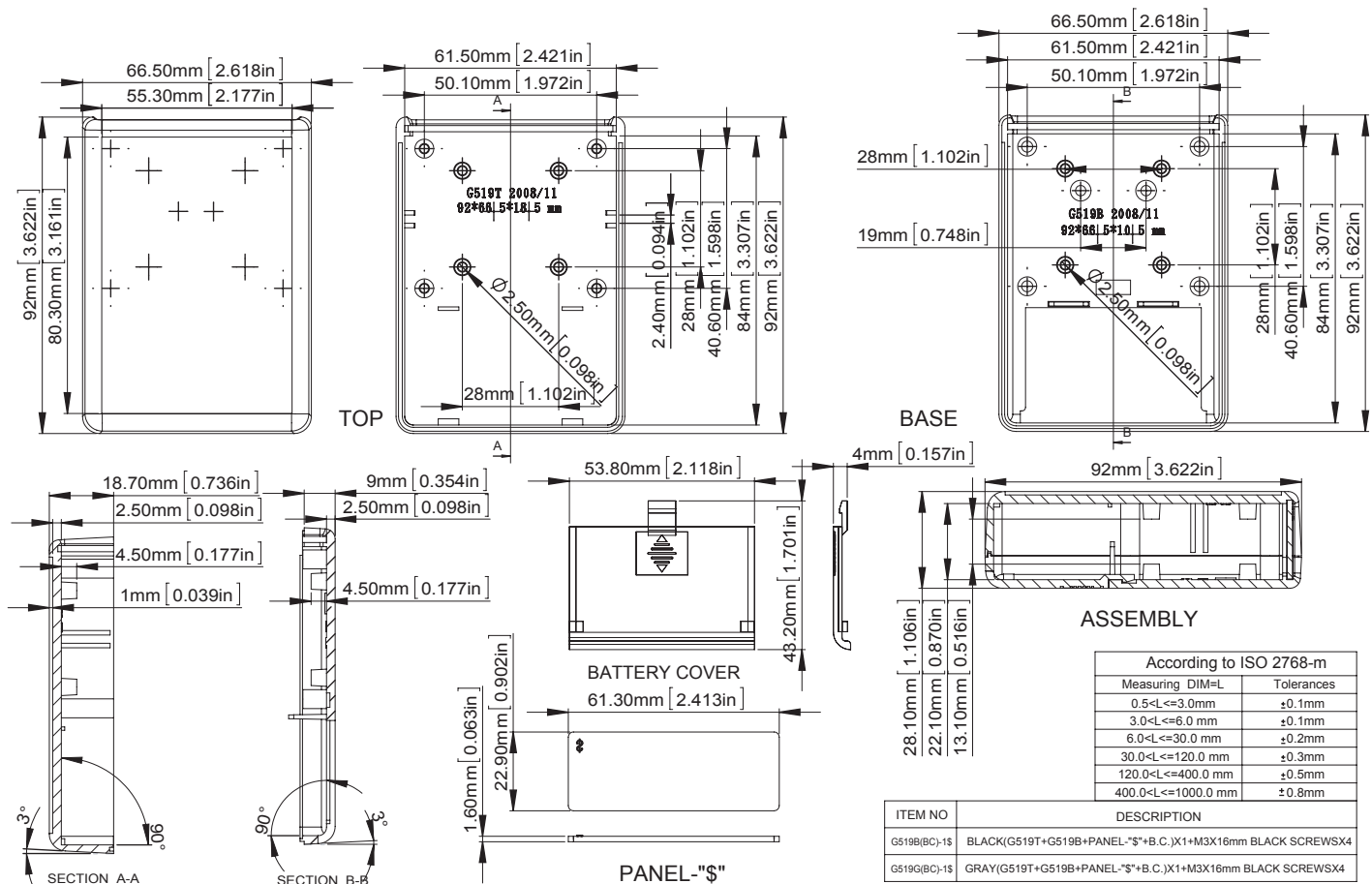

G521B-2\$ / G521G-2\$

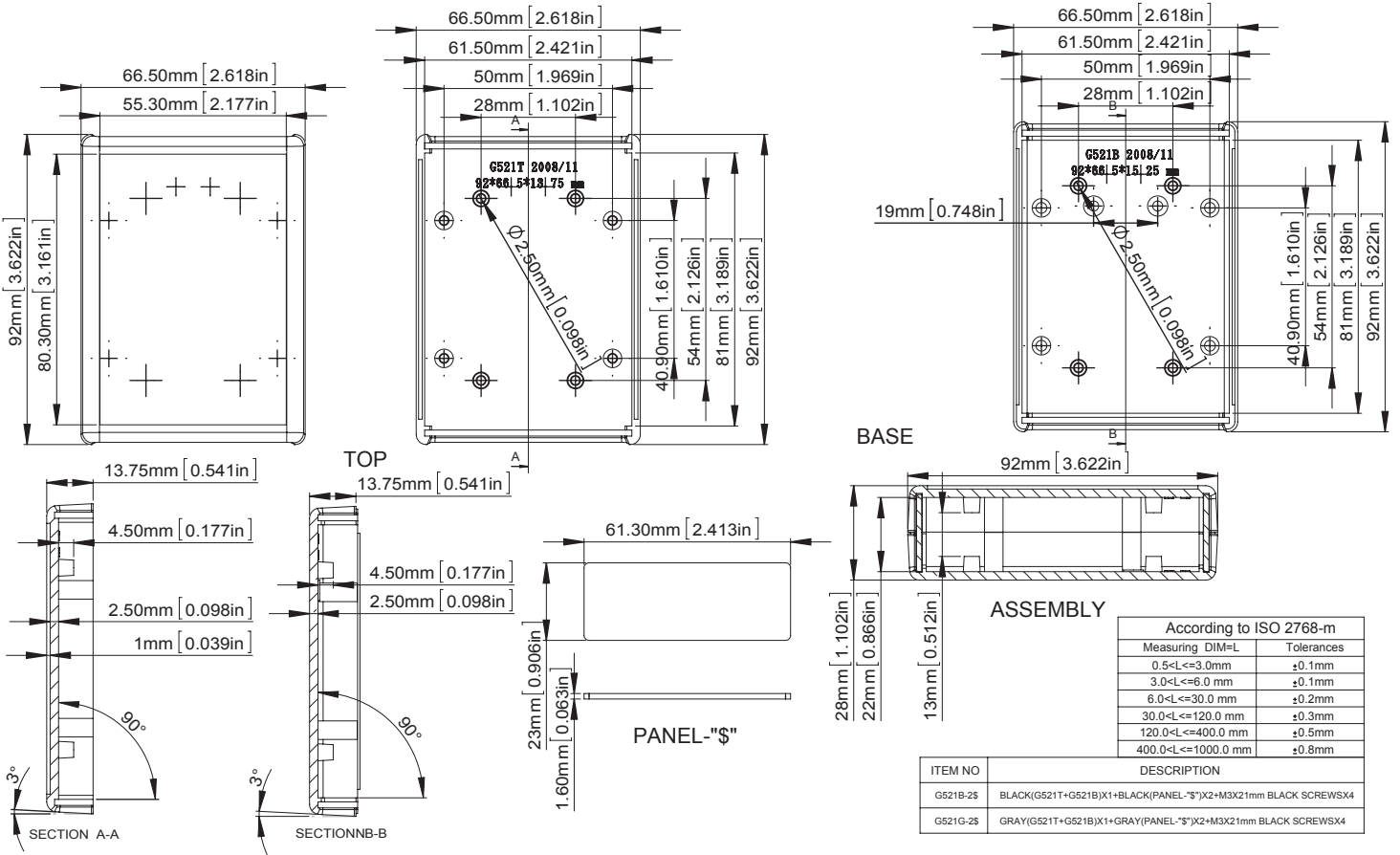

G526B-2# / G526G-2#

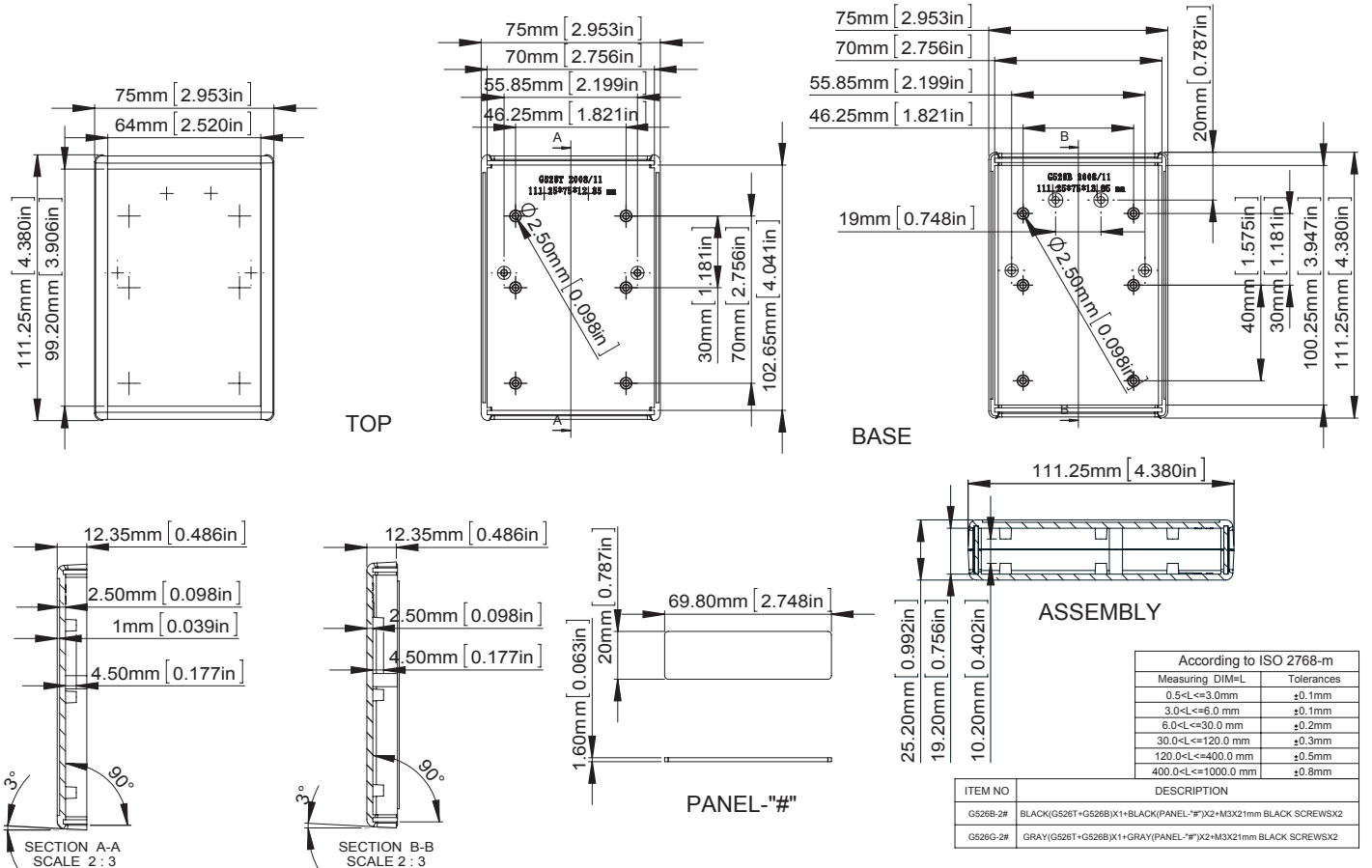

G528B(BC)-1@ / G528G(BC)-1@

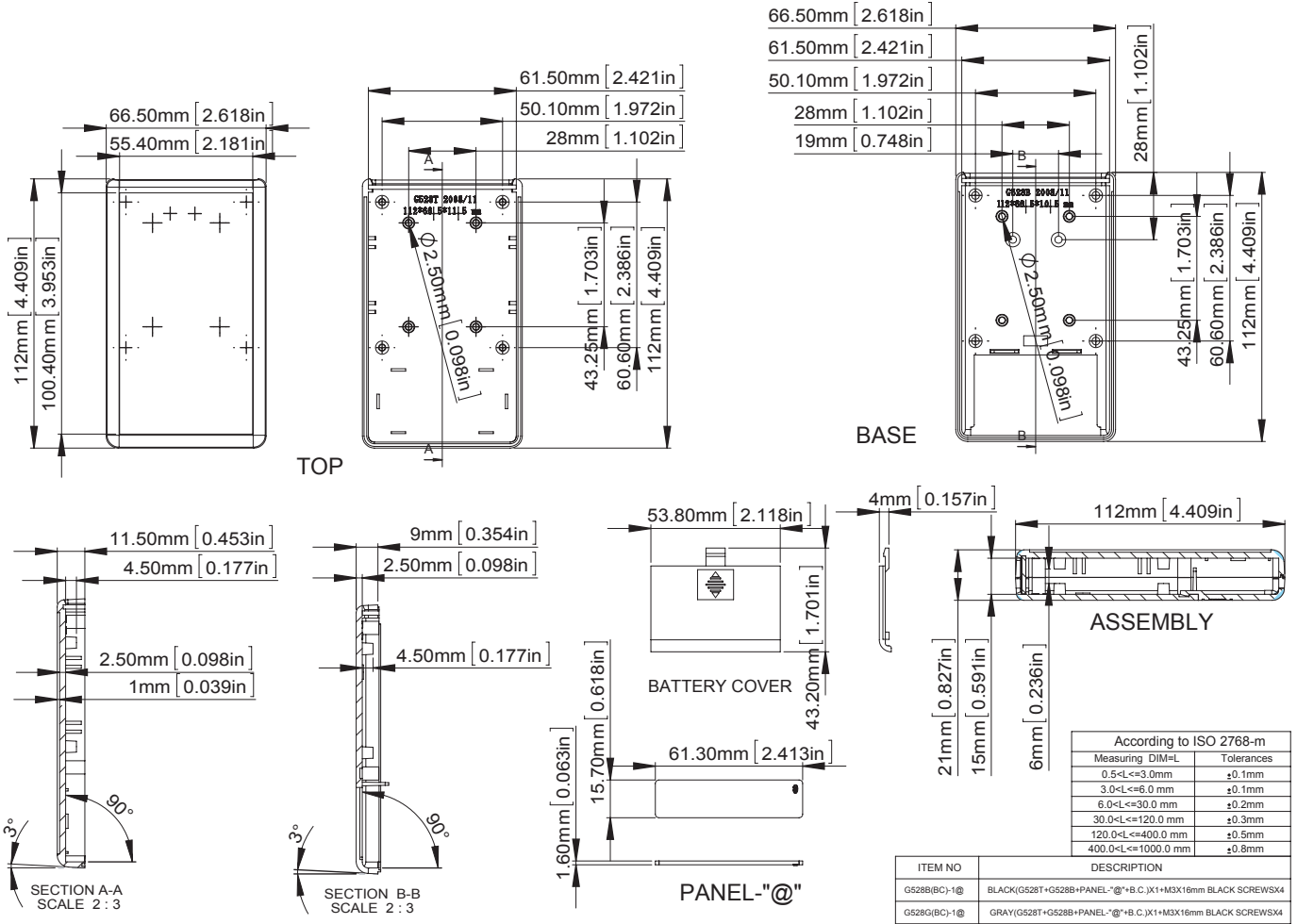

G529B(BC)-1\$ / G529G(BC)-1\$

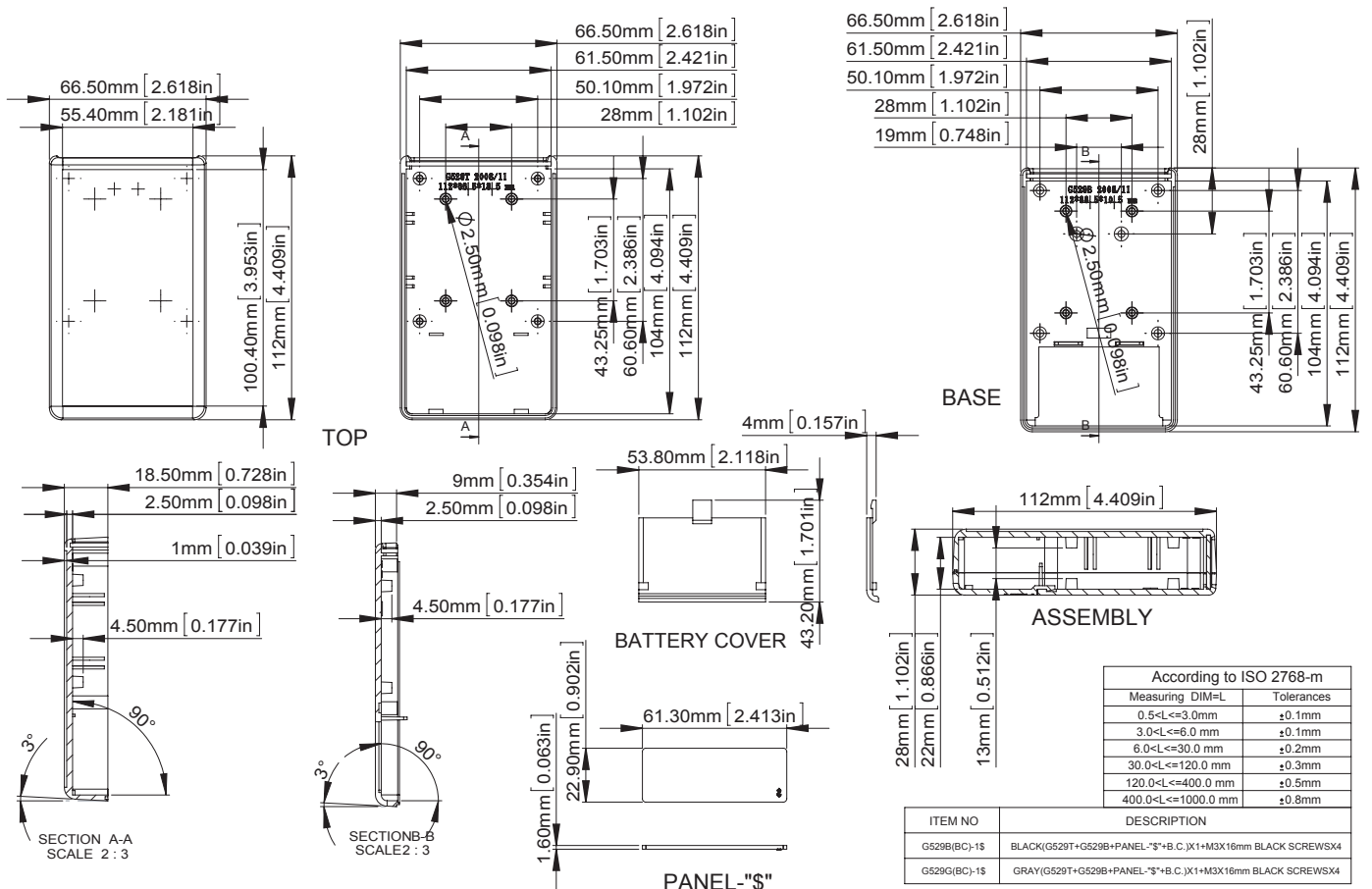

G537B(BC) -1\$ / G537G(BC)-1\$

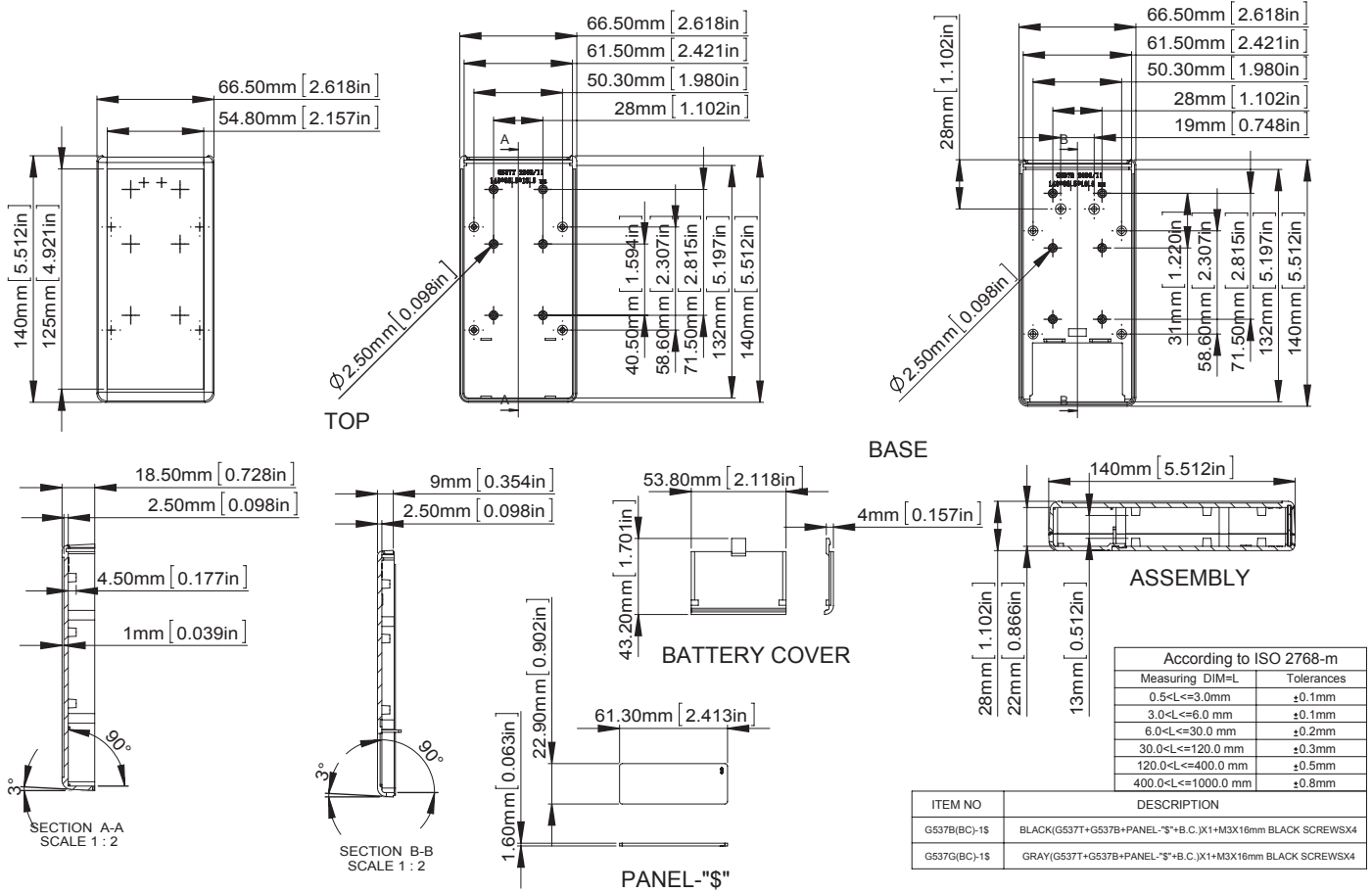

G539B-2\$ / G539G-2\$

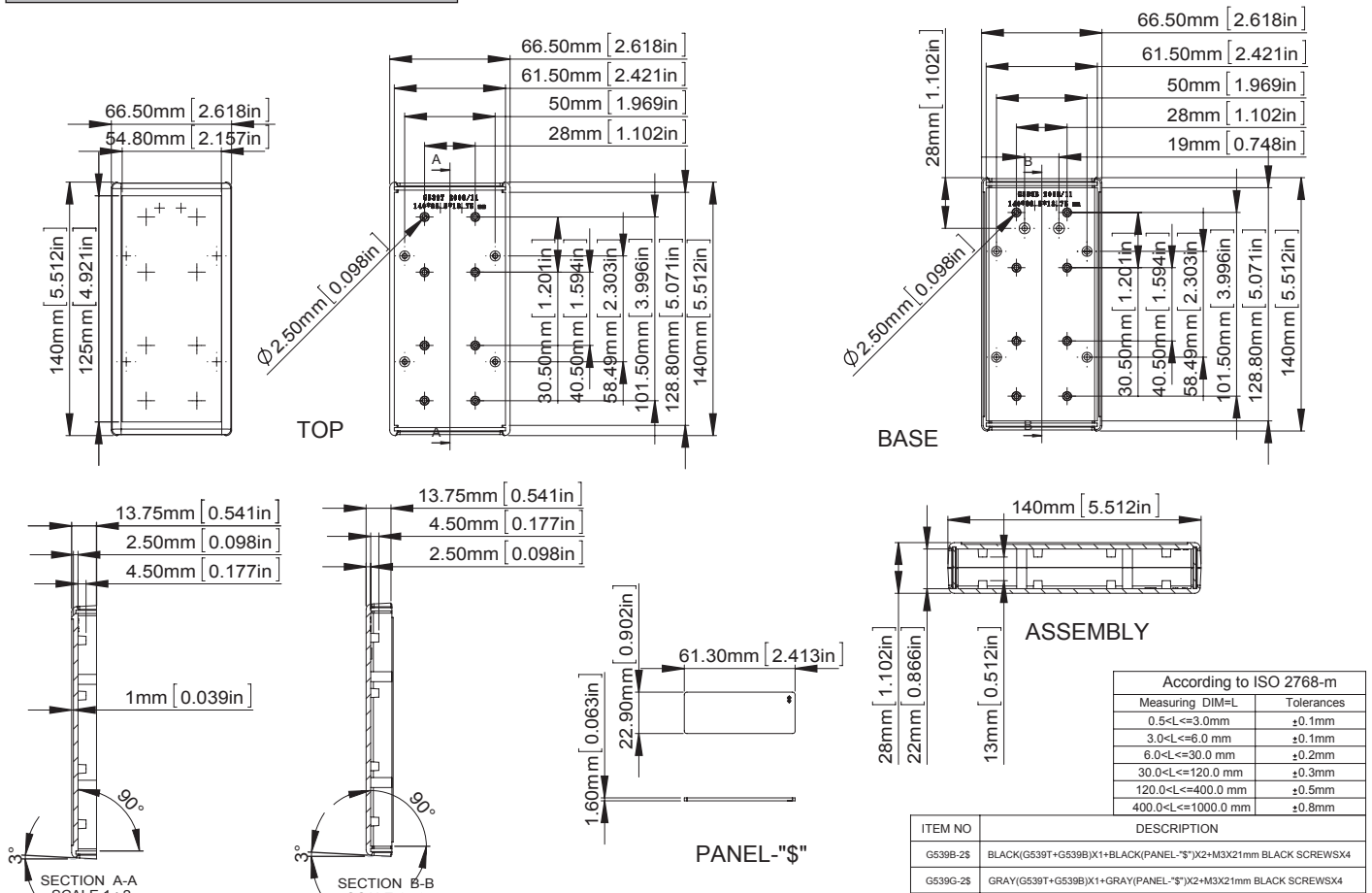

Panels (For G5XX TYPE B use)

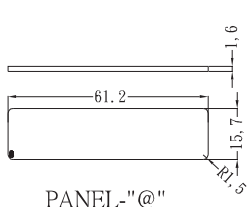
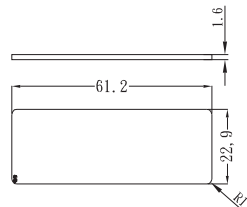
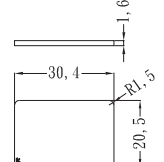
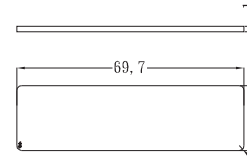
 <p>PANEL-"@"</p> <table border="1" data-bbox="414 321 763 493"> <thead> <tr> <th>ITEM NO</th> <th>DESCRIPTION</th> </tr> </thead> <tbody> <tr> <td>BK PANEL "@"</td> <td>BLACK PANEL "@" FOR G517B(BC)/G528B(BC) USE</td> </tr> <tr> <td>GY PANEL "@"</td> <td>GRAY PANEL "@" FOR G517G(BC)/G528G(BC) USE</td> </tr> <tr> <td>IR PANEL "@"</td> <td>RED TRANSPARENT PANEL "@" FOR G517(BC)/G528(BC) USE</td> </tr> </tbody> </table>	ITEM NO	DESCRIPTION	BK PANEL "@"	BLACK PANEL "@" FOR G517B(BC)/G528B(BC) USE	GY PANEL "@"	GRAY PANEL "@" FOR G517G(BC)/G528G(BC) USE	IR PANEL "@"	RED TRANSPARENT PANEL "@" FOR G517(BC)/G528(BC) USE	 <p>PANEL-"\$"</p> <table border="1" data-bbox="1055 321 1477 493"> <thead> <tr> <th>ITEM NO</th> <th>DESCRIPTION</th> </tr> </thead> <tbody> <tr> <td>BK PANEL "\$"</td> <td>BLACK PANEL "\$" FOR G512B/G519B(BC)/G521B/G529B(BC)/G537B(BC)/G539B USE</td> </tr> <tr> <td>GY PANEL "\$"</td> <td>GRAY PANEL "\$" FOR G512G/G519G(BC)/G521G/G529G(BC)/G537G(BC)/G539G USE</td> </tr> <tr> <td>IR PANEL "\$"</td> <td>RED TRANSPARENT PANEL "\$" FOR G512 G519 G521 G529 G537 G539 USE</td> </tr> </tbody> </table>	ITEM NO	DESCRIPTION	BK PANEL "\$"	BLACK PANEL "\$" FOR G512B/G519B(BC)/G521B/G529B(BC)/G537B(BC)/G539B USE	GY PANEL "\$"	GRAY PANEL "\$" FOR G512G/G519G(BC)/G521G/G529G(BC)/G537G(BC)/G539G USE	IR PANEL "\$"	RED TRANSPARENT PANEL "\$" FOR G512 G519 G521 G529 G537 G539 USE
ITEM NO	DESCRIPTION																
BK PANEL "@"	BLACK PANEL "@" FOR G517B(BC)/G528B(BC) USE																
GY PANEL "@"	GRAY PANEL "@" FOR G517G(BC)/G528G(BC) USE																
IR PANEL "@"	RED TRANSPARENT PANEL "@" FOR G517(BC)/G528(BC) USE																
ITEM NO	DESCRIPTION																
BK PANEL "\$"	BLACK PANEL "\$" FOR G512B/G519B(BC)/G521B/G529B(BC)/G537B(BC)/G539B USE																
GY PANEL "\$"	GRAY PANEL "\$" FOR G512G/G519G(BC)/G521G/G529G(BC)/G537G(BC)/G539G USE																
IR PANEL "\$"	RED TRANSPARENT PANEL "\$" FOR G512 G519 G521 G529 G537 G539 USE																
 <p>PANEL-"%"</p> <table border="1" data-bbox="414 665 763 838"> <thead> <tr> <th>ITEM NO</th> <th>DESCRIPTION</th> </tr> </thead> <tbody> <tr> <td>BK PANEL "%"</td> <td>BLACK PANEL "%" FOR G535B USE</td> </tr> <tr> <td>GY PANEL "%"</td> <td>GRAY PANEL "%" FOR G535G USE</td> </tr> <tr> <td>IR PANEL "%"</td> <td>RED TRANSPARENT PANEL "%" FOR G535 USE</td> </tr> </tbody> </table>	ITEM NO	DESCRIPTION	BK PANEL "%"	BLACK PANEL "%" FOR G535B USE	GY PANEL "%"	GRAY PANEL "%" FOR G535G USE	IR PANEL "%"	RED TRANSPARENT PANEL "%" FOR G535 USE	 <p>PANEL-"#"</p> <table border="1" data-bbox="1088 642 1429 815"> <thead> <tr> <th>ITEM NO</th> <th>DESCRIPTION</th> </tr> </thead> <tbody> <tr> <td>BK PANEL "#"</td> <td>BLACK PANEL-"#" FOR G526B USE</td> </tr> <tr> <td>GY PANEL "#"</td> <td>GRAY PANEL "#" FOR G526G USE</td> </tr> <tr> <td>IR PANEL "#"</td> <td>RED TRANSPARENT PANEL "#" FOR G526 USE</td> </tr> </tbody> </table>	ITEM NO	DESCRIPTION	BK PANEL "#"	BLACK PANEL-"#" FOR G526B USE	GY PANEL "#"	GRAY PANEL "#" FOR G526G USE	IR PANEL "#"	RED TRANSPARENT PANEL "#" FOR G526 USE
ITEM NO	DESCRIPTION																
BK PANEL "%"	BLACK PANEL "%" FOR G535B USE																
GY PANEL "%"	GRAY PANEL "%" FOR G535G USE																
IR PANEL "%"	RED TRANSPARENT PANEL "%" FOR G535 USE																
ITEM NO	DESCRIPTION																
BK PANEL "#"	BLACK PANEL-"#" FOR G526B USE																
GY PANEL "#"	GRAY PANEL "#" FOR G526G USE																
IR PANEL "#"	RED TRANSPARENT PANEL "#" FOR G526 USE																

According to ISO 2768-m

Measuring DIM.=L	Tolerance	Measuring DIM.=L	Tolerance
0.5<L≤3.0 mm	±0.1 mm	30.0<L≤120.0 mm	±0.3 mm
3.0<L≤6.0 mm	±0.1 mm	120.0<L≤400.0 mm	±0.5 mm
6.0<L≤30.0 mm	±0.2 mm	400.0<L≤1000.0 mm	±0.8 mm

Recommended P.C board size for G5XX TYPE B series use

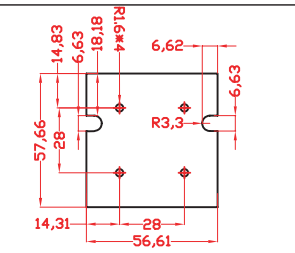
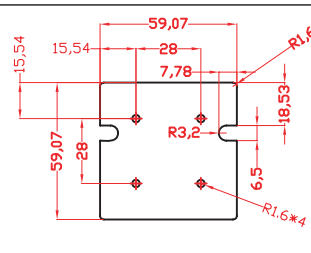
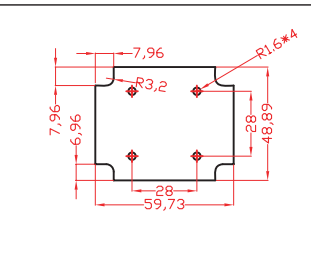
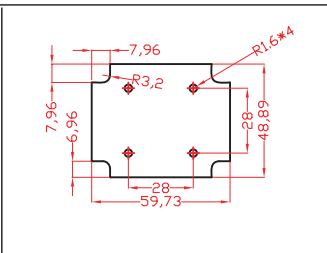
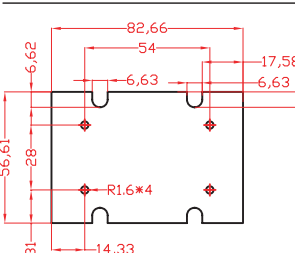
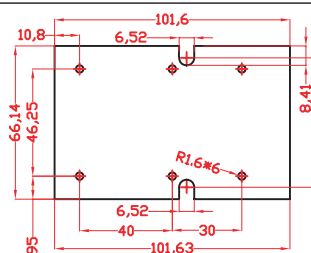
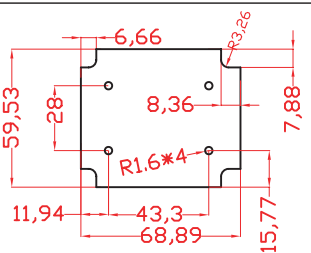
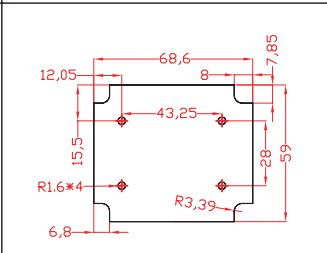
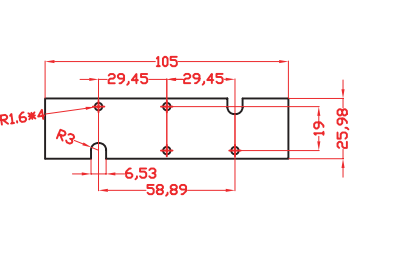
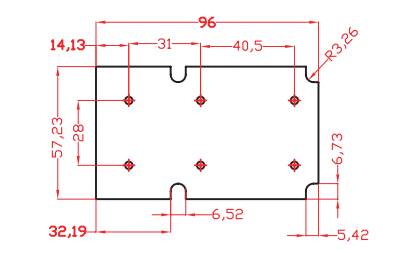
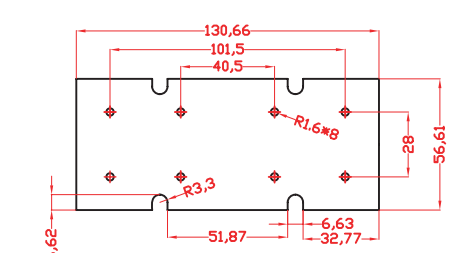
 <p>P.C BOARD SIZE FOR G512</p>	 <p>P.C BOARD SIZE FOR G515</p>	 <p>P.C BOARD SIZE FOR G517</p>	 <p>P.C BOARD SIZE FOR G519</p>
 <p>P.C BOARD SIZE FOR G521</p>	 <p>P.C BOARD SIZE FOR G526</p>	 <p>P.C BOARD SIZE FOR G528</p>	 <p>P.C BOARD SIZE FOR G529</p>
 <p>P.C BOARD SIZE FOR G535</p>	 <p>P.C BOARD SIZE FOR G537</p>	 <p>P.C BOARD SIZE FOR G539</p>	