

FEMALE

ELR-02P Housing type A

MALE

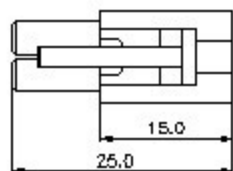
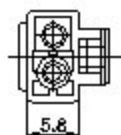
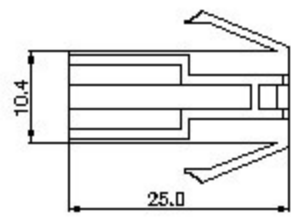

ELR-04P Housing type D

FEMALE

MALE

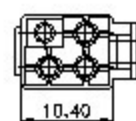
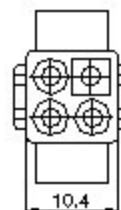
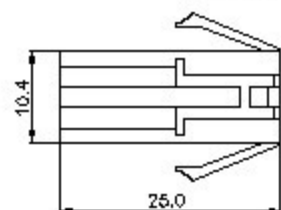

ELR-03P Housing type B

FEMALE

MALE

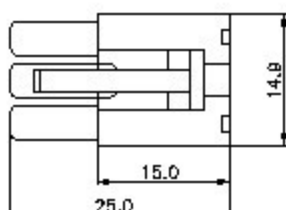
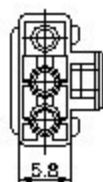
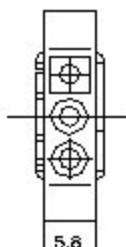
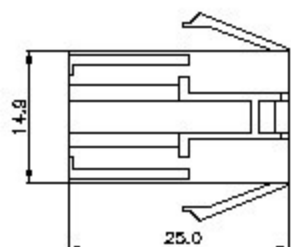

ELR-06P Housing type F

FEMALE

MALE

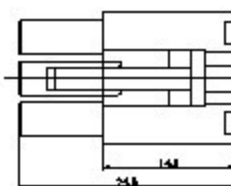
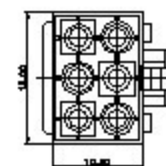
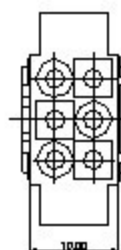
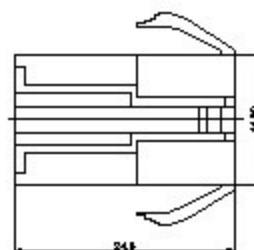

ELR-04P Housing type C

FEMALE

MALE

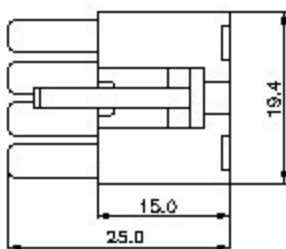
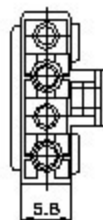
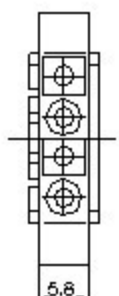
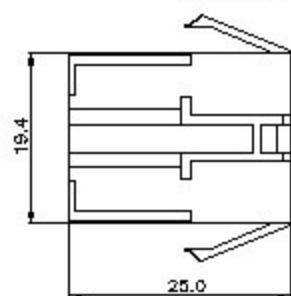

GENERAL TOLERANCE

X. ±0.60
.X ±0.38
.XX ±0.25

ANGLE TOLERANCE

X. ±5'
.X ±3'
.XX ±2'

PROJECTION

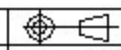

TITLE

P.C.B CONNECTOR 4.5mm EL TYPE

UNITS

mm

SHEET SIZE

A4

SERIES

DS1069-02 SERIES

DRAWING TYPE

CUSTOMER

SCALE

1:1

SHEET

2 OF 2

DRAWING NO.

C-DS1069-02-XXXXX



晨翔电子有限公司

CONNFLY CONNFLY ELECTRONIC CO. LTD

| REV. | DESCRIPTION | DRAWN | CHECKED | APPROVED |
|------|-------------|--------------|---------|----------|
| A | NEW RELEASE | LL 07/07/06' | | |
| | | | | |
| | | | | |

Female TERMINAL

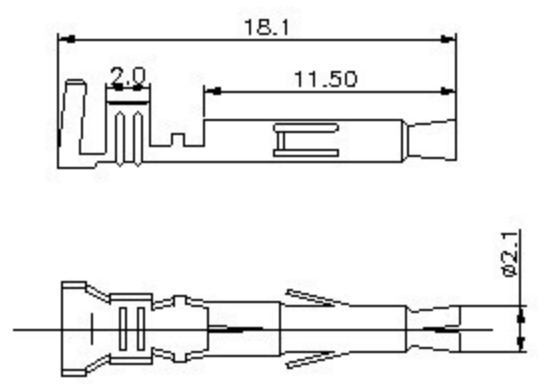

MALE Terminal

| Wire Range | | O.D of Wire |
|---------------------------------|-------|-------------|
| Section Area (mm ²) | AWG# | mm |
| 0.13~1.25 | 28~16 | 1.3~2.7 |

NOTES:

- MAIN SPECIFICATIONS
 - Housing material: NYLON 66
 - Wire range: AWG#26~#16
 - Rated voltage: 300V
 - Rated current: 1A
 - Contact resistance: $\leq 0.01\Omega$
 - Insulation resistance: $\geq 1000M\Omega$
 - Withstanding voltage: 500V,AC 1 minute
 - Temperature range: -25 ~ +85°C
 - Recommend PC board thickness:1.6~2.0mm
- PRODUCT NUMBER CODE:

DS1069-02 - X X X X X X

Housing type
 A: ELR-02P
 B: ELR-03P
 C: ELR-04P SINGLE ROW
 D: ELR-04P DUAL ROWS
 F: ELR-06P

Contact Plating
 6: Tin
 8: Full gold flash

Housing Color
 W: White
 T: Transparent
 Mounting type
 C: Crimp

Connector type
 M: Male
 F: Female
 No.of contact
 2 3 4 6

Male TERMINAL

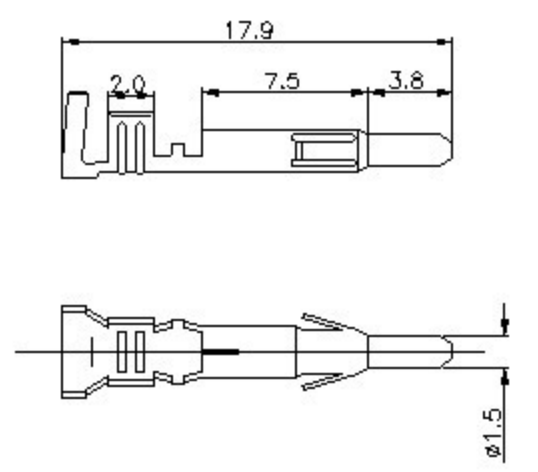

Female Terminal

| Wire Range | | O.D of Wire |
|---------------------------------|-------|-------------|
| Section Area (mm ²) | AWG# | mm |
| 0.13~1.25 | 28~16 | 1.3~2.7 |

| | | | | | | | | |
|-------------------|-------|-------------------|--------|--|----|--------|-------------------------------|--------|
| GENERAL TOLERANCE | | ANGLE TOLERANCE | | PROJECTION | | TITLE | P.C.B CONNECTOR 4.5mm EL TYPE | |
| X. | ±0.60 | X. | ±5° | UNITS | mm | | | |
| .X | ±0.38 | .X | ±3° | SHEET SIZE | A4 | SERIES | DS1069-02 | SERIES |
| .XX | ±0.25 | .XX | ±2° | 晨翔电子有限公司 CONNFLY CONNFLY ELECTRONIC CO. LTD | | | | |
| DRAWING TYPE | | CUSTOMER | | | | | | |
| SCALE | 1:1 | SHEET | 1 OF 2 | | | | | |
| DRAWING NO. | | C-DS1069-02-XXXXX | | | | | | |