

BN 11904 - DIN 7504

Octagon socket pan head self-drilling screws
 ~type N
 case-hardened

DIN 7504

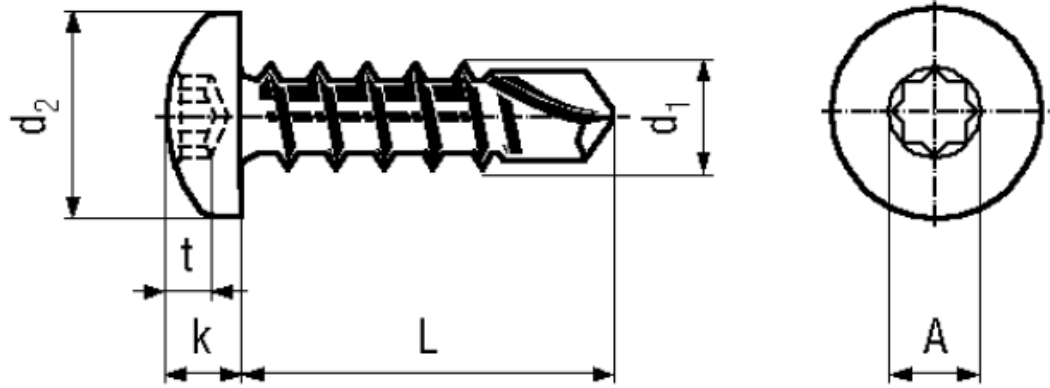

Trade mark	eco-drill™	Surface	zinc plated blue
Material	Steel	Hardness	560 HV

Article No. - 3060679

d_1	ST 3,5
L	13
d_2 max.	6,9
k max.	2,8
Internal octagon	1
t max.	1,75
A~	3,2

DIN 7504: Standard withdrawn

Shaped drilling head.

.....