

# Series AMEOR30C-AZ

up to 2.5A | AC-DC / DC-DC LED driver

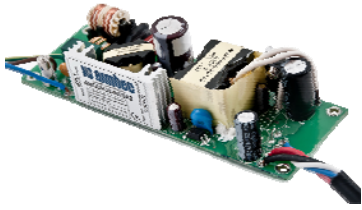

## FEATURES:

- AC-DC Constant current LED Driver
- Input range 90-305VAC/47-440Hz
- High Efficiency up to 86%
- Operating temperature -40 to 80°C
- Dimmable via Analog / 0-10Vdc / PWM
- Over Temperature Protection
- Open frame
- Power Factor Correction
- SCP, Over Current Protection
- 5 Year Limited Warranty

## Models Single output



Model	Max Output Power (W) *	Output Voltage Range (V)	Output Current (A)	Input Voltage (VAC/Hz)	Input Voltage (VDC)	Efficiency (%)
AMEOR30C-5070AZ	35	36-50	0.7	90-305/47-440	130-430	86
AMEOR30C-4864AZ	30.72	36-48	0.64	90-305/47-440	130-430	86
AMEOR30C-36100AZ	36	24-36	1	90-305/47-440	130-430	85
AMEOR30C-24140AZ	33.6	12-24	1.4	90-305/47-440	130-430	84
AMEOR30C-12250AZ	30	5-12	2.5	90-305/47-440	130-430	83

\*Exceeding the maximum output power will permanently damage the converter

All models can be ordered with optional North American colour input wires (black (L), white (N), green (GND)). Add “-NA” to part number when ordering.

NOTE: Aimtec limited warranty of 5 years is valid based on product operation at datasheet specifications at ambient temperature of 25°C, humidity<75%, nominal input voltage (115/230/305VAC) and at rated output load unless otherwise specified. See

<http://www.aimtec.com/terms-sale>

AMEOR30C-AZ's AC/DC LED drivers have electrical safeguards designed within to protect it from conventional electrical abnormalities with the levels listed in the safety table. Applications for use within rural agricultural, heavy industrial, and other areas or regions which are prone to 'dirty' electrical conditions which would subject any of the above models to excessive voltages surges or spikes, may damage or cause early life failure of product. In this case consideration should be made by the end user to ensure that adequate line or mains surge suppression is installed in front of Aimtec device to ensure the longevity of the products. Failure to identify excessive line surges violations prior to installation may damage sensitive equipment permanently.

## Input Specifications

Parameters	Conditions	Typical	Maximum	Units
Inrush current <2ms	115VAC	25		A
	230VAC	40		
Leakage current	115VAC	0.3		mA
	230VAC	0.5		
AC current	115VAC	0.33		A
	230VAC	0.16		
Power Factor	115VAC		0.99	
	230VAC		0.97	
External fuse			250V/1A	
Start up time		450		ms
Surge voltage	2sec		440	V

## Output Specifications

Parameters	Conditions	Typical	Maximum	Units
Current accuracy		±3		%
Line regulation	LL-HL	±1		%
Load regulation	0-100% load	±3		%
Ripple & Noise *	20MHz Bandwidth	75		mV p-p
Hold-up time		50		ms
Current adjustment range		100-0		%
Minimum Load Voltage	See the models table			

\* Tested with 0.1µF (M/C) or (C/C) and 47µF (E/C) parallel capacitors at the end.

### Isolation Specifications

Parameters	Conditions	Typical	Rated	Units
Tested I/O voltage	60 sec		3000	VAC
Isolation Resistance		>1000		MΩ

### General Specifications

Parameters	Conditions	Typical	Maximum	Units
Switching frequency		130		KHz
Over current protection	AMEOR30C-5070AZ		0.77	A
	AMEOR30C-4864AZ		0.68	
	AMEOR30C-36100AZ		1.04	
	AMEOR30C-24140AZ		1.45	
	AMEOR30C-12250AZ		2.55	
Over voltage protection	Refer to Constant Current vs. Constant Voltage Mode curve			
Short circuit protection	Continuous			
Short circuit restart	Auto recovery			
Over temperature protection	>105°C			
Operating temperature	With derating over 60°C	-40 to +80		°C
Maximum case temperature			100	°C
Storage temperature		-40 to +95		°C
Temperature coefficient		±0.02		% / °C
Cooling	Free air convection			
Humidity			95	% RH
Wires	UL1015 18AWG * 20CM			
Weight	220			g
Dimensions (L X H X W)	5.83 x 1.97 x 1.3 inches		148 x 50 x 33 mm	
MTBF	>400,000 hrs (MIL-HDBK-217F at +25°C)			

### Environment Approval

Test	Parameters	Conditions
Shock	Wave form	Half sine wave
	Acceleration amplitude	5gn
	Bump duration	30 ms
	Converter operation	Before and after test, body mounted (on chassis)
	Number of bumps	18 (3 in each direction for every axis)
Vibration	Test mode	Sweep sine, 10-100Hz, speed 0.05Hz/s
	Displacement	1 mm
	Acceleration	3g, 3 loops 30min one cycle, 3h total, every axis tested
	Converter operation	Before and after test, body mounted (on chassis)

### Safety Specifications

Parameters		
Agency approvals	cULus, CE	
Standards	UL8750, UL60950-1, EN55022, class B	
	Information Technology Equipment	EN55022 Class B
	Harmonic Current Emissions	IEC/EN 61000-3-2, Class C
	Voltage fluctuations and flicker	IEC/EN 61000-3-3, (EN60555-3)
	Electrostatic Discharge Immunity	IEC 61000-4-2 Level 3
	RF, Electromagnetic Field Immunity	IEC 61000-4-3 Level 2
	Electrical Fast Transient / Burst Immunity	IEC 61000-4-4 Level 2
	Surge Immunity	IEC 61000-4-5 Level 3
	RF, Conducted Disturbance Immunity	IEC 61000-4-6 Level 2
	Power frequency Magnetic Field Immunity	IEC 61000-4-8 Level 1
	Voltage dips, Short Interruptions Immunity	IEC 61000-4-11

### Dimensions

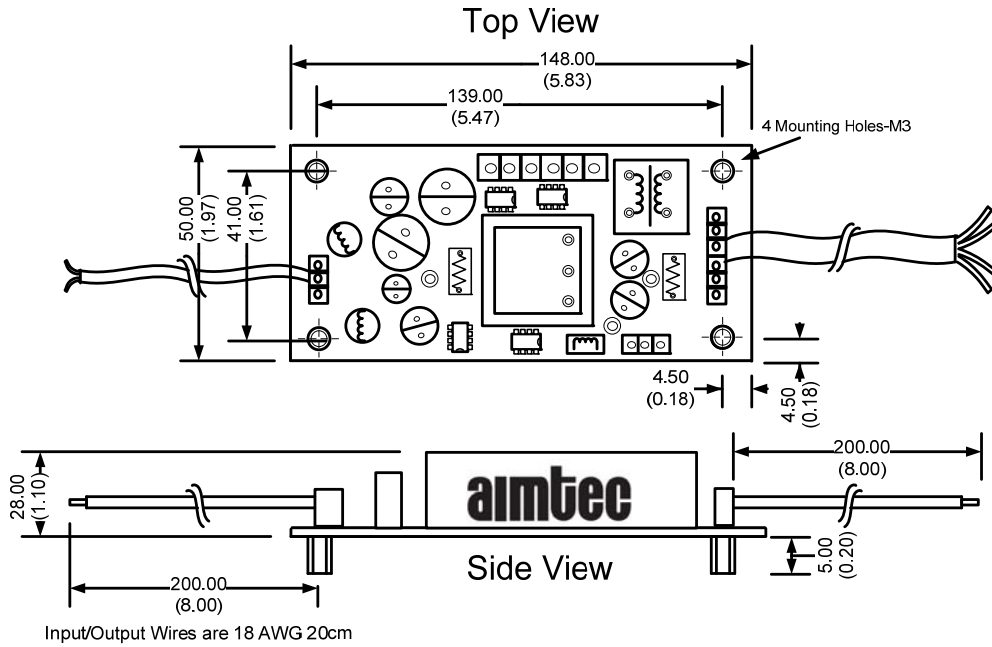

**NOTE:** to adjust the output current connect a 20K Ohm pot between blue and white wire

### Wire connection:

Wire	Connection
Brown	AC L
Blue	AC N
Green	Ground
Red	+V output
Black	-V Output
Blue (Dimming)	+ Vs dimming
White (Dimming)	-Vs dimming

### Application Circuit

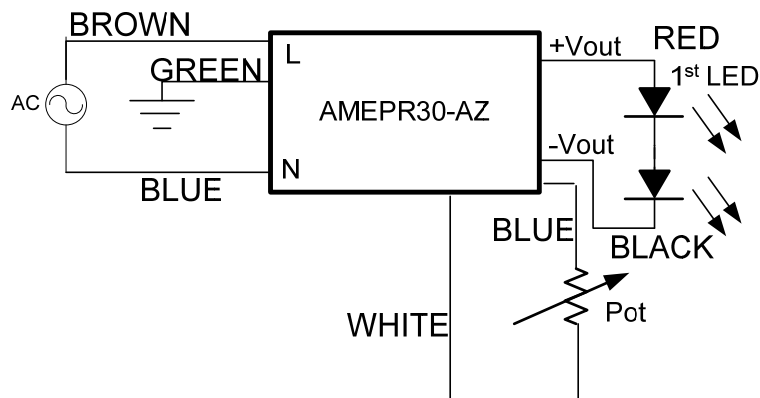

Model Number	Maximum Pot Value (kΩ)
AMEPR30-5070AZ	9.00
AMEPR30-4864AZ	9.00
AMEPR30-36100AZ	9.00
AMEPR30-24140AZ	26.00
AMEPR30-12250AZ	26.10

Temperature graph

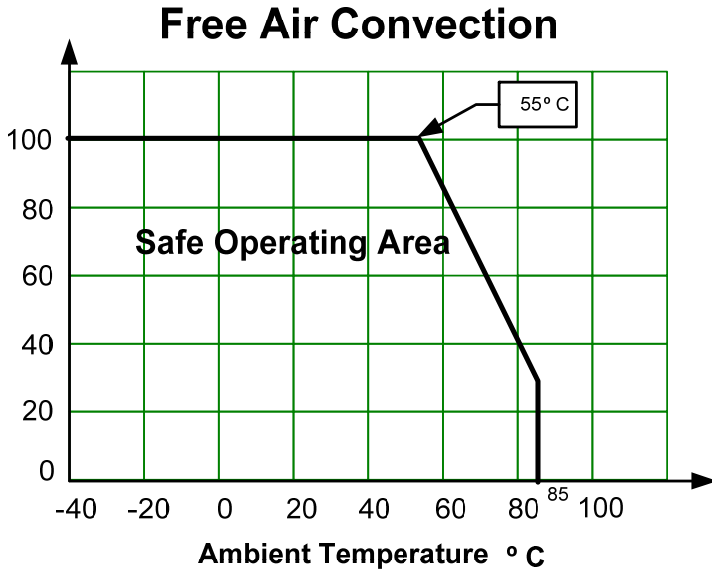

Efficiency Vs. Input Voltage & Output Current (Constant current load)

AMEOR30C-5070AZ

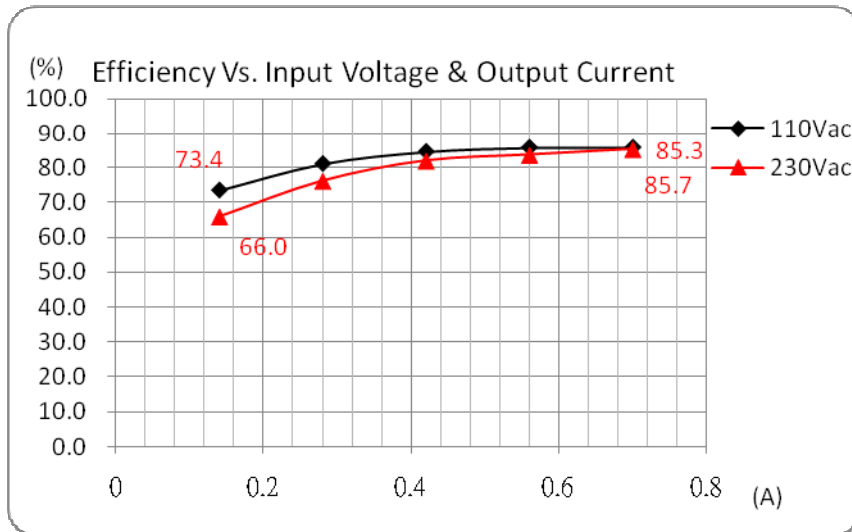

**AMEOR30C-4864AZ**

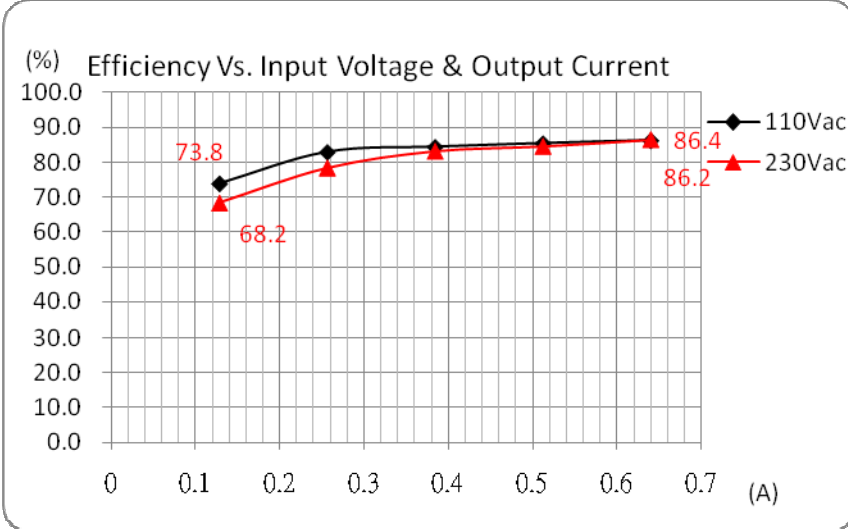

**AMEOR30C-36100AZ**

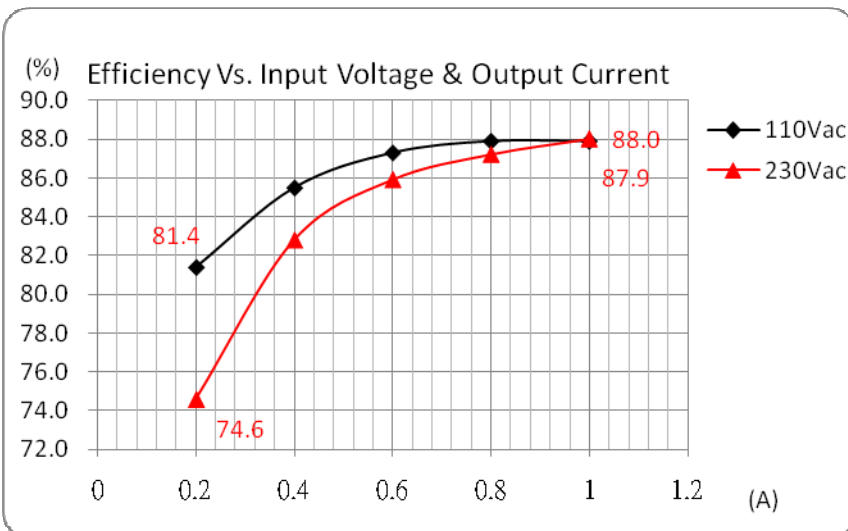

**AMEOR30C-24140AZ**

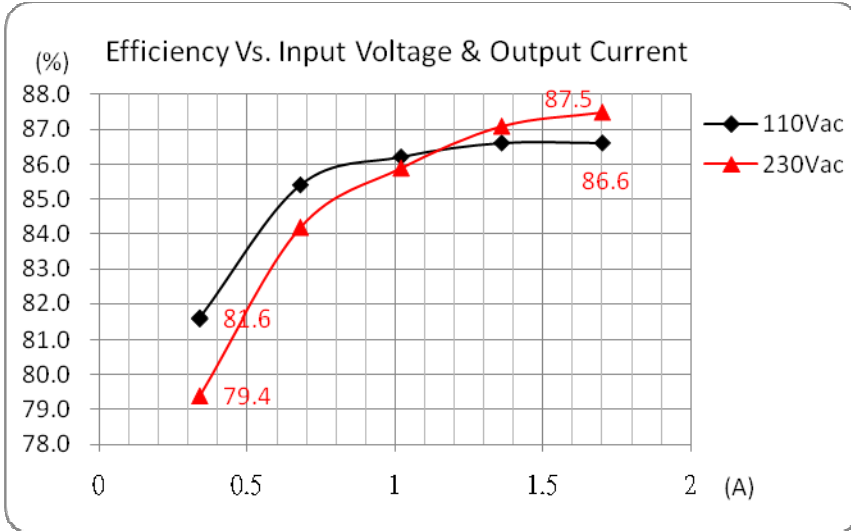

**AMEOR30C-12250AZ**

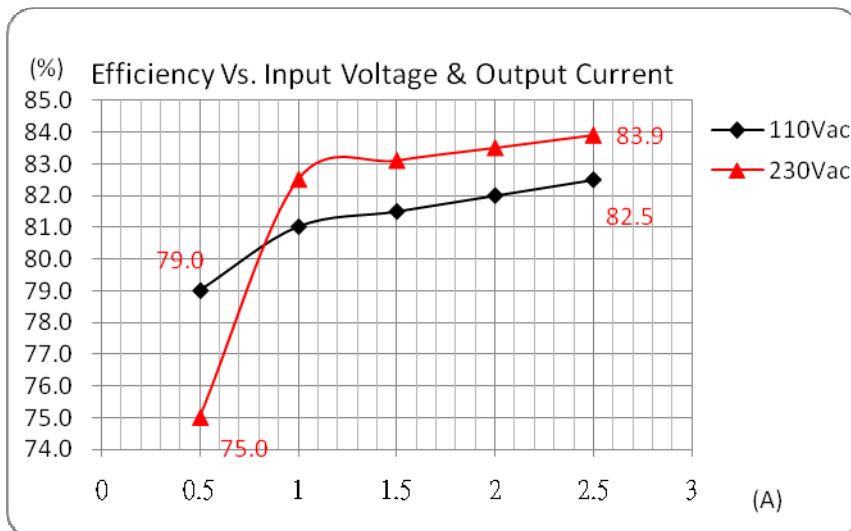

**PFC Value vs. Output Load Current (constant current mode)**

**AMEOR30C-5070AZ**

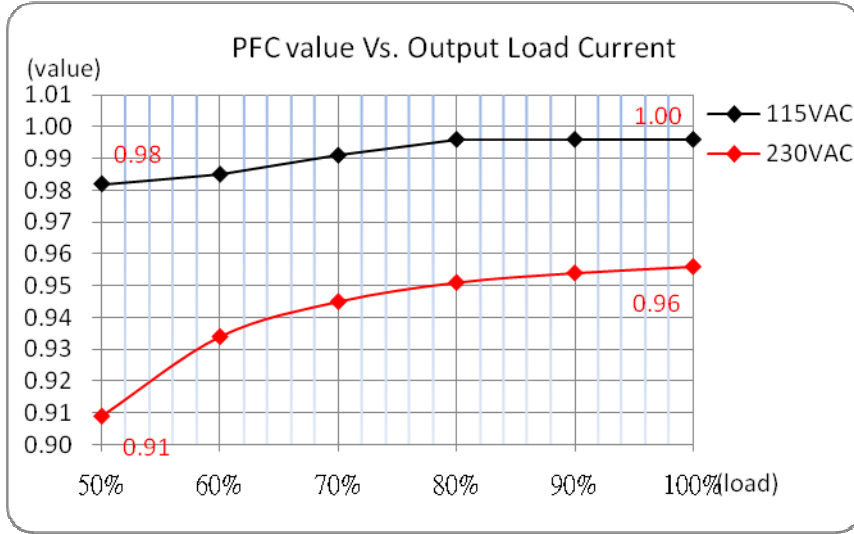

**AMEOR30C-4864AZ**

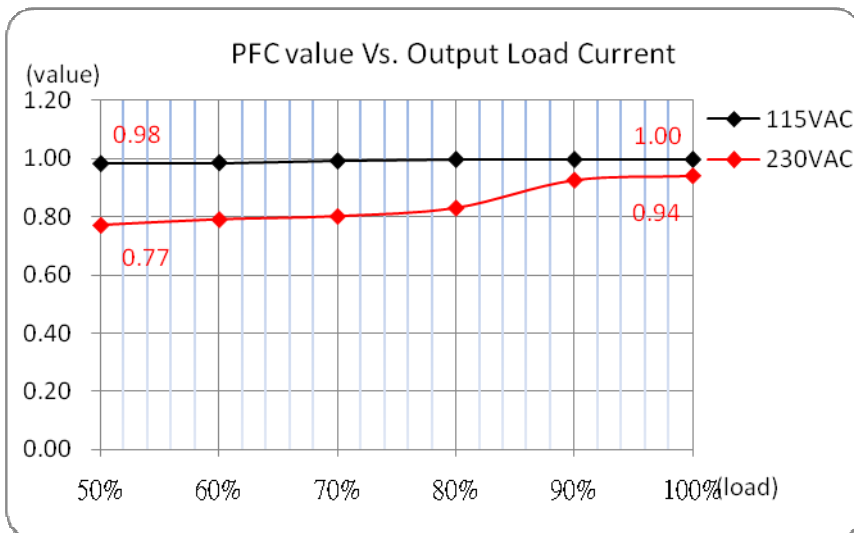

**AMEOR30C-36100AZ**

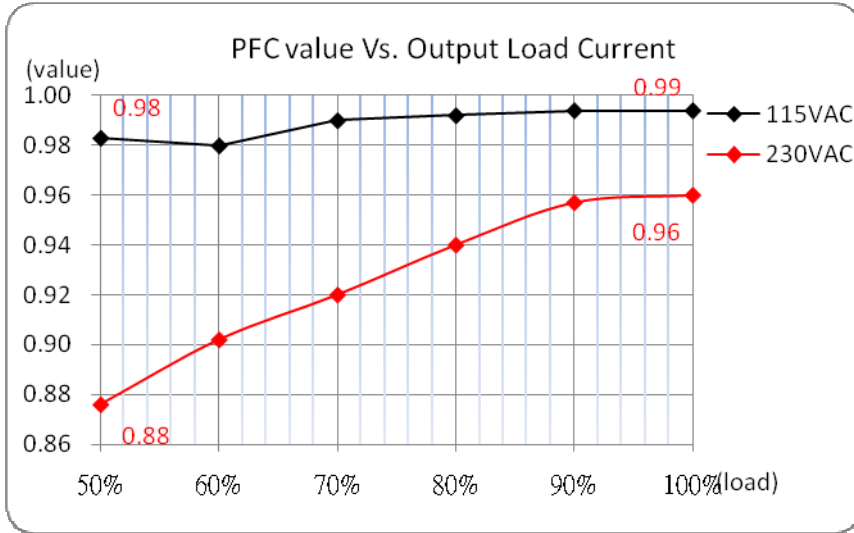

**AMEOR30C-24140AZ**

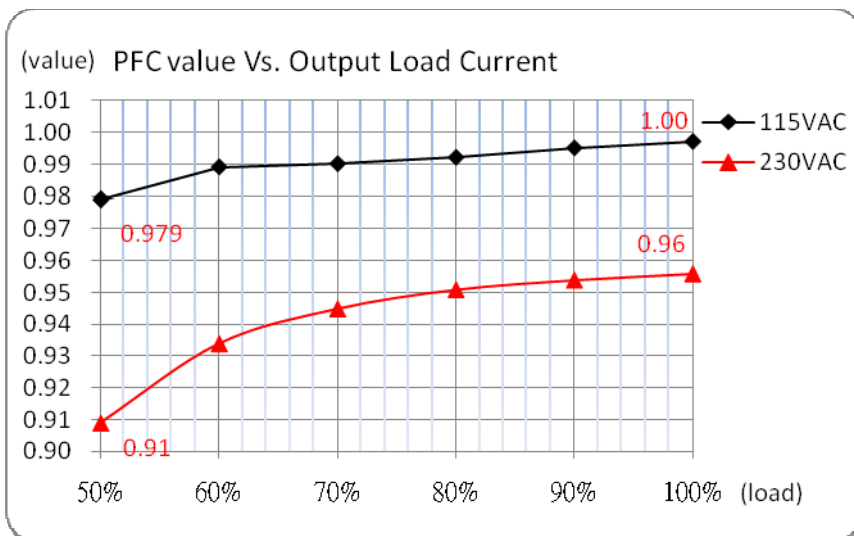



**AMEOR30C-12250AZ**

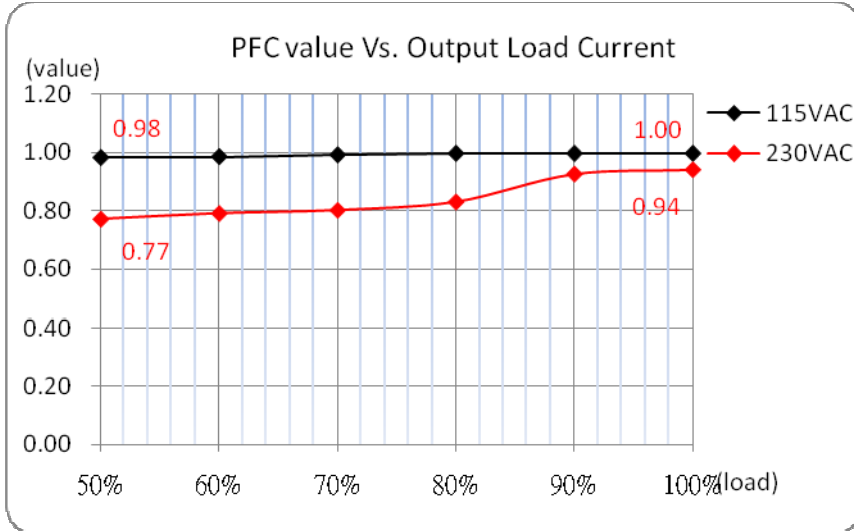

**Constant Current vs. Constant Voltage Mode**

**AMEOR30C-5070AZ**

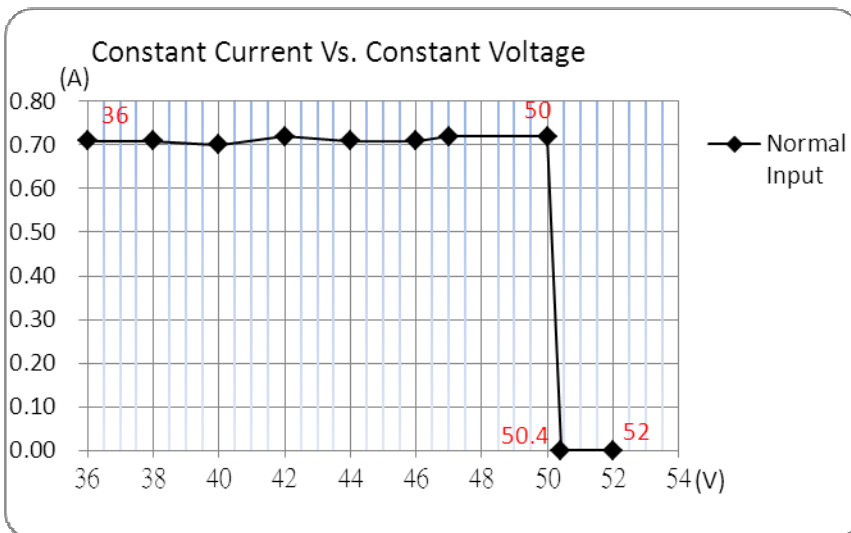

**AMEOR30C-4864AZ**

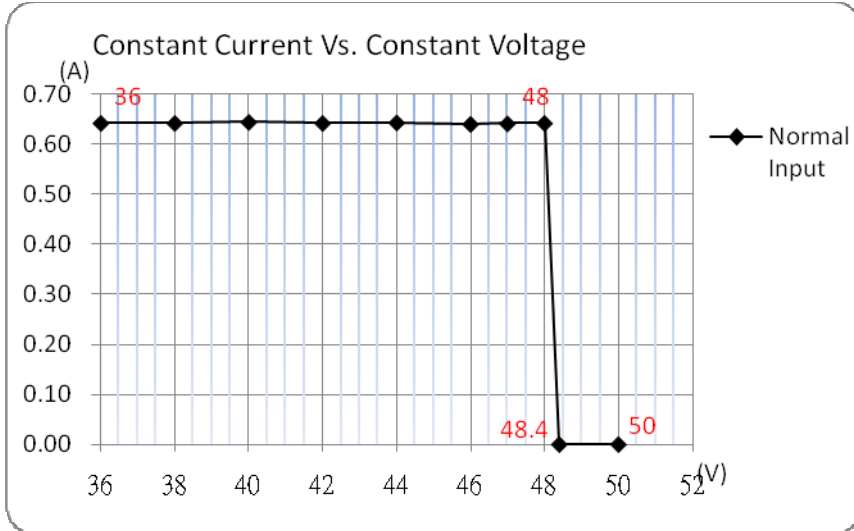

**AMEOR30C-36100AZ**

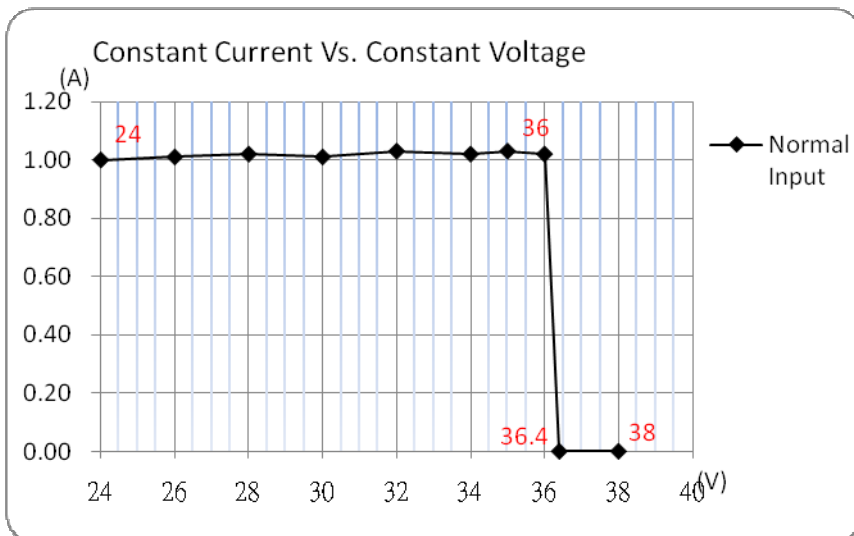

**AMEOR30C-24140AZ**

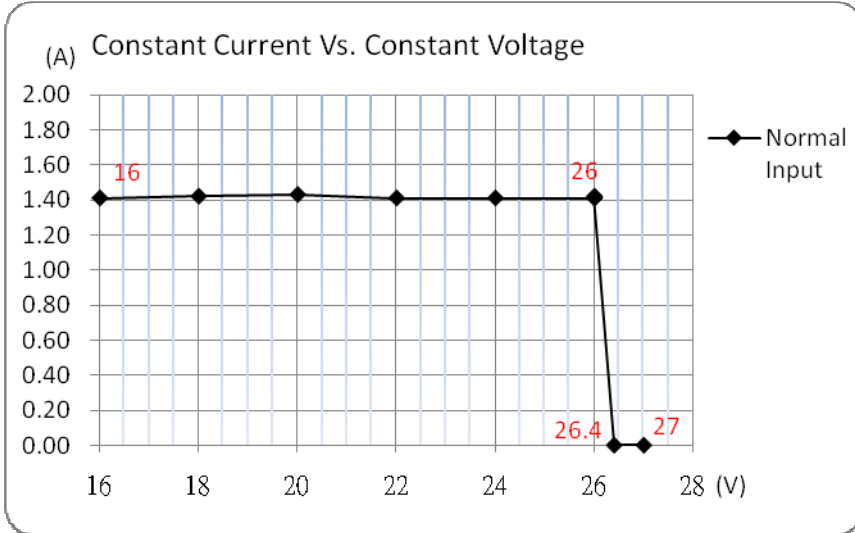

**AMEOR30C-12250AZ**

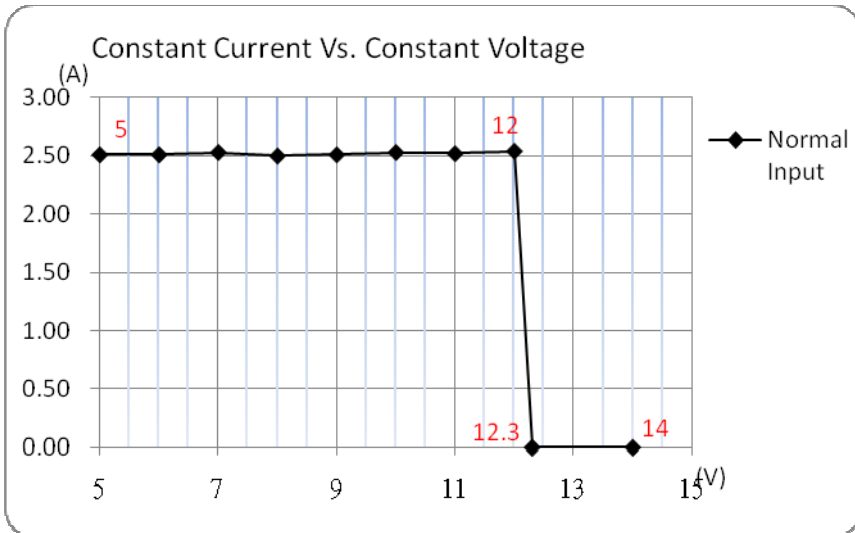

**Dimming Performance Graphs**  
**AMEOR30C-4864AZ**

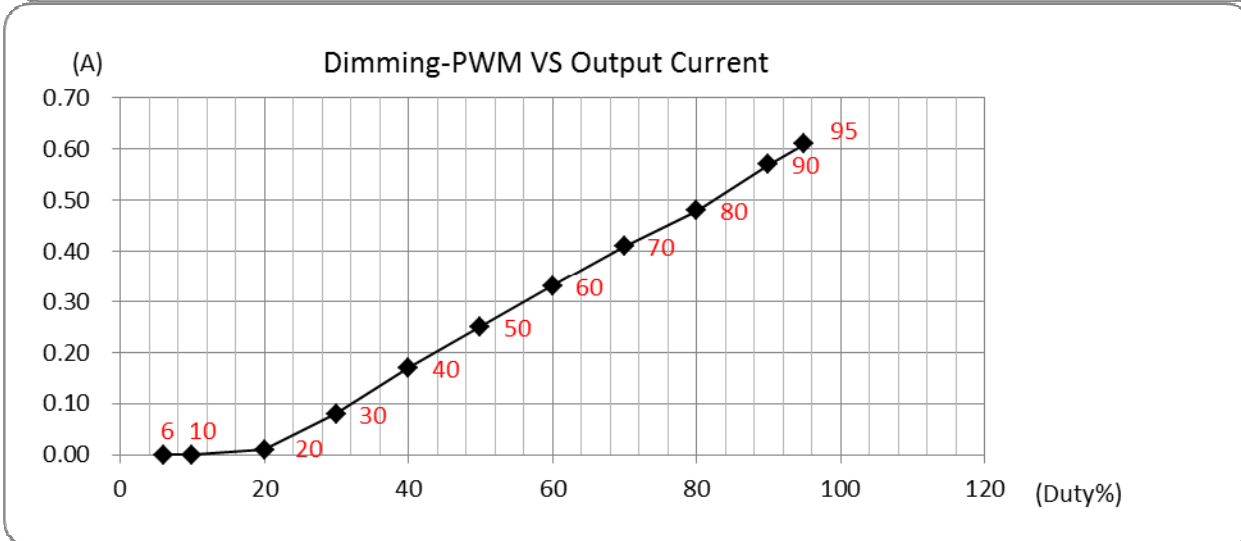
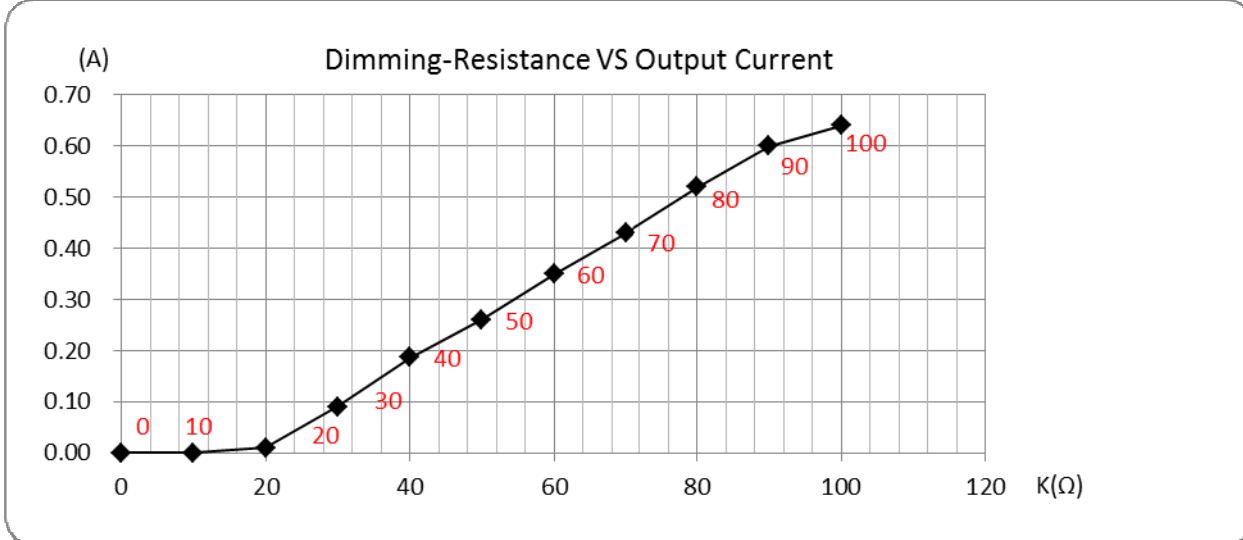

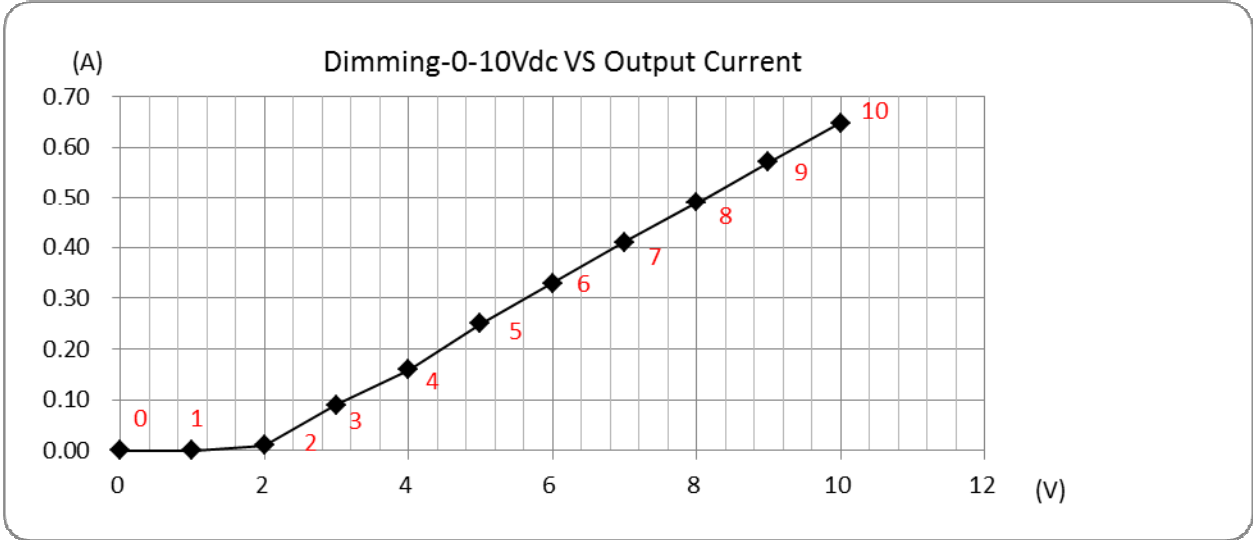

**AMEOR30C-5070AZ**

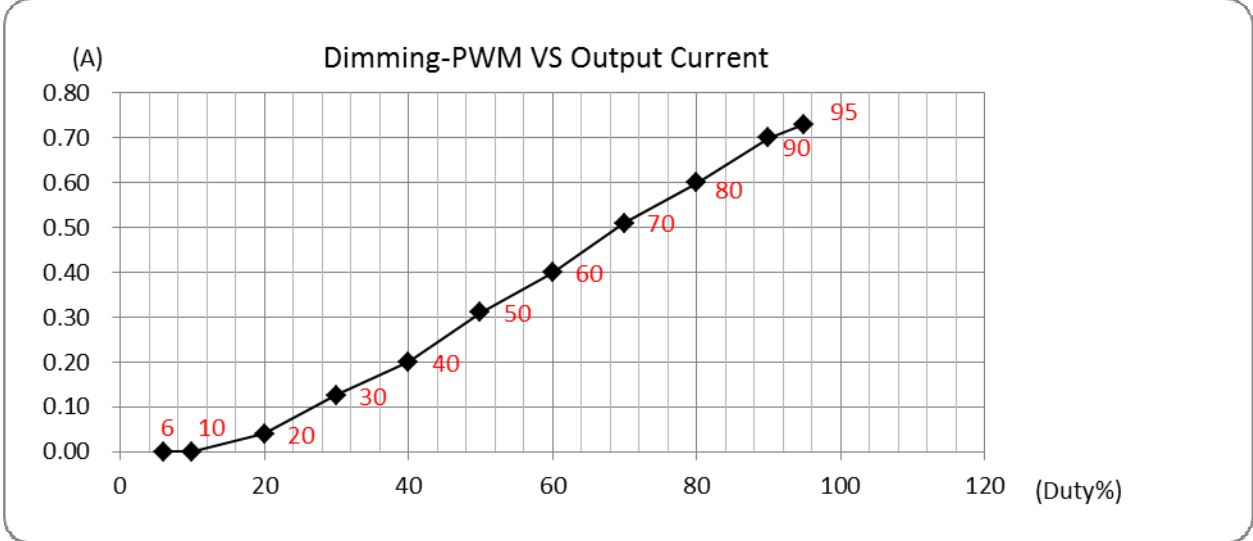
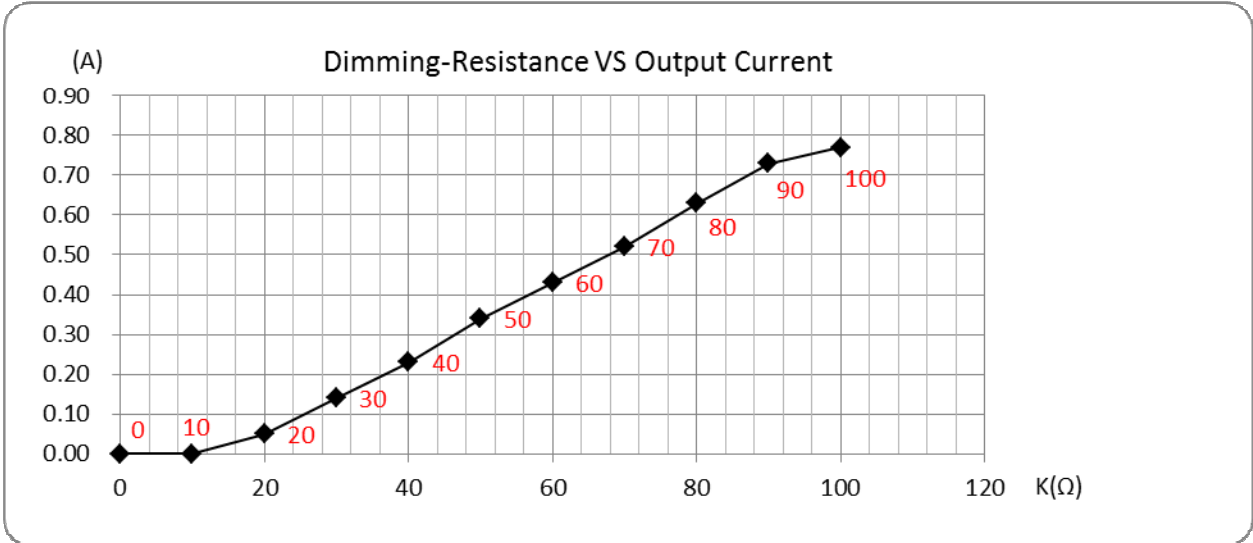

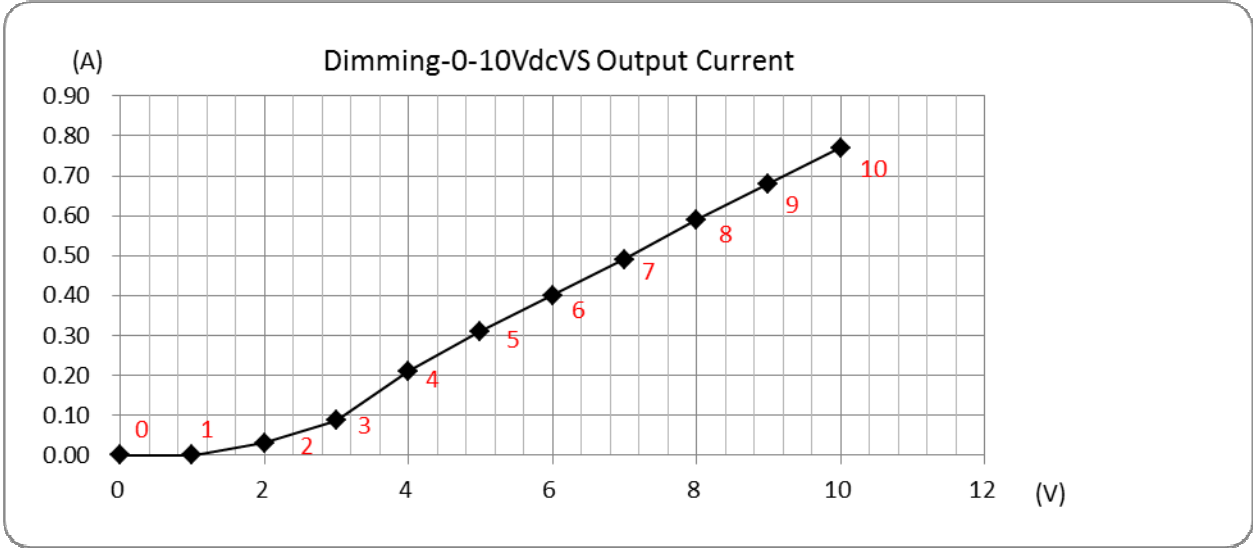

**AMEOR30C-12250AZ**

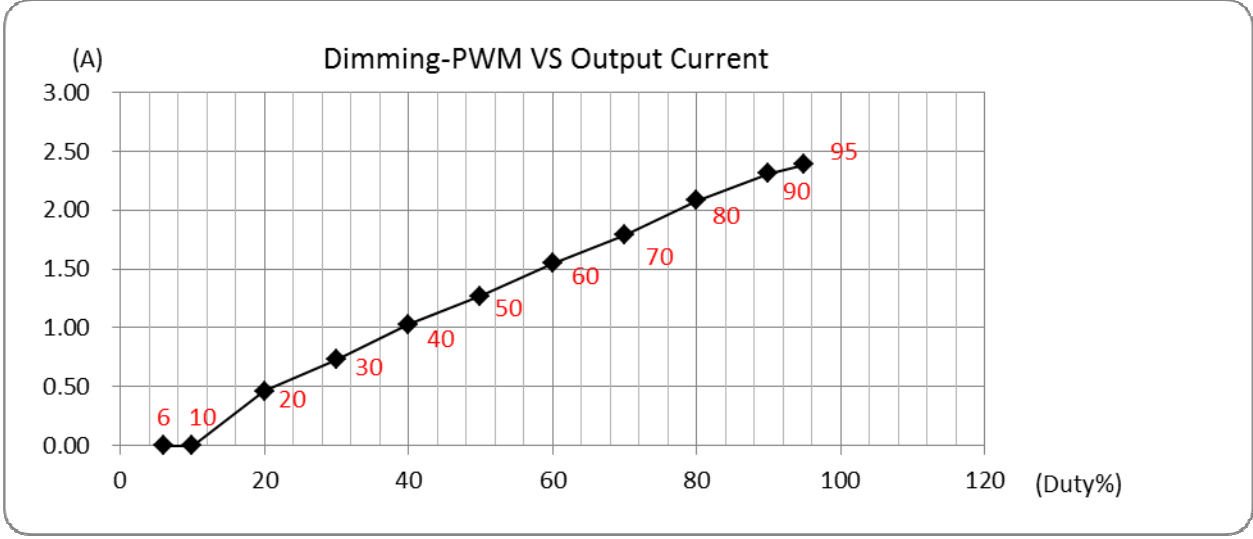
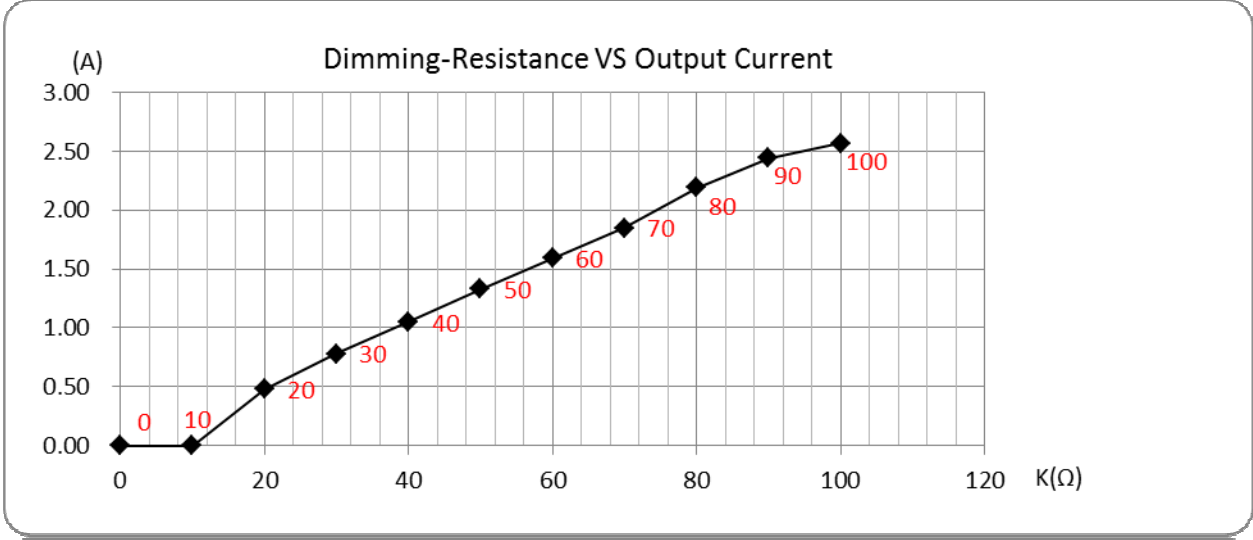

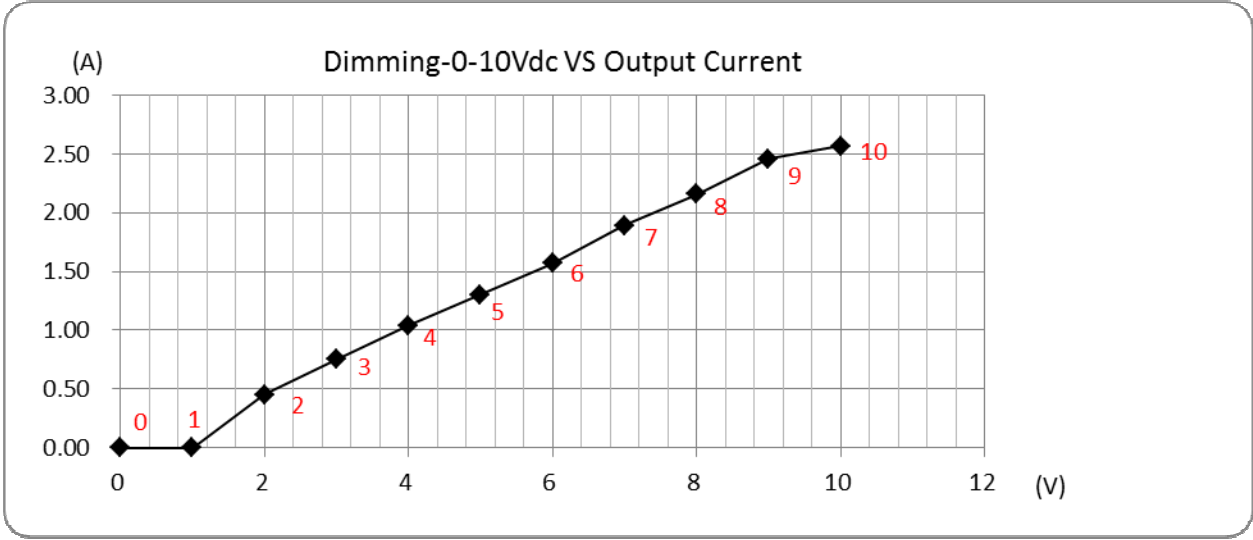

**AMEOR30C-24140AZ**

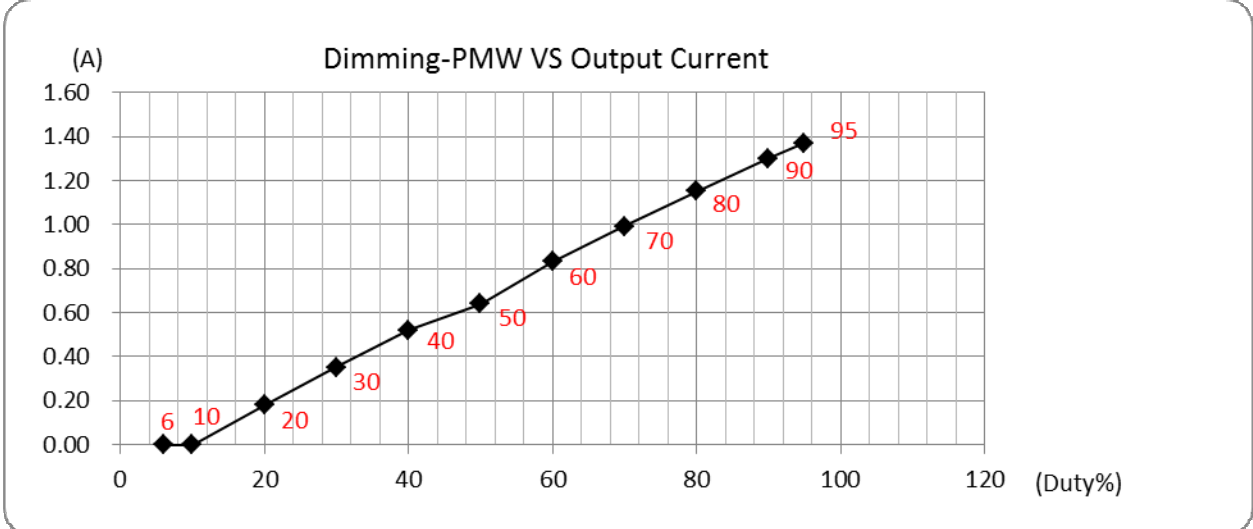
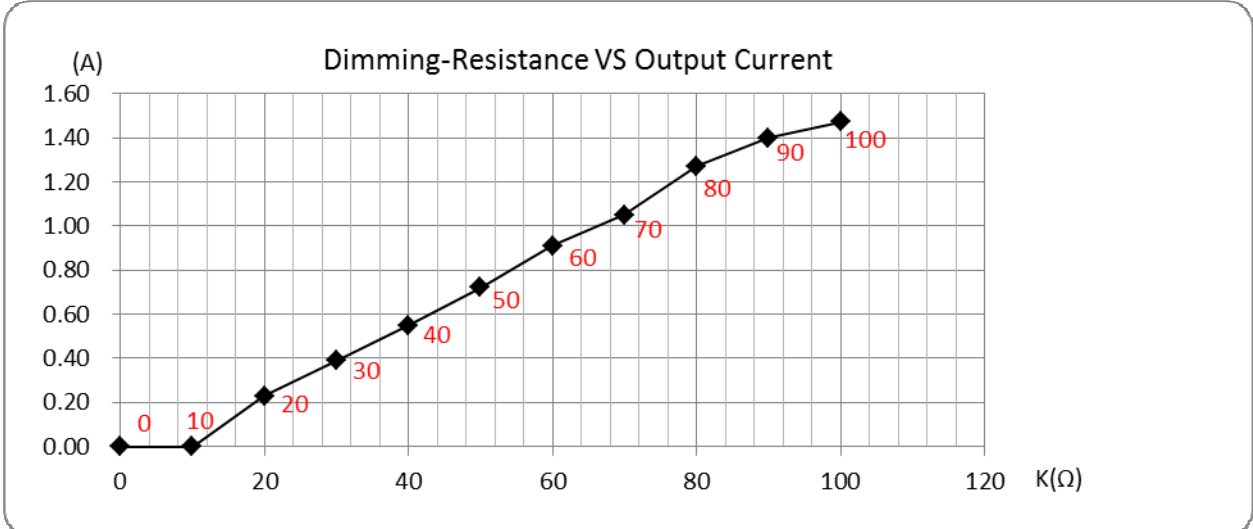

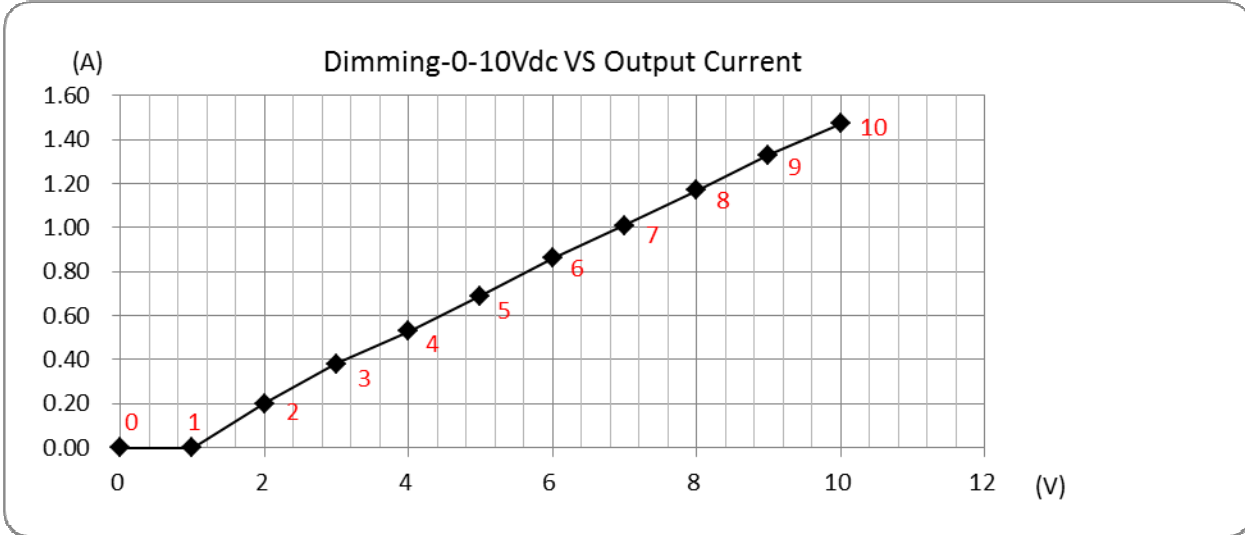

**AMEOR30C-36100AZ**

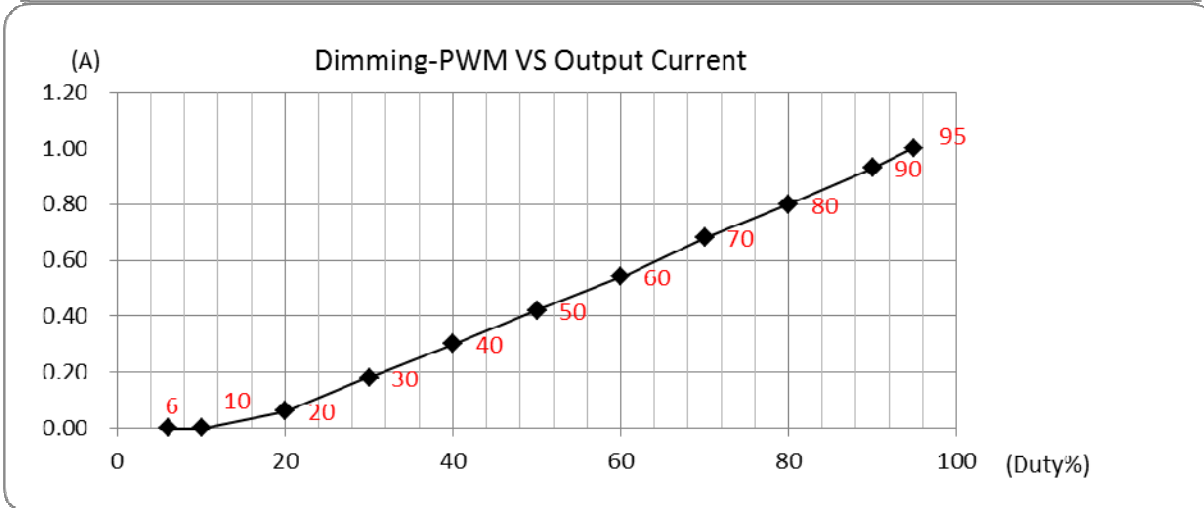
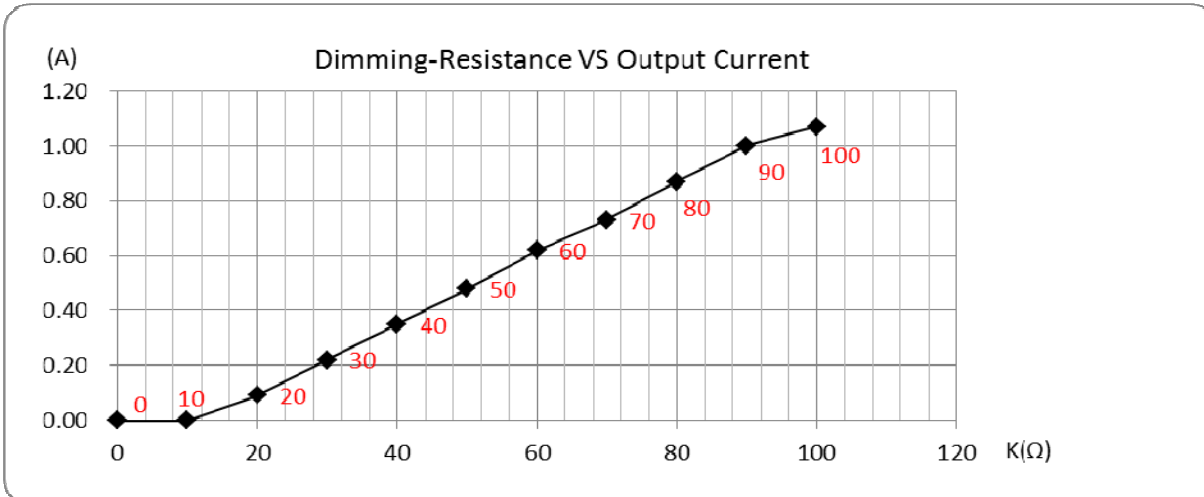



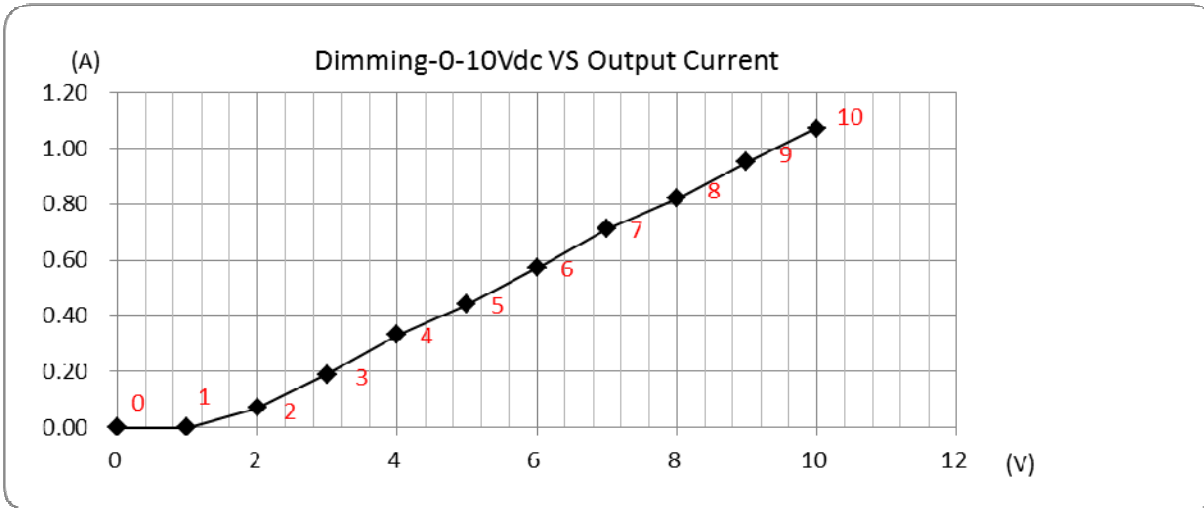

**NOTE:** **1.** Datasheets are updated as needed and as such, specifications are subject to change without notice. Once printed or downloaded, datasheets are no longer controlled by Aimtec; refer to [www.aimtec.com](http://www.aimtec.com) for the most current product specifications. **2.** Product labels shown, including safety agency certifications on labels, may vary based on the date manufactured. **3.** Mechanical drawings and specifications are for reference only. **4.** All specifications are measured at an ambient temperature of 25°C, humidity<75%, nominal input voltage and at rated output load unless otherwise specified. **5.** Aimtec may not have conducted destructive testing or chemical analysis on all internal components and chemicals at the time of publishing this document. CAS numbers and other limited information are considered proprietary and may not be available for release. **6.** This product is not designed for use in critical life support systems, equipment used in hazardous environments, nuclear control systems or other such applications which necessitate specific safety and regulatory standards other the ones listed in this datasheet. **7.** Warranty is in accordance with Aimtec's standard Terms of Sale available at [www.aimtec.com](http://www.aimtec.com).