



Catalog | 2013

# System pro *E* comfort MISTRAL65

## Transparency, depth, space



# Index

|  |    |
|--|----|
| A point of reference. For simplicity and effectiveness | 2  |
| A point of arrival. For functions and applications     | 4  |
| A point of view. Never seen before                     | 6  |
| A point of contact with the world of ABB               | 8  |
| A point of departure for made-to-measure solutions     | 10 |
| Order codes  | 12 |
| Terminal blocks  | 21 |
| Technical details                                      | 22 |
| Upper and lower knockouts                              | 25 |
| Overall dimensions                                     | 26 |
| List of quick reference codes                          | 29 |

A point of reference. For simplicity and effectiveness  
A complete series, versatile and easy to install

Efficiency, safety, integration: the new System pro *E* comfort MISTRAL65 series rests on the strengths which have consolidated ABB's image over the years for its expertise and reliability in the area of products for protection, control, monitoring, measurement, safety and energy efficiency. These innovative IP65 rated consumer units complete ABB's wide product range for the industrial sector.

The result of constant research and constant attention paid to technological development, the System pro *E* comfort MISTRAL65 series consumer units are designed to satisfy all requirements electrical installers might have.

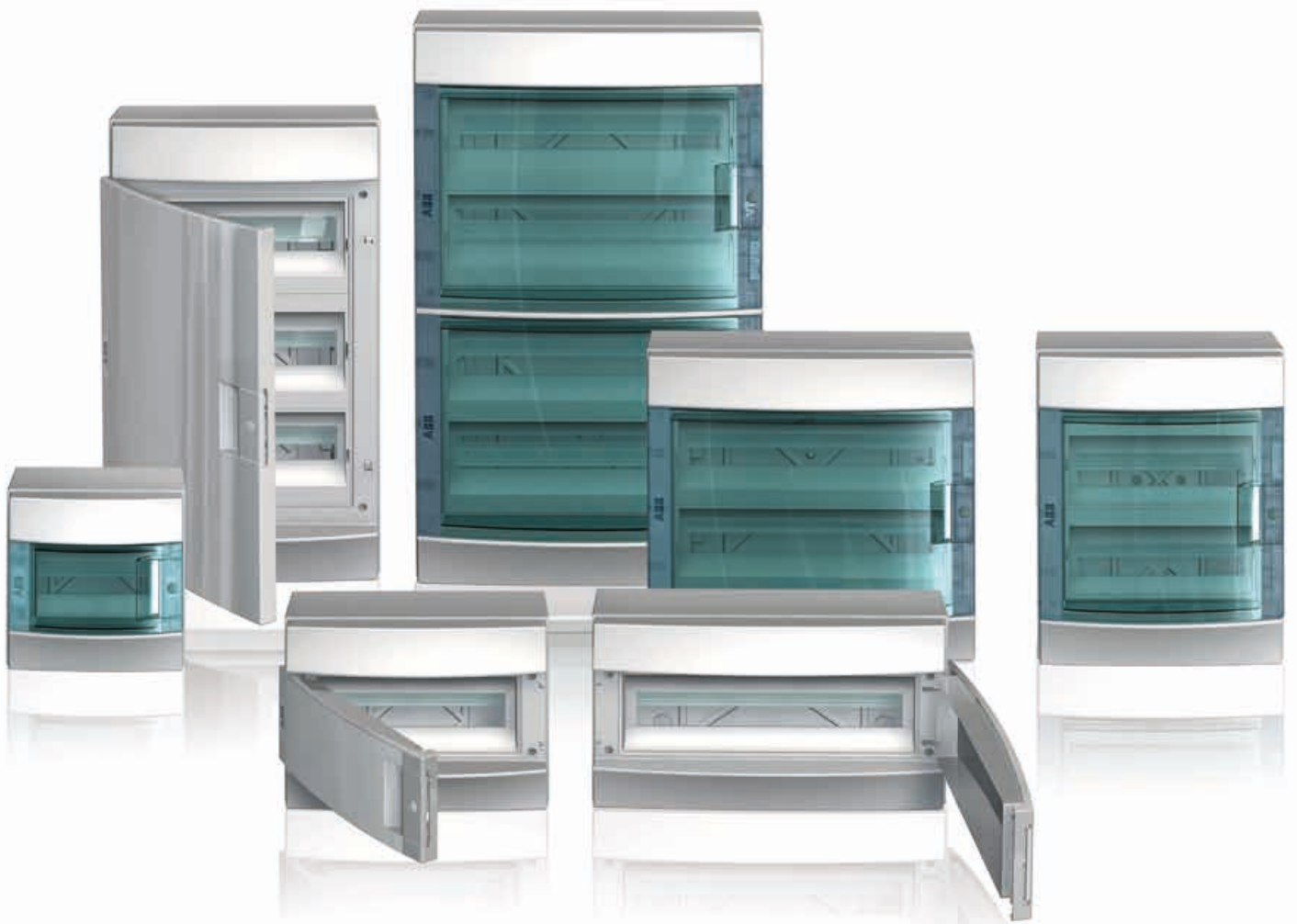

The new range of System pro E comfort MISTRAL65 consumer units allows almost any type of electrical distribution system to be implemented in industrial, commercial and residential environments. The consumer units are manufactured in a halogen-free thermoplastic which is completely recyclable. The range includes solutions with transparent or opaque doors which open up to 180°, and a choice of between 4 and 72 modules, meeting the most recent regulatory requirements and ensuring an enormous variety of application types are covered. The refined design is marked by some particular characteristics, for example the perfect symmetry, which allows either the whole consumer unit or just the front panel to be rotated, easily changing the door opening side.

In the multi-row versions, the centre distance of the DIN rails can be varied from 150 mm to 125 mm, further increasing the versatility of the product and using the same standard accessories.

The frame is extractable for quick and easy bench cabling. The ample internal space makes the cables more accessible, facilitating cabling and giving the possibility to anchor the cable-ties to special eyeholes on the frame.

The consumer units are designed to house optional dedicated terminal blocks in two different colour schemes to allow quick and tidy cabling, and making separate power supplies easily recognisable, when used.

The range is completely coordinated with ABB MCBs and MCCBs, all of which can be easily installed simply by moving the rail provided for their housing.

The project design also aimed to optimise cabling, assembly and installation times of the consumer units.

Everything has been designed to make the installer's job quicker and easier, allowing them to implement functional and tidy switchboards.



Innovating today does not just mean looking for functional and technologically advanced solutions. For ABB, being innovative means embracing a longer-term perspective by using eco-compatible materials for our products which respect the environment even at the end of their life cycle. For this reason, 100% recyclable halogen-free thermoplastics have been used for the consumer units.

Their environmental compatibility has been assessed using the Life Cycle Assessment (LCA) method, an objective tool for analysing energy and environmental impact which analyses the energy and materials used and the emissions released during production.

# A point of arrival. For functions and applications The benefits of a product range designed to last

The 180° door opening facilitates total accessibility to the interior of the consumer unit

The minimalistic simplicity of the new design combines technological reliability with the most innovative aesthetic trends

The decorative texture of the door underlines the attention to detail and the quality of the finish

The transparent door in the exclusive new petrol blue colour ensures an elegant and original look

The perfect symmetry of the front allows the opening to be completely reversed

The door has an ergonomic handle with snap-on closing or a lock (optional)

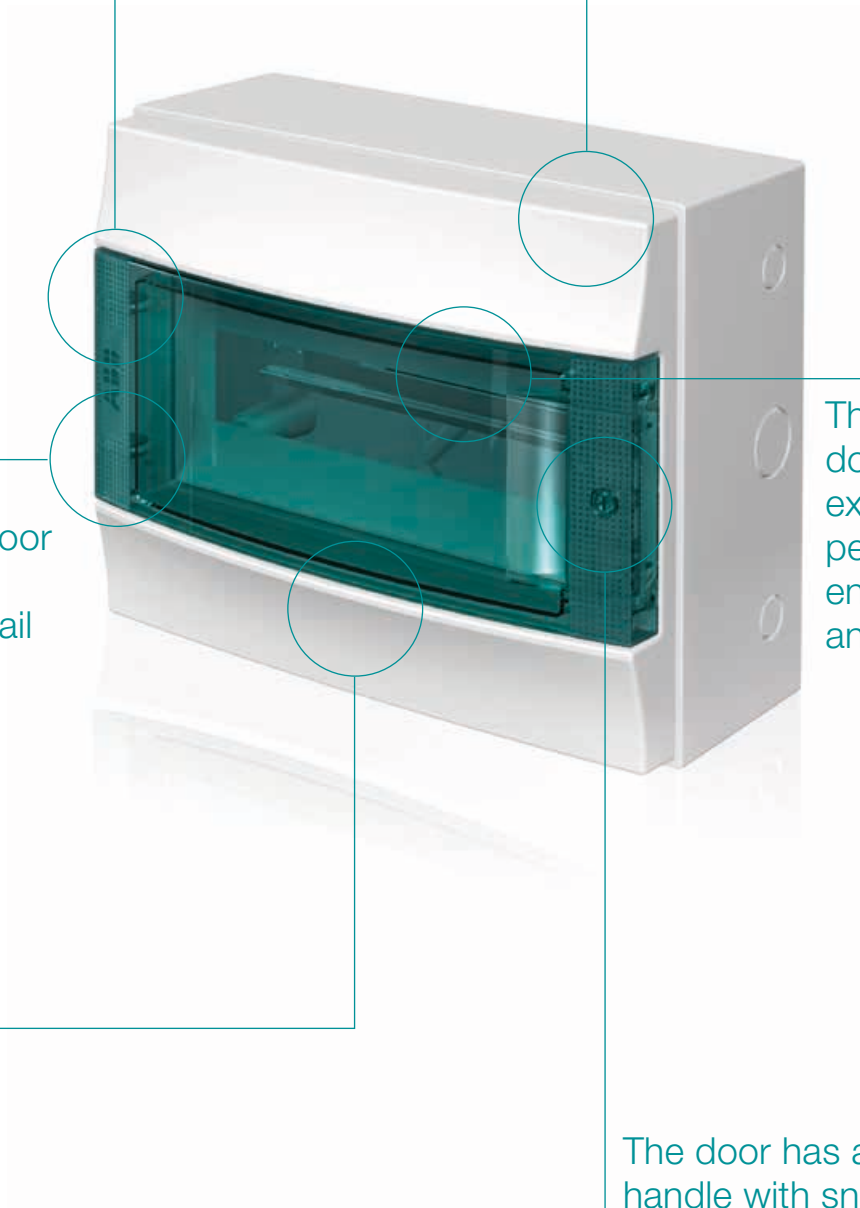

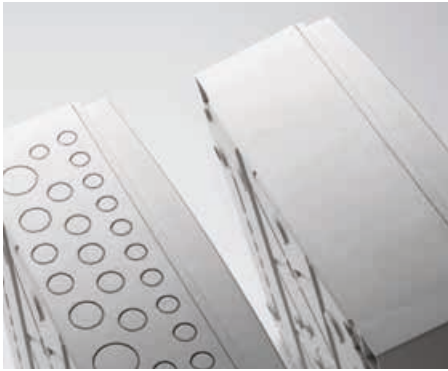

Aside from a series of side knockouts for cable entry and exit, the consumer units can be supplied, on request, with cable entries and exits both at the top and bottom.

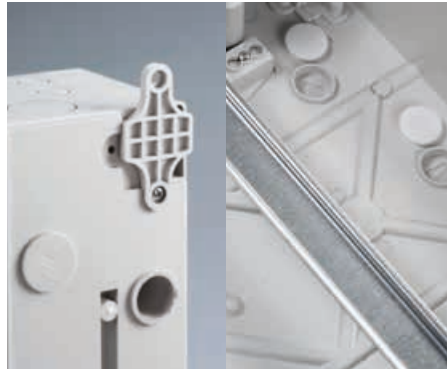

Interior slots allow the consumer unit to be fixed to the wall in points which are not visible from the outside, thus contributing to an aesthetically clean installation. Special snap-in closure plugs guarantee protection class II (double insulated).



The possibility to add an additional module by removing two pre-trimmed elements is an extremely useful solution which allows additions to be managed easily and tidily when unforeseen installation requirements are called for.



To speed up cabling and make it neater, various snap-on terminal blocks can be installed (optional and in two different colours), both in the upper and the lower part of the consumer unit. The terminals come in two versions: screw and quick-coupling, for easy and effective cabling with any type of conductor.



The standard door with ergonomic handle and snap-on closure can be supplied with a lock and key on request, ensuring only authorised persons have access and avoiding tampering or incorrect operations.

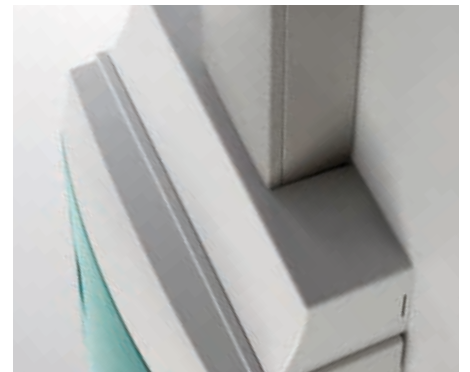

The new polycarbonate accessory for trunking entry can be positioned at the top or bottom of the consumer unit, connecting and protecting the conductor bundles. A series of internal knockouts allows it to house any type of trunking.

# A point of view. Never seen before

## The technical characteristics and installation possibilities

Practical rear brackets provide practical and stable wall fastening

Every front panel is supplied with captive screws, giving practical and safety advantages



The side knockouts offer additional possibilities for the cables' path

The dual gasket on the front panel module ensures an improved seal

All accessories and the slightest details have been designed and developed in order for the consumer unit to maintain double insulation properties at all times



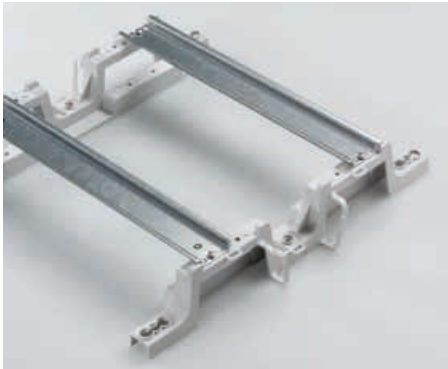

The extractable frame simplifies and speeds up bench cabling operations. The slotted holes in the frame allow it to be quickly fixed inside the enclosure.

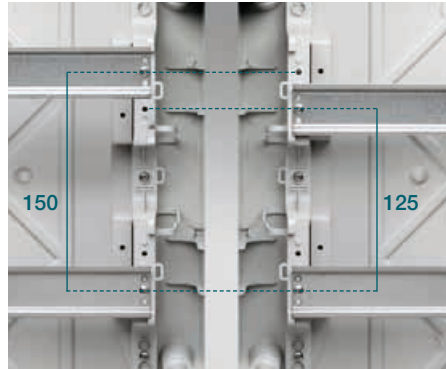

In order to create space at the top or bottom of the consumer unit, the centre distance of the DIN rails can be modified from the standard distance of 150 mm to 125 mm. The closure panels, which are completely reversible, can be unhooked, reversed and reinstalled with a simple click.



Spaces have been created inside the consumer units to make cabling even easier, with cable clips and holes for fastening the conductors to the frame with simple cable-ties.



If the consumer unit must be made completely inaccessible, it is possible to use accessories to seal the front panel.



The consumer units can be installed side by side, with cable gland accessories protecting the conductors' path between adjacent units.



The accessories include blind panels and base plates allowing installation of other types of devices aside from modular DIN rail products such as contactors, manual motor starters or devices on the front of the panel.

## A point of contact with the world of ABB Perfect coordination with all products

The project was inspired by the objective of allowing a wide range of products and solutions with different functions and dimensions to be installed in a single IP65 consumer unit, thus meeting the widest range of needs. MCBs, MCCBs and devices installed in the front of the panel in an integrated, rational and functionally appropriate position.



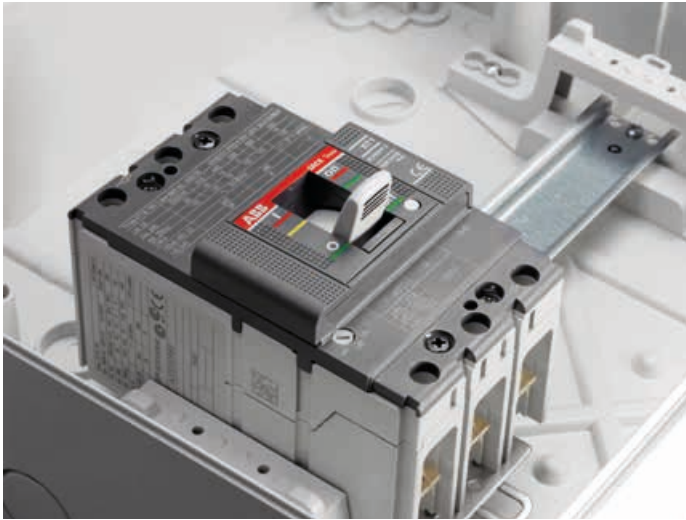

The frame allows for two different DIN rail positions. This allows products with different depths to be installed, for example MCCBs which, thanks to this solution, are perfectly aligned with other devices in the panel.

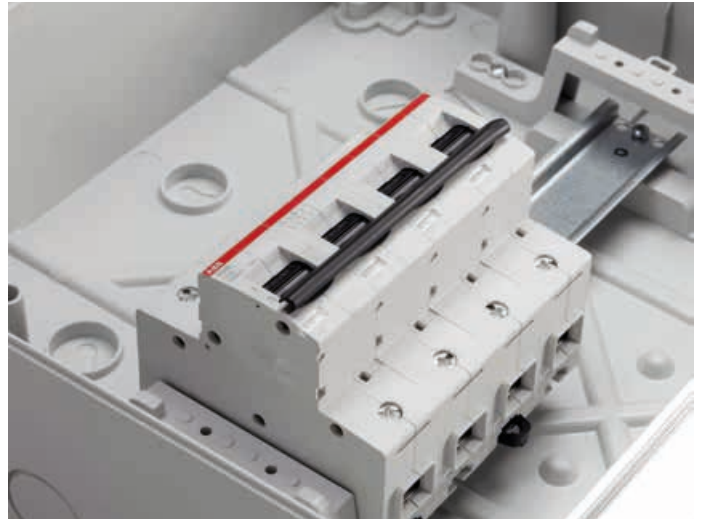

Among these components with greater depth dimensions which can benefit from this flexibility of the frame, we must remember high-performance MCBs with greater than standard depth.

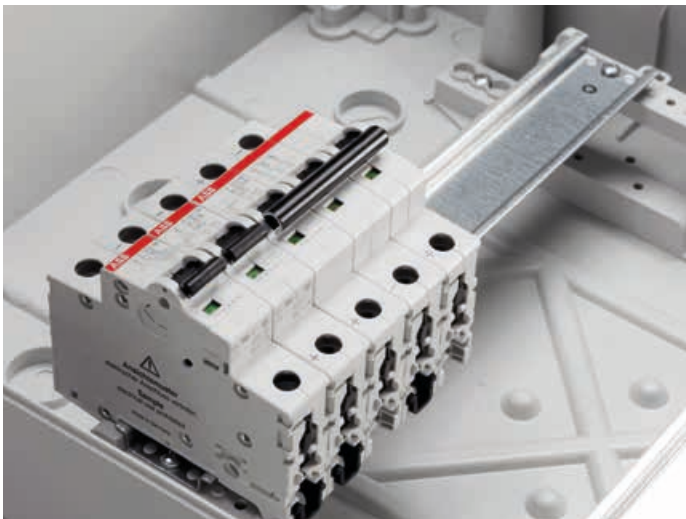

The first depth level allows standard products to be housed; these include most modular products currently available on the market.



Among the accessories, the availability of blank panels and base plates allows non-modular equipment to be installed on the front of the consumer unit, such as control buttons and indicator lights.

## A point of departure for made-to-measure solutions The flexibility of a range designed for every application

The simplicity of the consumer units makes adapting them to various system requirements easy.

Optional terminal blocks which can be installed in the top or bottom of the consumer unit allow the cabling to be performed in a tidy manner and their different colours facilitate recognition of any separate circuits.

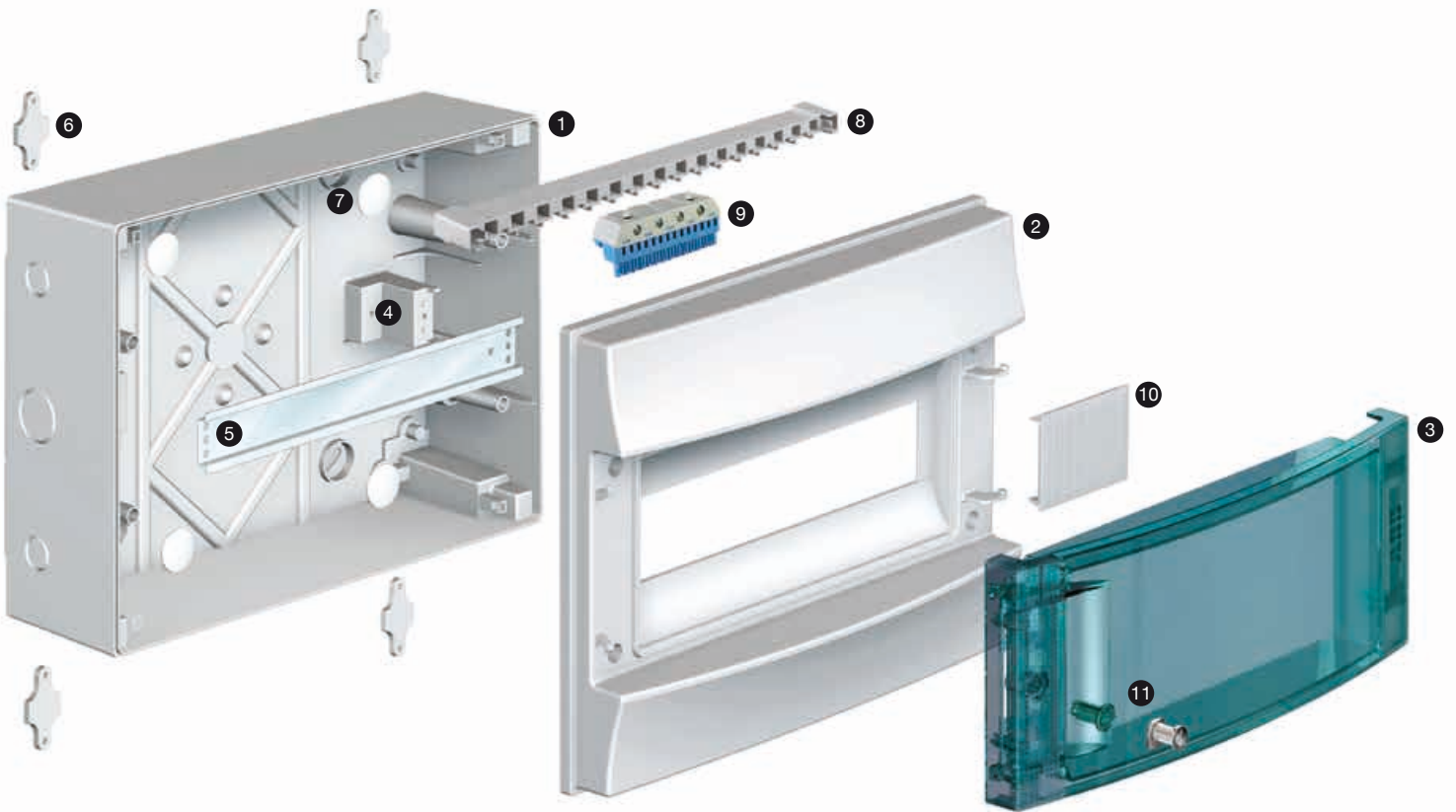

- |                               |   |
|-------------------------------|---|
| 1. Box for wall mounting      | 7. Plugs, protection class II                             |
| 2. Reversible front panel     | 8. Jumper for terminals                                   |
| 3. Transparent door           | 9. Quick-coupling terminals                               |
| 4. Fixed support for DIN rail | 10. Module cover  |
| 5. DIN rail                   | 11. Finish or closure elements<br>(lock and key optional) |
| 6. Wall fastening brackets    |   |

The perfectly symmetrical design of the front panel makes the choice of opening direction for the door simple – this can be changed just by rotating the whole structure, without having to perform risky separation of parts. The extractable doors also facilitate access to the various components installed in the consumer unit.

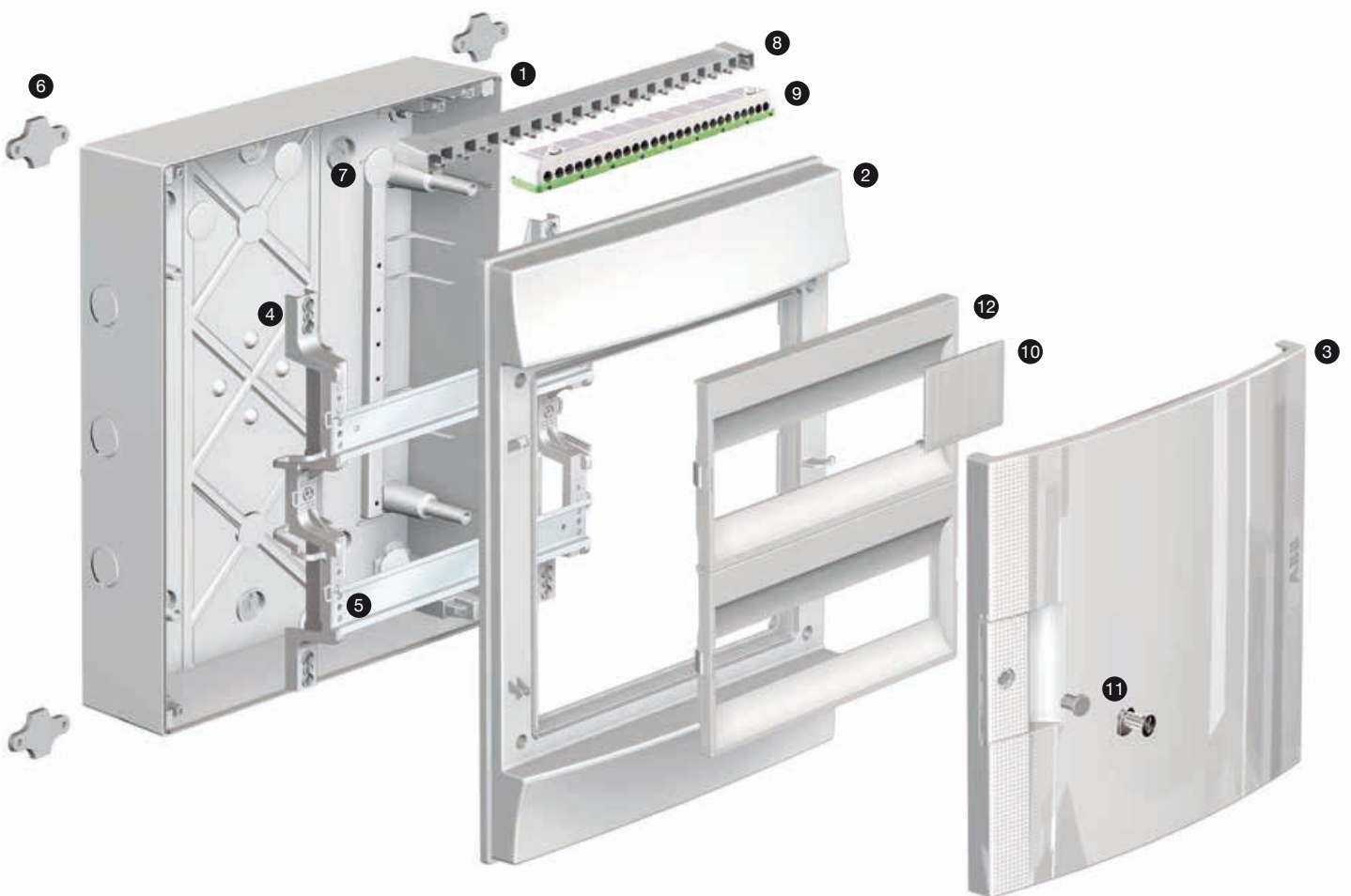

- |                               |   |
|-------------------------------|---|
| 1. Box for wall mounting      | 8. Jumper for terminals                                   |
| 2. Reversible front panel     | 9. Quick-coupling terminals                               |
| 3. RAL 7035 opaque door       | 10. Module cover  |
| 4. Fixed support for DIN rail | 11. Finish or closure elements<br>(lock and key optional) |
| 5. DIN rail                   | 12. Reversible panels                                     |
| 6. Wall fastening brackets    |   |
| 7. Plugs, protection class II |   |

# Order codes



801001F0901



801002F0901

4 modules



801003F0901



801004F0901

8 modules



801005F0901



801006F0901

12 modules



801007F0901



801008F0901

18 modules

| Description                    | GWT | N. modules | Dimensions WxHxD | ABB code   | Order code | Pack./ N. pieces |
|--------------------------------|-----|------------|------------------|------------|------------|------------------|
|                                |     | [18 mm]    | [mm]             |            |            |                  |
| <b>1 Row</b>                   |     |            |                  |            |            |                  |
| MISTRAL65 opaque door 4M       | 650 | 4          | 152x202x117      | 1SL1100A00 | 1SL1100A00 | 1/24             |
| MISTRAL65 transparent door 4M  | 650 | 4          | 152x202x117      | 1SL1200A00 | 1SL1200A00 | 1/24             |
| MISTRAL65 opaque door 8M       | 650 | 8          | 232x250x154      | 1SL1101A00 | 1SL1101A00 | 1/11             |
| MISTRAL65 transparent door 8M  | 650 | 8          | 232x250x154      | 1SL1201A00 | 1SL1201A00 | 1/11             |
| MISTRAL65 opaque door 12M      | 650 | 12         | 320x250x155      | 1SL1102A00 | 1SL1102A00 | 1/7              |
| MISTRAL65 transparent door 12M | 650 | 12         | 320x250x155      | 1SL1202A00 | 1SL1202A00 | 1/7              |
| MISTRAL65 opaque door 18M      | 650 | 18         | 430x250x155      | 1SL1103A00 | 1SL1103A00 | 1/4              |
| MISTRAL65 transparent door 18M | 650 | 18         | 430x250x155      | 1SL1203A00 | 1SL1203A00 | 1/4              |



801009F0901



801010F0901

24 modules



801011F0901



801012F0901

36 modules

| Description                       | GWT | N. modules | Dimensions WxHxD | ABB code   | Order code | Pack./ N. pieces |
|-----------------------------------|-----|------------|------------------|------------|------------|------------------|
|                                   |     | [18 mm]    | [mm]             |            |            |                  |
| <b>2 Rows</b>                     |     |            |                  |            |            |                  |
| MISTRAL65 opaque door 24M         | 650 | 24         | 320x435x155      | 1SL1104A00 | 1SL1104A00 | 1/4              |
| MISTRAL65 transparent door 24M    | 650 | 24         | 320x435x155      | 1SL1204A00 | 1SL1204A00 | 1/4              |
| MISTRAL65 opaque door 36M 2F      | 650 | 36         | 430x435x155      | 1SL1105A00 | 1SL1105A00 | 1/2              |
| MISTRAL65 transparent door 36M 2F | 650 | 36         | 430x435x155      | 1SL1205A00 | 1SL1205A00 | 1/2              |



801013FC901

801014FC901

36 modules

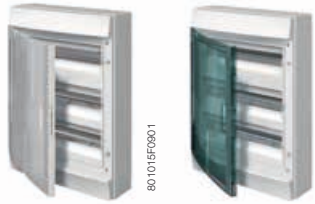

801015FC901

801016FC901

54 modules

| Description                       | GWT | N. modules<br>[18 mm] | Dimensions<br>WxHxD<br>[mm] | ABB code   | Order code | Pack./<br>N. pieces |
|-----------------------------------|-----|-----------------------|-----------------------------|------------|------------|---------------------|
| <b>3 Rows</b>                     |     |                       |                             |            |            |                     |
| MISTRAL65 opaque door 36M 3F      | 650 | 36                    | 320x600x155                 | 1SL1106A00 | 1SL1106A00 | 1/3                 |
| MISTRAL65 transparent door 36M 3F | 650 | 36                    | 320x600x155                 | 1SL1206A00 | 1SL1206A00 | 1/3                 |

|                                |     |    |             |            |            |     |
|--------------------------------|-----|----|-------------|------------|------------|-----|
| MISTRAL65 opaque door 54M      | 650 | 54 | 430x600x155 | 1SL1108A00 | 1SL1108A00 | 1/1 |
| MISTRAL65 transparent door 54M | 650 | 54 | 430x600x155 | 1SL1208A00 | 1SL1208A00 | 1/1 |

| Description                    | GWT | N. modules<br>[18 mm] | Dimensions<br>WxHxD<br>[mm] | ABB code   | Order code | Pack./<br>N. pieces |
|--------------------------------|-----|-----------------------|-----------------------------|------------|------------|---------------------|
| <b>4 Rows</b>                  |     |                       |                             |            |            |                     |
| MISTRAL65 opaque door 48M      | 650 | 48                    | 320x735x155                 | 1SL1107A00 | 1SL1107A00 | 1/1                 |
| MISTRAL65 transparent door 48M | 650 | 48                    | 320x735x155                 | 1SL1207A00 | 1SL1207A00 | 1/1                 |



801017FC901

801018FC901

48 modules



801019FC901

801020FC901

72 modules

|                                |     |    |             |            |            |     |
|--------------------------------|-----|----|-------------|------------|------------|-----|
| MISTRAL65 opaque door 72M      | 650 | 72 | 430x735x155 | 1SL1109A00 | 1SL1109A00 | 1/1 |
| MISTRAL65 transparent door 72M | 650 | 72 | 430x735x155 | 1SL1209A00 | 1SL1209A00 | 1/1 |

# Order codes



801002F0901

4 modules



801004F0901

8 modules



801006F0901

12 modules



801008F0901

18 modules

| Description                       | GWT | N. modules<br>[18 mm] | Dimensions<br>WxHxD<br>[mm] | ABB code        | Order code | Pack./<br>N. pieces |
|-----------------------------------|-----|-----------------------|-----------------------------|-----------------|------------|---------------------|
| <b>1 Row</b>                      |     |                       |                             |                 |            |                     |
| MISTRAL65 750 transparent door 4M | 750 | 4                     | 152x202x117                 | 1SLM006500A1210 | 1SL1210A00 | 1/24                |

|                                   |     |   |             |                 |            |      |
|-----------------------------------|-----|---|-------------|-----------------|------------|------|
| MISTRAL65 750 transparent door 8M | 750 | 8 | 232x250x154 | 1SLM006500A1211 | 1SL1211A00 | 1/11 |
|-----------------------------------|-----|---|-------------|-----------------|------------|------|

|                                    |     |    |             |                 |            |     |
|------------------------------------|-----|----|-------------|-----------------|------------|-----|
| MISTRAL65 750 transparent door 12M | 750 | 12 | 320x250x155 | 1SLM006500A1212 | 1SL1212A00 | 1/7 |
|------------------------------------|-----|----|-------------|-----------------|------------|-----|

|                                    |     |    |             |                 |            |     |
|------------------------------------|-----|----|-------------|-----------------|------------|-----|
| MISTRAL65 750 transparent door 18M | 750 | 18 | 430x250x155 | 1SLM006500A1213 | 1SL1213A00 | 1/4 |
|------------------------------------|-----|----|-------------|-----------------|------------|-----|

| Description                        | GWT | N. modules<br>[18 mm] | Dimensions<br>WxHxD<br>[mm] | ABB code        | Order code | Pack./<br>N. pieces |
|------------------------------------|-----|-----------------------|-----------------------------|-----------------|------------|---------------------|
| <b>2 Rows</b>                      |     |                       |                             |                 |            |                     |
| MISTRAL65 750 transparent door 24M | 750 | 24                    | 320x435x155                 | 1SLM006500A1214 | 1SL1214A00 | 1/4                 |



801010F0901

24 modules



801012F0901

36 modules

|                                       |     |    |             |                 |            |     |
|---------------------------------------|-----|----|-------------|-----------------|------------|-----|
| MISTRAL65 750 transparent door 36M 2F | 750 | 36 | 430x435x155 | 1SLM006500A1215 | 1SL1215A00 | 1/2 |
|---------------------------------------|-----|----|-------------|-----------------|------------|-----|





801014F0901

36 modules



801016F0901

54 modules



801018F0901

48 modules



801020F0901

72 modules

| Description                           | GWT | N. modules | Dimensions WxHxD | ABB code        | Order code | Pack./ N. pieces |
|---------------------------------------|-----|------------|------------------|-----------------|------------|------------------|
|                                       |     | [18 mm]    | [mm]             |                 |            |                  |
| <b>3 Rows</b>                         |     |            |                  |                 |            |                  |
| MISTRAL65 750 transparent door 36M 3F | 750 | 36         | 320x600x155      | 1SLM006500A1216 | 1SL1216A00 | 1/3              |

|                                    |     |    |             |                 |            |     |
|------------------------------------|-----|----|-------------|-----------------|------------|-----|
| MISTRAL65 750 transparent door 54M | 750 | 54 | 430x600x155 | 1SLM006500A1218 | 1SL1218A00 | 1/1 |
|------------------------------------|-----|----|-------------|-----------------|------------|-----|

| Description                        | GWT | N. modules | Dimensions WxHxD | ABB code        | Order code | Pack./ N. pieces |
|------------------------------------|-----|------------|------------------|-----------------|------------|------------------|
|                                    |     | [18 mm]    | [mm]             |                 |            |                  |
| <b>4 Rows</b>                      |     |            |                  |                 |            |                  |
| MISTRAL65 750 transparent door 48M | 750 | 48         | 320x735x155      | 1SLM006500A1217 | 1SL1217A00 | 1/1              |

|                                    |     |    |             |                 |            |     |
|------------------------------------|-----|----|-------------|-----------------|------------|-----|
| MISTRAL65 750 transparent door 72M | 750 | 72 | 430x735x155 | 1SLM006500A1219 | 1SL1219A00 | 1/1 |
|------------------------------------|-----|----|-------------|-----------------|------------|-----|

# Order codes



| Description                        | GWT | N. modules<br>[18 mm] | Dimensions<br>WxHxD<br>[mm] | ABB code        | Order code      | Pack./<br>N. pieces |
|------------------------------------|-----|-----------------------|-----------------------------|-----------------|-----------------|---------------------|
| MISTRAL65 transparent door 8M 12SM | 650 | 8                     | 232x250x154                 | 1SLM006501A1201 | 1SLM006501A1201 | 1/11                |



|                                     |     |    |             |                 |                 |     |
|-------------------------------------|-----|----|-------------|-----------------|-----------------|-----|
| MISTRAL65 transparent door 12M 22SM | 650 | 12 | 320x250x155 | 1SLM006501A1202 | 1SLM006501A1202 | 1/7 |
|-------------------------------------|-----|----|-------------|-----------------|-----------------|-----|



|                                     |     |    |             |                 |                 |     |
|-------------------------------------|-----|----|-------------|-----------------|-----------------|-----|
| MISTRAL65 transparent door 18M 12SM | 650 | 18 | 430x250x155 | 1SLM006501A1203 | 1SLM006501A1203 | 1/4 |
|-------------------------------------|-----|----|-------------|-----------------|-----------------|-----|



|                                     |     |    |             |                 |                 |     |
|-------------------------------------|-----|----|-------------|-----------------|-----------------|-----|
| MISTRAL65 transparent door 18M 32SM | 650 | 18 | 430x250x155 | 1SLM006502A1203 | 1SLM006502A1203 | 1/4 |
|-------------------------------------|-----|----|-------------|-----------------|-----------------|-----|



|                                     |     |    |             |                 |                 |     |
|-------------------------------------|-----|----|-------------|-----------------|-----------------|-----|
| MISTRAL65 transparent door 24M 22SM | 650 | 24 | 320x435x155 | 1SLM006501A1204 | 1SLM006501A1204 | 1/4 |
|-------------------------------------|-----|----|-------------|-----------------|-----------------|-----|



|                                     |     |    |             |                 |                 |     |
|-------------------------------------|-----|----|-------------|-----------------|-----------------|-----|
| MISTRAL65 transparent door 24M 42SM | 650 | 24 | 320x435x155 | 1SLM006502A1204 | 1SLM006502A1204 | 1/4 |
|-------------------------------------|-----|----|-------------|-----------------|-----------------|-----|



801012F0601

36 modules

| Description                            | GWT | N. modules<br>[18 mm] | Dimensions<br>WxHxD<br>[mm] | ABB code        | Order code      | Pack./<br>N. pieces |
|--|-----|-----------------------|-----------------------------|-----------------|-----------------|---------------------|
| MISTRAL65 transparent door 36M 2F 52SM | 650 | 36                    | 430x435x155                 | 1SLM006501A1205 | 1SLM006501A1205 | 1/2                 |

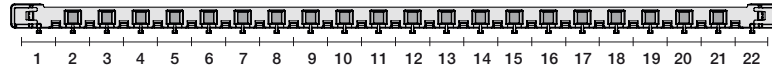

1SPE007715F0753



1SPE007715F0735



1SPE007715F0745



801014F0901

36 modules

|  |     |    |             |                 |                 |     |
|--|-----|----|-------------|-----------------|-----------------|-----|
| MISTRAL65 transparent door 36M 3F 42SM | 650 | 36 | 320x600x155 | 1SLM006501A1206 | 1SLM006501A1206 | 1/3 |
|--|-----|----|-------------|-----------------|-----------------|-----|



1SPE007715F0752



1SPE007715F0752



1SPE007715F0734



1SPE007715F0744



801018F0901

48 modules

|                                     |     |    |             |                 |                 |     |
|-------------------------------------|-----|----|-------------|-----------------|-----------------|-----|
| MISTRAL65 transparent door 48M 52SM | 650 | 48 | 320x735x155 | 1SLM006501A1207 | 1SLM006501A1207 | 1/1 |
|-------------------------------------|-----|----|-------------|-----------------|-----------------|-----|



1SPE007715F0752



1SPE007715F0752

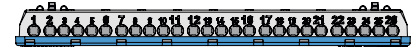

1SPE007715F0735



1SPE007715F0745



801018F0901

54 modules

|                                     |     |    |             |                 |                 |     |
|-------------------------------------|-----|----|-------------|-----------------|-----------------|-----|
| MISTRAL65 transparent door 54M 52SM | 650 | 54 | 430x600x155 | 1SLM006501A1208 | 1SLM006501A1208 | 1/1 |
|-------------------------------------|-----|----|-------------|-----------------|-----------------|-----|



1SPE007715F0753



1SPE007715F0735



1SPE007715F0745



801020F0901

72 modules

|                                     |     |    |             |                 |                 |     |
|-------------------------------------|-----|----|-------------|-----------------|-----------------|-----|
| MISTRAL65 transparent door 72M 52SM | 650 | 72 | 430x735x155 | 1SLM006501A1209 | 1SLM006501A1209 | 1/1 |
|-------------------------------------|-----|----|-------------|-----------------|-----------------|-----|



1SPE007715F0753



1SPE007715F0735



1SPE007715F0745

# Order codes



801021F0901

Opaque door



801022FC601

Transparent door



801023FC601

Base plates



801024FC601

Blind panel

| Description                          | ABB code        | Order code | Pack./<br>N. pieces |
|--------------------------------------|-----------------|------------|---------------------|
| <b>Opaque door</b>                   |                 |            |                     |
| Opaque door 4M MISTRAL65             | 1SLM006500A1900 | 1SL1900A00 | 1/15                |
| Opaque door 8M MISTRAL65             | 1SLM006500A1902 | 1SL1902A00 | 1/20                |
| Opaque door 12M MISTRAL65            | 1SLM006500A1904 | 1SL1904A00 | 1/10                |
| Opaque door 18M MISTRAL65            | 1SLM006500A1906 | 1SL1906A00 | 1/20                |
| Opaque door 24M / 48M MISTRAL65      | 1SLM006500A1908 | 1SL1908A00 | 1/6                 |
| Opaque door 36M MISTRAL65            | 1SLM006500A1910 | 1SL1910A00 | 1/10                |
| Opaque door 36M / 72M MISTRAL65      | 1SLM006500A1912 | 1SL1912A00 | 1/14                |
| Opaque door 54M MISTRAL65            | 1SLM006500A1914 | 1SL1914A00 | 1/8                 |
| <b>Transparent door</b>              |                 |            |                     |
| Transparent door 4M MISTRAL65        | 1SLM006500A1901 | 1SL1901A00 | 1/15                |
| Transparent door 8M MISTRAL65        | 1SLM006500A1903 | 1SL1903A00 | 1/20                |
| Transparent door 12M MISTRAL65       | 1SLM006500A1905 | 1SL1905A00 | 1/10                |
| Transparent door 18M MISTRAL65       | 1SLM006500A1907 | 1SL1907A00 | 1/20                |
| Transparent door 24M / 48M MISTRAL65 | 1SLM006500A1909 | 1SL1909A00 | 1/6                 |
| Transparent door 36M MISTRAL65       | 1SLM006500A1911 | 1SL1911A00 | 1/10                |
| Transparent door 36M / 72M MISTRAL65 | 1SLM006500A1913 | 1SL1913A00 | 1/14                |
| Transparent door 54M MISTRAL65       | 1SLM006500A1915 | 1SL1915A00 | 1/8                 |
| <b>Base plates</b>                   |                 |            |                     |
| Metal base plate 12M MISTRAL65       | 1SLM006500A1920 | 1SL1920A00 | 1/12                |
| Metal base plate 2x12M MISTRAL65     | 1SLM006500A1921 | 1SL1921A00 | 1/4                 |
| Metal base plate 18M MISTRAL65       | 1SLM006500A1922 | 1SL1922A00 | 1/8                 |
| Metal base plate 2x18M MISTRAL65     | 1SLM006500A1923 | 1SL1923A00 | 1/4                 |
| <b>Blind panel</b>                   |                 |            |                     |
| Central blind panel 12M MISTRAL65 *  | 1SLM006500A1945 | 1SL1945A00 | 1/15                |
| Blind panel 12M MISTRAL65            | 1SLM006500A1946 | 1SL1946A00 | 1/20                |
| Central blind panel 18M MISTRAL65 ** | 1SLM006500A1947 | 1SL1947A00 | 1/30                |
| Blind panel 18M MISTRAL65            | 1SLM006500A1948 | 1SL1948A00 | 1/30                |

\* MISTRAL65 panels 3 lines - 36 modules

\*\* MISTRAL65 panels 3 lines - 54 modules



801025FC901

Wall fixing bracket



801026FC901

Module cover



801027FC901

Lock



801028FC901

Cable gland



801029FC901

Adapter for trunking



801030FC901

Junction unit



801031FC901

Terminal carrier

| Description                            | ABB code        | Order code      | Pack./<br>N. pieces |
|--|-----------------|-----------------|---------------------|
| <b>Other accessories</b>               |                 |                 |                     |
| Wall fixing brackets (4 pcs) MISTRAL65 | 1SLM006500A1927 | 1SL1927A00      | 1/30                |
| Module cover 12M MISTRAL65             | 1SLM006500A1929 | 1SL1929A00      | 5/180               |
| Sealing kit MISTRAL65                  | 1SLM006500A1950 | 1SL1950A00      | 1/50                |
| Lock with key MISTRAL65                | 1SLM006500A1931 | 1SL1931A00      | 1/10                |
| <b>Cable glands</b>                    |                 |                 |                     |
| Cable gland Ø 16                       | 1SLM006500A1935 | 1SL1935A00      | 10/100              |
| Cable gland Ø 20                       | 1SLM006500A1936 | 1SL1936A00      | 10/100              |
| Cable gland Ø 25                       | 1SLM006500A1937 | 1SL1937A00      | 10/100              |
| Cable gland Ø 32                       | 1SLM006500A1938 | 1SL1938A00      | 5/50                |
| <b>Adapter</b>                         |                 |                 |                     |
| Adapter for trunking MISTRAL65         | 1SLM006500A1942 | 1SL1942A00      | 1/10                |
| <b>Junction unit</b>                   |                 |                 |                     |
| Junction unit Ø 28,5 MISTRAL65         | 1SLM006500A1949 | 1SL1949A00      | 10/400              |
| <b>Terminal carrier</b>                |                 |                 |                     |
| Terminal carrier 8M MISTRAL65          | 1SPE007715F0751 | 1SPE007715F0751 | 5/280               |
| Terminal carrier 12M MISTRAL65         | 1SPE007715F0752 | 1SPE007715F0752 | 5/225               |
| Terminal carrier 18M MISTRAL65         | 1SPE007715F0753 | 1SPE007715F0753 | 5/150               |

# Order codes

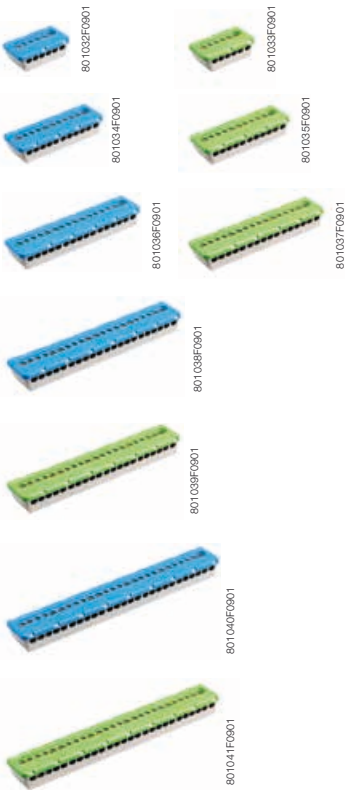

**Terminal block**

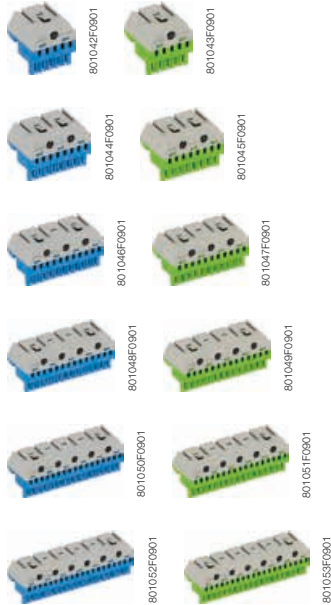

**Terminal block screwless**

| Description  | Maximum current | ABB code        | Order code      | Pack./ N. pieces |
|--|-----------------|-----------------|-----------------|------------------|
| <b>Terminal block</b>  |                 |                 |                 |                  |
| Terminal block N 3x16mm <sup>2</sup> +3x6mm <sup>2</sup>                 | 100 A           | 1SPE007715F0731 | 1SPE007715F0731 | 5/270            |
| Terminal block N 5x16mm <sup>2</sup> +6x6mm <sup>2</sup>                 | 100 A           | 1SPE007715F0732 | 1SPE007715F0732 | 5/150            |
| Terminal block N 7x16mm <sup>2</sup> +9x6mm <sup>2</sup>                 | 100 A           | 1SPE007715F0733 | 1SPE007715F0733 | 5/120            |
| Terminal block N 9x16mm <sup>2</sup> +12x6mm <sup>2</sup>                | 100 A           | 1SPE007715F0734 | 1SPE007715F0734 | 5/90             |
| Terminal block N 11x16mm <sup>2</sup> +15x6mm <sup>2</sup>               | 100 A           | 1SPE007715F0735 | 1SPE007715F0735 | 5/90             |
| Terminal block PE 3x16mm <sup>2</sup> +3x6mm <sup>2</sup>                | 100 A           | 1SPE007715F0741 | 1SPE007715F0741 | 5/270            |
| Terminal block PE 5x16mm <sup>2</sup> +6x6mm <sup>2</sup>                | 100 A           | 1SPE007715F0742 | 1SPE007715F0742 | 5/150            |
| Terminal block PE 7x16mm <sup>2</sup> +9x6mm <sup>2</sup>                | 100 A           | 1SPE007715F0743 | 1SPE007715F0743 | 5/120            |
| Terminal block PE 9x16mm <sup>2</sup> +12x6mm <sup>2</sup>               | 100 A           | 1SPE007715F0744 | 1SPE007715F0744 | 5/90             |
| Terminal block PE 11x16mm <sup>2</sup> +15x6mm <sup>2</sup>              | 100 A           | 1SPE007715F0745 | 1SPE007715F0745 | 5/90             |
| <b>Terminal block screwless</b>  |                 |                 |                 |                  |
| Terminal block screwless N 5x1,5-4mm <sup>2</sup>                        | 63 A            | 1SPE007715F9701 | 1SPE007715F9701 | 5/280            |
| Terminal block screwless N 5x1,5-4mm <sup>2</sup> +1x25mm <sup>2</sup>   | 63 A            | 1SPE007715F9702 | 1SPE007715F9702 | 5/180            |
| Terminal block screwless N 8x1,5-4mm <sup>2</sup> +2x25mm <sup>2</sup>   | 63 A            | 1SPE007715F9703 | 1SPE007715F9703 | 5/150            |
| Terminal block screwless N 11x1,5-4mm <sup>2</sup> +3x25mm <sup>2</sup>  | 63 A            | 1SPE007715F9704 | 1SPE007715F9704 | 5/120            |
| Terminal block screwless N 14x1,5-4mm <sup>2</sup> +4x25mm <sup>2</sup>  | 63 A            | 1SPE007715F9705 | 1SPE007715F9705 | 5/90             |
| Terminal block screwless N 17x1,5-4mm <sup>2</sup> +5x25mm <sup>2</sup>  | 63 A            | 1SPE007715F9706 | 1SPE007715F9706 | 5/70             |
| Terminal block screwless N 20x1,5-4mm <sup>2</sup> +6x25mm <sup>2</sup>  | 63 A            | 1SPE007715F9707 | 1SPE007715F9707 | 5/60             |
| Terminal block screwless PE 5x1,5-4mm <sup>2</sup> +1x25mm <sup>2</sup>  | 63 A            | 1SPE007715F9712 | 1SPE007715F9712 | 5/180            |
| Terminal block screwless PE 8x1,5-4mm <sup>2</sup> +2x25mm <sup>2</sup>  | 63 A            | 1SPE007715F9713 | 1SPE007715F9713 | 5/150            |
| Terminal block screwless PE 11x1,5-4mm <sup>2</sup> +3x25mm <sup>2</sup> | 63 A            | 1SPE007715F9714 | 1SPE007715F9714 | 5/120            |
| Terminal block screwless PE 14x1,5-4mm <sup>2</sup> +4x25mm <sup>2</sup> | 63 A            | 1SPE007715F9715 | 1SPE007715F9715 | 5/90             |
| Terminal block screwless PE 17x1,5-4mm <sup>2</sup> +5x25mm <sup>2</sup> | 63 A            | 1SPE007715F9716 | 1SPE007715F9716 | 5/70             |
| Terminal block screwless PE 20x1,5-4mm <sup>2</sup> +6x25mm <sup>2</sup> | 63 A            | 1SPE007715F9717 | 1SPE007715F9717 | 5/60             |

# Terminal blocks

## Terminal carriers

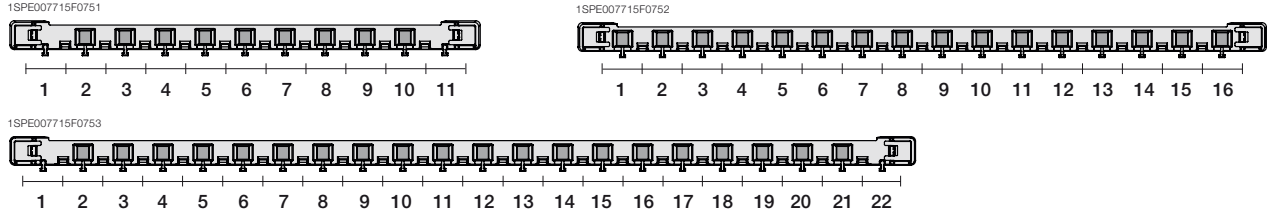

## Terminal block

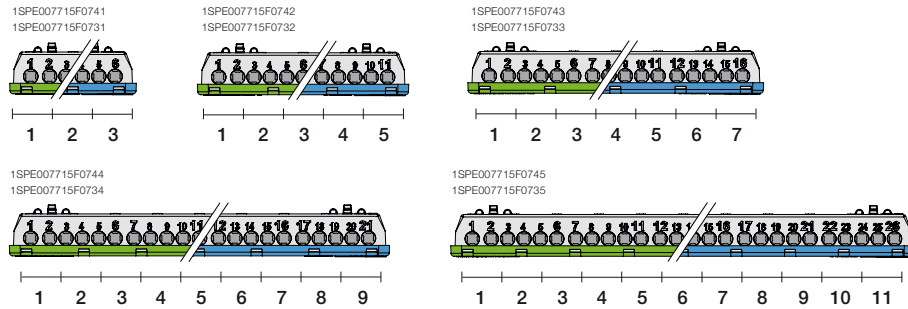

## Terminal block screwless

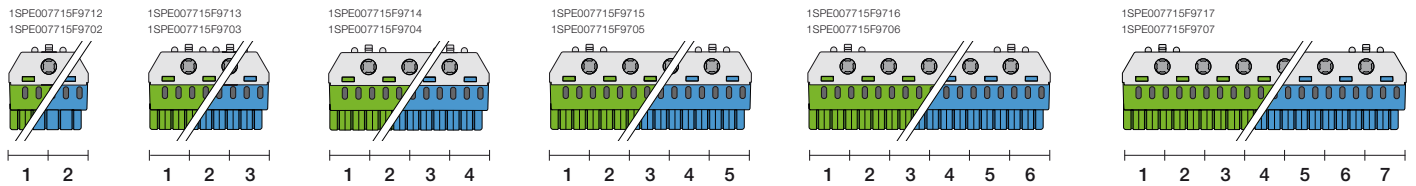

## Assembly examples

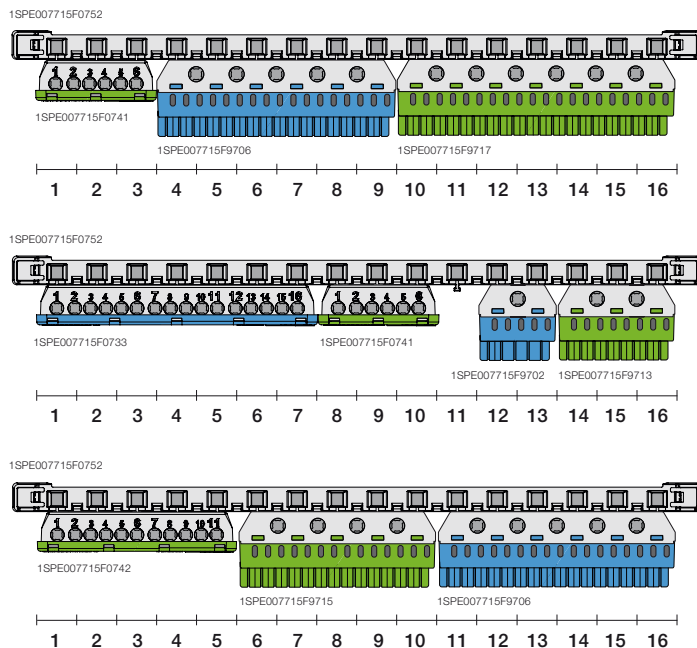





# Technical details





| Codes                                     | 1SL1100A00<br>1SL1200A00 | 1SL1101A00<br>1SL1201A00<br>1SLM006501A1201 | 1SL1102A00<br>1SL1202A00<br>1SLM006501A1202 | 1SL1103A00<br>1SL1203A00<br>1SLM006501A1203<br>1SLM006502A1203 | 1SL1104A00<br>1SL1204A00<br>1SLM006501A1204<br>1SLM006502A1204 |
|---|--------------------------|---|---|--|--|
| Number of modules                         | 4                        | 8   | 12  | 18   | 24   |
| Dimensions (WxHxD) in mm                  | 152 x 202 x 117          | 232 x 250 x 154                             | 320 x 250 x 155                             | 430 x 250 x 155  | 320 x 435 x 155  |
| Colour                                    | RAL 7035 grey            | RAL 7035 grey                               | RAL 7035 grey                               | RAL 7035 grey  | RAL 7035 grey  |
| Door type                                 | Opaque / Transparent     | Opaque / Transparent                        | Opaque / Transparent                        | Opaque / Transparent   | Opaque / Transparent   |
| Protection class                          | II ☐                     | II ☐  | II ☐  | II ☐   | II ☐   |
| Fire resistance                           | GWT 650°C                | GWT 650°C                                   | GWT 650°C                                   | GWT 650°C  | GWT 650°C  |
| Material                                  | Thermoplastic            | Thermoplastic                               | Thermoplastic                               | Thermoplastic  | Thermoplastic  |
| Resistance to mechanical impacts          | IK09                     | IK09  | IK09  | IK09   | IK09   |
| Knockout resistance to mechanical impacts | IK08                     | IK08  | IK08  | IK08   | IK08   |
| Installation temperature                  | -25°C / +60°C            | -25°C / +60°C                               | -25°C / +60°C                               | -25°C / +60°C  | -25°C / +60°C  |
| Resistance to heat                        | BPT 70°C                 | BPT 70°C                                    | BPT 70°C                                    | BPT 70°C   | BPT 70°C   |
| IP rating                                 | IP65                     | IP65  | IP65  | IP65   | IP65   |
| Max. dissipation power                    | 12 W                     | 20 W  | 27 W  | 32 W   | 34 W   |
| Maximum current                           | 63A                      | 63A   | 63A   | 125A   | 125A   |
| Extractable frame                         | no                       | no  | no  | no   | yes  |
| Additional module                         | no                       | no  | yes   | yes  | yes  |
| Installation of MCCBs                     | no                       | yes   | yes   | yes  | yes  |
| DIN rail centre distance                  | -                        | -   | -   | -  | 150 - 125 (mm)   |
| Halogen free                              | yes                      | yes   | yes   | yes  | yes  |
| Cable entry finish                        | Smooth                   | Smooth                                      | Smooth                                      | Smooth   | Smooth   |

| Codes                                     | 1SL1105A00<br>1SL1205A00<br>1SLM006501A1205 | 1SL1106A00<br>1SL1206A00<br>1SLM006501A1206 | 1SL1107A00<br>1SL1207A00<br>1SLM006501A1207 | 1SL1108A00<br>1SL1208A00<br>1SLM006501A1208 | 1SL1109A00<br>1SL1209A00<br>1SLM006501A1209 |
|---|---|---|---|---|---|
| Number of modules                         | 36  | 36  | 48  | 54  | 72  |
| Dimensions (WxHxD) in mm                  | 430 x 435 x 155                             | 320 x 435 x 155                             | 320 x 735 x 155                             | 430 x 600 x 155                             | 430 x 735 x 155                             |
| Colour                                    | RAL 7035 grey                               | RAL 7035 grey                               | RAL 7035 grey                               | RAL 7035 grey                               | RAL 7035 grey                               |
| Door type                                 | Opaque / Transparent                        | Opaque / Transparent                        | Opaque / Transparent                        | Opaque / Transparent                        | Opaque / Transparent                        |
| Protection class                          | II ☐  | II ☐  | II ☐  | II ☐  | II ☐  |
| Fire resistance                           | GWT 650°C                                   | GWT 650°C                                   | GWT 650°C                                   | GWT 650°C                                   | GWT 650°C                                   |
| Material                                  | Thermoplastic                               | Thermoplastic                               | Thermoplastic                               | Thermoplastic                               | Thermoplastic                               |
| Resistance to mechanical impacts          | IK09  | IK09  | IK09  | IK09  | IK09  |
| Knockout resistance to mechanical impacts | IK08  | IK08  | IK08  | IK08  | IK08  |
| Installation temperature                  | -25°C / +60°C                               | -25°C / +60°C                               | -25°C / +60°C                               | -25°C / +60°C                               | -25°C / +60°C                               |
| Resistance to heat                        | BPT 70°C                                    | BPT 70°C                                    | BPT 70°C                                    | BPT 70°C                                    | BPT 70°C                                    |
| IP rating                                 | IP65  | IP65  | IP65  | IP65  | IP65  |
| Max. dissipation power                    | 43 W  | 51 W  | 64 W  | 63 W  | 81 W  |
| Maximum current                           | 125A  | 125A  | 125A  | 125A  | 125A  |
| Extractable frame                         | yes   | yes   | yes   | yes   | yes   |
| Additional module                         | yes   | yes   | yes   | yes   | yes   |
| Installation of MCCBs                     | yes   | yes   | yes   | yes   | yes   |
| DIN rail centre distance                  | 150 - 125 (mm)                              | 150 - 125 (mm)                              | 150 - 125 (mm)                              | 150 - 125 (mm)                              | 150 - 125 (mm)                              |
| Halogen free                              | yes   | yes   | yes   | yes   | yes   |
| Cable entry finish                        | Smooth                                      | Smooth                                      | Smooth                                      | Smooth                                      | Smooth                                      |

Reference standards IEC60670 - EN60439-3



| Codes                                     | 1SL1210A00   | 1SL1211A00   | 1SL1212A00   | 1SL1213A00   | 1SL1214A00   |
|---|--|--|--|--|--|
| Number of modules                         | 4  | 8  | 12   | 18   | 24   |
| Dimensions (WxHxD) in mm                  | 152 x 202 x 117  | 232 x 250 x 154  | 320 x 250 x 155  | 430 x 250 x 155  | 320 x 435 x 155  |
| Colour                                    | RAL 7035 grey  | RAL 7035 grey  | RAL 7035 grey  | RAL 7035 grey  | RAL 7035 grey  |
| Door type                                 | Transparent  | Transparent  | Transparent  | Transparent  | Transparent  |
| Protection class                          | II  | II  | II  | II  | II  |
| Fire resistance                           | GWT 750°C  | GWT 750°C  | GWT 750°C  | GWT 750°C  | GWT 750°C  |
| Material                                  | Thermoplastic  | Thermoplastic  | Thermoplastic  | Thermoplastic  | Thermoplastic  |
| Resistance to mechanical impacts          | IK09   | IK09   | IK09   | IK09   | IK09   |
| Knockout resistance to mechanical impacts | IK08   | IK08   | IK08   | IK08   | IK08   |
| Installation temperature                  | -25°C / +60°C  | -25°C / +60°C  | -25°C / +60°C  | -25°C / +60°C  | -25°C / +60°C  |
| Resistance to heat                        | BPT 70°C   | BPT 70°C   | BPT 70°C   | BPT 70°C   | BPT 70°C   |
| IP rating                                 | IP65   | IP65   | IP65   | IP65   | IP65   |
| Max. dissipation power                    | 12 W   | 20 W   | 27 W   | 32 W   | 34 W   |
| Maximum current                           | 63A  | 63A  | 63A  | 125A   | 125A   |
| Extractable frame                         | no   | no   | no   | no   | yes  |
| Additional module                         | no   | no   | yes  | yes  | yes  |
| Installation of MCCBs                     | no   | yes  | yes  | yes  | yes  |
| DIN rail centre distance                  | -  | -  | -  | -  | 150 - 125 (mm)   |
| Halogen free                              | no   | no   | no   | no   | no   |
| Cable entry finish                        | Precut   | Precut   | Precut   | Precut   | Precut   |

| Codes                                     | 1SL1215A00   | 1SL1216A00   | 1SL1217A00   | 1SL1218A00   | 1SL1219A00   |
|---|--|--|--|--|--|
| Number of modules                         | 36   | 36   | 48   | 54   | 72   |
| Dimensions (WxHxD) in mm                  | 430 x 435 x 155  | 320 x 435 x 155  | 320 x 735 x 155  | 430 x 600 x 155  | 430 x 735 x 155  |
| Colour                                    | RAL 7035 grey  | RAL 7035 grey  | RAL 7035 grey  | RAL 7035 grey  | RAL 7035 grey  |
| Door type                                 | Transparent  | Transparent  | Transparent  | Transparent  | Transparent  |
| Protection class                          | II  | II  | II  | II  | II  |
| Fire resistance                           | GWT 750°C  | GWT 750°C  | GWT 750°C  | GWT 750°C  | GWT 750°C  |
| Material                                  | Thermoplastic  | Thermoplastic  | Thermoplastic  | Thermoplastic  | Thermoplastic  |
| Resistance to mechanical impacts          | IK09   | IK09   | IK09   | IK09   | IK09   |
| Knockout resistance to mechanical impacts | IK08   | IK08   | IK08   | IK08   | IK08   |
| Installation temperature                  | -25°C / +60°C  | -25°C / +60°C  | -25°C / +60°C  | -25°C / +60°C  | -25°C / +60°C  |
| Resistance to heat                        | BPT 70°C   | BPT 70°C   | BPT 70°C   | BPT 70°C   | BPT 70°C   |
| IP rating                                 | IP65   | IP65   | IP65   | IP65   | IP65   |
| Max. dissipation power                    | 43 W   | 51 W   | 64 W   | 63 W   | 81 W   |
| Maximum current                           | 125A   | 125A   | 125A   | 125A   | 125A   |
| Extractable frame                         | yes  | yes  | yes  | yes  | yes  |
| Additional module                         | yes  | yes  | yes  | yes  | yes  |
| Installation of MCCBs                     | yes  | yes  | yes  | yes  | yes  |
| DIN rail centre distance                  | 150 - 125 (mm)   | 150 - 125 (mm)   | 150 - 125 (mm)   | 150 - 125 (mm)   | 150 - 125 (mm)   |
| Halogen free                              | no   | no   | no   | no   | no   |
| Cable entry finish                        | Precut   | Precut   | Precut   | Precut   | Precut   |

Reference standards IEC60670 - EN60439-3

# Technical details

Table of resistance to chemical agents

|                                       | Cold water | Hot water | Sulphuric acid | Hydrochloric acid | Acetic acid | Petroleum | Benzine | Acetone | Ethyl alcohol | Ammonia | Dichloromethane | Diesel oil - Naptha | Mineral oil | Food oils | Tetrachloroethylene | Trichloroethylene | Ether | Ozone | Toluene | Methyl alcohol | Alcohol | Milk | Fruit juices | Fluorocarbons | Detergives | Detergents | Potassium nitrate | Hydrogen peroxide |
|---------------------------------------|------------|-----------|----------------|-------------------|-------------|-----------|---------|---------|---------------|---------|-----------------|---------------------|-------------|-----------|---------------------|-------------------|-------|-------|---------|----------------|---------|------|--------------|---------------|------------|------------|-------------------|-------------------|
| <b>MISTRAL65 - IP65 consumer unit</b> | ■          | ■         | ▲              | ●                 | ■           | ●         | ●       | ●       | ▲             | ■       | ●               | ▲                   | ■           | ■         | ●                   | ●                 | ●     | ■     | ●       | ▲              | ■       | ■    | ■            | ●             | ■          | ■          | ▲                 | ■                 |

■ resistant    
 ▲ partially resistant    
 ● non resistant

## Ingress protection rating IP65

**6** First number:  
Protection against the penetration of solid bodies  
No dust can penetrate

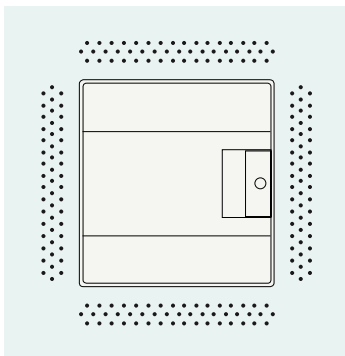

**5** Second number:  
Protection against the penetration of water  
Water projected with a nozzle from all directions must not cause damage

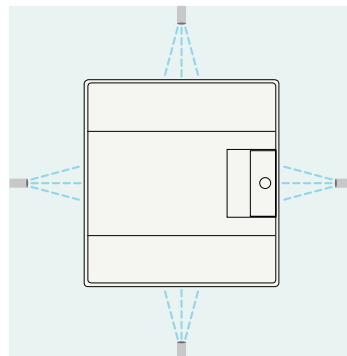

# Upper and lower knockouts

| Modules |      | Cable Glands |          |          |
|---------|------|--------------|----------|----------|
|         |      | diam. 16     | diam. 20 | diam. 25 |
| 4       | 04x1 | 2            | -        | -        |
| 8       | 08x1 | 3            | 3        | -        |
| 12      | 12x1 | 2            | 2        | 2        |
| 24      | 12x2 | 5            | 5        | 2        |
| 36      | 12x3 | 5            | 5        | 2        |
| 48      | 12x4 | 5            | 5        | 2        |
| 18      | 18x1 | 2            | 2        | 2        |
| 36      | 18x2 | 5            | 5        | 2        |
| 54      | 18x3 | 5            | 5        | 2        |
| 72      | 18x4 | 5            | 5        | 2        |

| Modules |      | Holes    |          |          |          |          |
|---------|------|----------|----------|----------|----------|----------|
|         |      | diam. 12 | diam. 16 | diam. 20 | diam. 25 | diam. 32 |
| 4       | 04x1 | 4        | 4        | -        | -        | -        |
| 8       | 08x1 | -        | 6        | 7        | 2        | -        |
| 12      | 12x1 | -        | 10       | 7        | 4        | 2        |
| 24      | 12x2 | -        | 10       | 7        | 4        | 2        |
| 36      | 12x3 | -        | 10       | 7        | 4        | 2        |
| 48      | 12x4 | -        | 10       | 7        | 4        | 2        |
| 18      | 18x1 | -        | 14       | 9        | 4        | 2        |
| 36      | 18x2 | -        | 14       | 9        | 4        | 2        |
| 54      | 18x3 | -        | 14       | 9        | 4        | 2        |
| 72      | 18x4 | -        | 14       | 9        | 4        | 2        |

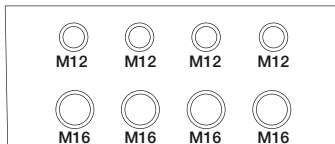

4 modules - top and bottom

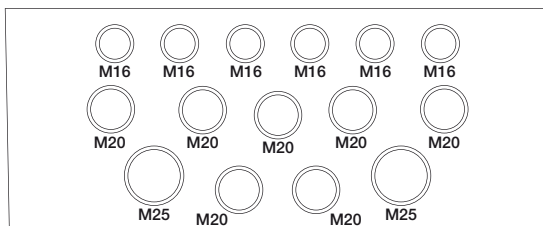

8 modules - top and bottom

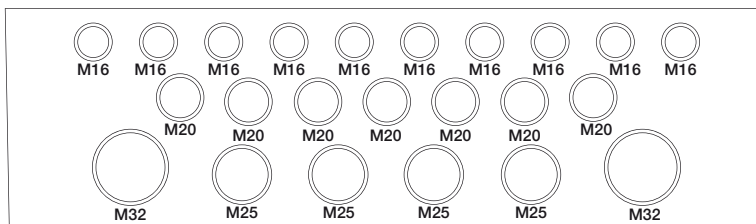

12 modules - top and bottom

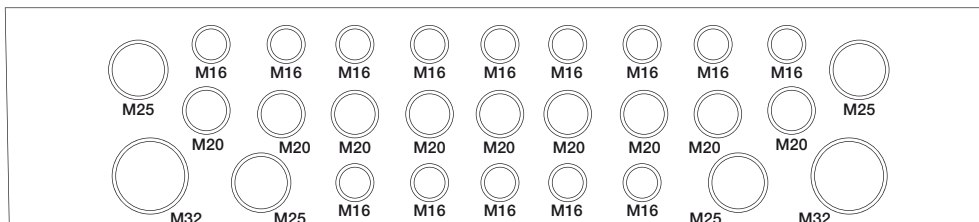

18 modules - top and bottom

# Overall dimensions

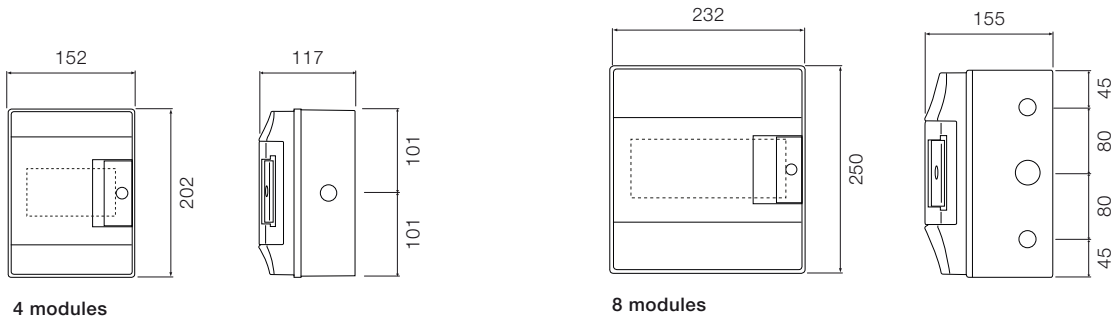

4 modules

8 modules

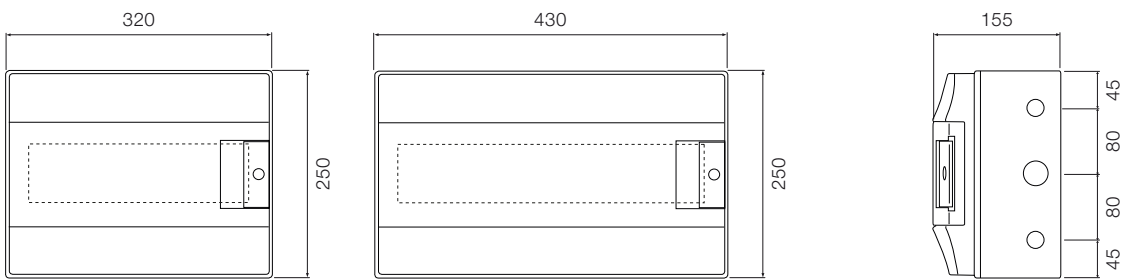

12 modules

18 modules

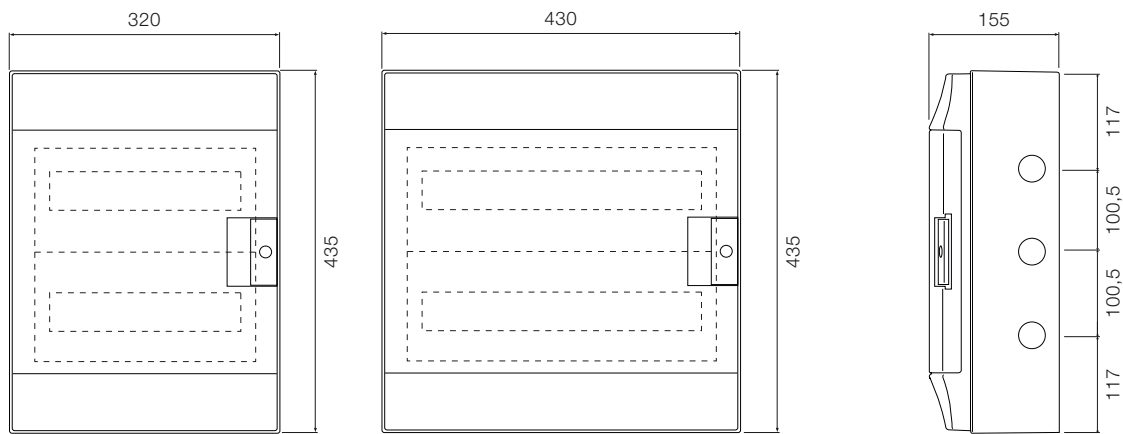

24 modules

36 modules

Dimensions in mm

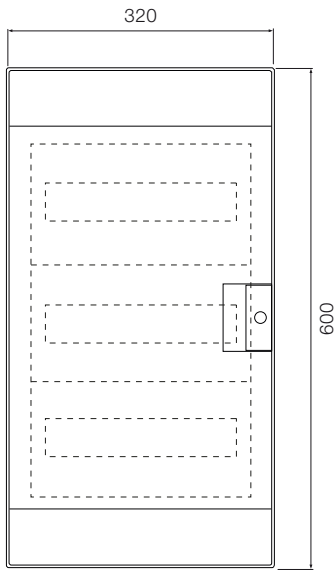

36 modules

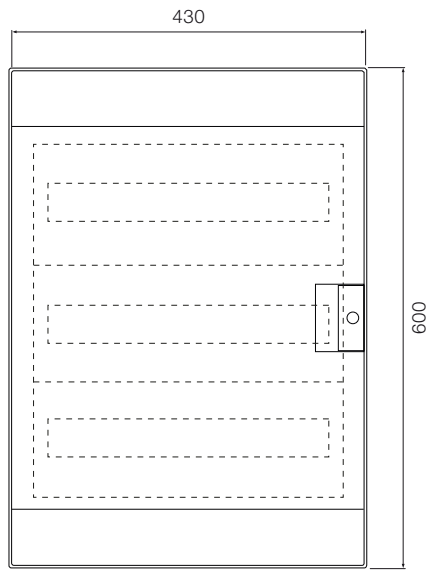

54 modules

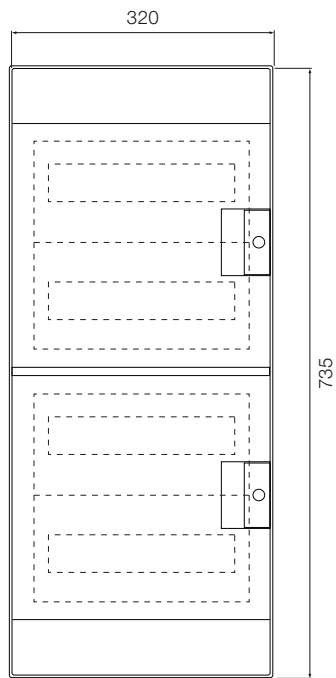
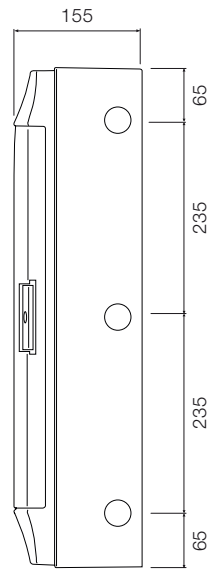

48 modules

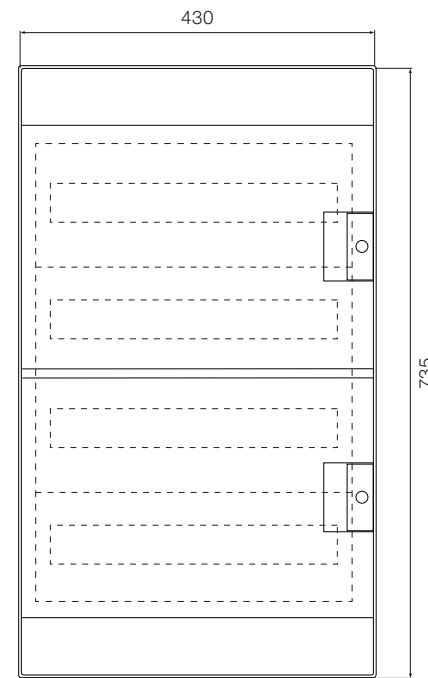

72 modules

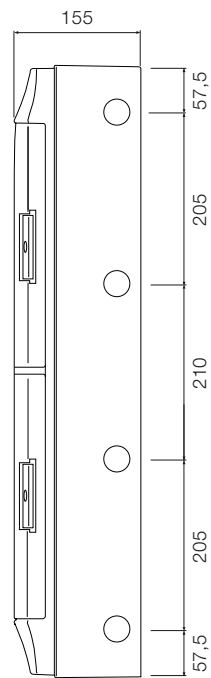

Dimensions in mm

# Overall dimensions

## Consumer unit fixing template

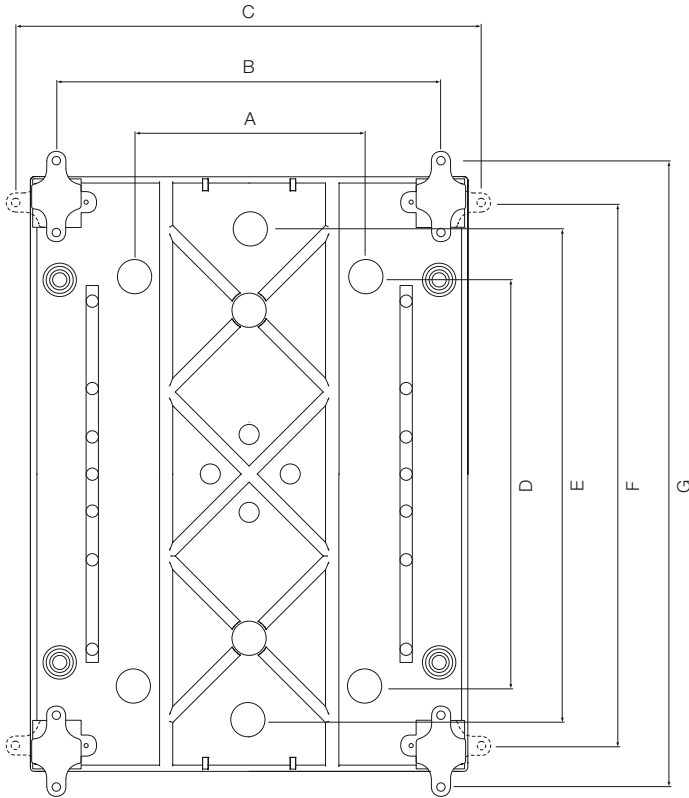

|                         | A   | B     | C     | D   | E   | F   | G     |
|-------------------------|-----|-------|-------|-----|-----|-----|-------|
| <b>4 Modules</b>        |     | 113   | 173   |     | 140 | 163 | 223,5 |
| <b>8 Modules</b>        | 90  | 194   | 254,5 | 180 |     | 212 | 272,5 |
| <b>12 Modules</b>       | 170 | 282,5 | 343   | 180 |     | 212 | 272,5 |
| <b>18 Modules</b>       | 280 | 392   | 452,5 | 125 | 175 | 212 | 272,5 |
| <b>24 Modules</b>       | 170 | 282,5 | 343   | 310 | 360 | 397 | 457,5 |
| <b>36 Modules - 2 F</b> | 280 | 392   | 452,5 | 310 | 360 | 397 | 457,5 |
| <b>36 Modules - 3 F</b> | 170 | 282,5 | 343   | 475 | 525 | 562 | 622,5 |
| <b>48 Modules</b>       | 170 | 282,5 | 343   | 610 | 660 | 697 | 757,5 |
| <b>54 Modules</b>       | 280 | 392   | 452,5 | 475 | 525 | 562 | 622,5 |
| <b>72 Modules</b>       | 280 | 392   | 452,5 | 610 | 660 | 697 | 757,5 |

Dimensions in mm

# List of quick reference codes

| ABB code        | Type                                   | Pag. | ABB code        | Type   | Pag. |
|-----------------|--|------|-----------------|--|------|
| 1SL1100A00      | MISTRAL65 opaque door 4M               | 12   | 1SLM006500A1929 | Module cover 12M MISTRAL65   | 19   |
| 1SL1101A00      | MISTRAL65 opaque door 8M               | 12   | 1SLM006500A1931 | Lock with key MISTRAL65  | 19   |
| 1SL1102A00      | MISTRAL65 opaque door 12M              | 12   | 1SLM006500A1935 | Cable gland Ø 16   | 19   |
| 1SL1103A00      | MISTRAL65 opaque door 18M              | 12   | 1SLM006500A1936 | Cable gland Ø 20   | 19   |
| 1SL1104A00      | MISTRAL65 opaque door 24M              | 12   | 1SLM006500A1937 | Cable gland Ø 25   | 19   |
| 1SL1105A00      | MISTRAL65 opaque door 36M 2F           | 12   | 1SLM006500A1938 | Cable gland Ø 32   | 19   |
| 1SL1106A00      | MISTRAL65 opaque door 36M 3F           | 13   | 1SLM006500A1942 | Adapter for trunking MISTRAL65   | 19   |
| 1SL1107A00      | MISTRAL65 opaque door 48M              | 13   | 1SLM006500A1945 | Central blind panel 12M MISTRAL65  | 18   |
| 1SL1108A00      | MISTRAL65 opaque door 54M              | 13   | 1SLM006500A1946 | Blind panel 12M MISTRAL65  | 18   |
| 1SL1109A00      | MISTRAL65 opaque door 72M              | 13   | 1SLM006500A1947 | Central blind panel 18M MISTRAL65  | 18   |
| 1SL1200A00      | MISTRAL65 transparent door 4M          | 12   | 1SLM006500A1948 | Blind panel 18M MISTRAL65  | 18   |
| 1SL1201A00      | MISTRAL65 transparent door 8M          | 12   | 1SLM006500A1949 | Junction unit Ø 28,5 MISTRAL65   | 19   |
| 1SL1202A00      | MISTRAL65 transparent door 12M         | 12   | 1SLM006500A1950 | Sealing kit MISTRAL65  | 19   |
| 1SL1203A00      | MISTRAL65 transparent door 18M         | 12   | 1SLM006501A1201 | MISTRAL65 transparent door 8M 12SM                                       | 16   |
| 1SL1204A00      | MISTRAL65 transparent door 24M         | 12   | 1SLM006501A1202 | MISTRAL65 transparent door 12M 22SM                                      | 16   |
| 1SL1205A00      | MISTRAL65 transparent door 36M 2F      | 12   | 1SLM006501A1203 | MISTRAL65 transparent door 18M 12SM                                      | 16   |
| 1SL1206A00      | MISTRAL65 transparent door 36M 3F      | 13   | 1SLM006501A1204 | MISTRAL65 transparent door 24M 22SM                                      | 16   |
| 1SL1207A00      | MISTRAL65 transparent door 48M         | 13   | 1SLM006501A1205 | MISTRAL65 transparent door 36M 2F 52SM                                   | 17   |
| 1SL1208A00      | MISTRAL65 transparent door 54M         | 13   | 1SLM006501A1206 | MISTRAL65 transparent door 36M 3F 42SM                                   | 17   |
| 1SL1209A00      | MISTRAL65 transparent door 72M         | 13   | 1SLM006501A1207 | MISTRAL65 transparent door 48M 52SM                                      | 17   |
| 1SLM006500A1210 | MISTRAL65 750 transparent door 4M      | 14   | 1SLM006501A1208 | MISTRAL65 transparent door 54M 52SM                                      | 17   |
| 1SLM006500A1211 | MISTRAL65 750 transparent door 8M      | 14   | 1SLM006501A1209 | MISTRAL65 transparent door 72M 52SM                                      | 17   |
| 1SLM006500A1212 | MISTRAL65 750 transparent door 12M     | 14   | 1SLM006502A1203 | MISTRAL65 transparent door 18M 32SM                                      | 16   |
| 1SLM006500A1213 | MISTRAL65 750 transparent door 18M     | 14   | 1SLM006502A1204 | MISTRAL65 transparent door 24M 42SM                                      | 16   |
| 1SLM006500A1214 | MISTRAL65 750 transparent door 24M     | 14   | 1SPE007715F0731 | Terminal block N 3x16mm <sup>2</sup> +3x6mm <sup>2</sup>                 | 20   |
| 1SLM006500A1215 | MISTRAL65 750 transparent door 36M 2F  | 14   | 1SPE007715F0732 | Terminal block N 5x16mm <sup>2</sup> +6x6mm <sup>2</sup>                 | 20   |
| 1SLM006500A1216 | MISTRAL65 750 transparent door 36M 3F  | 15   | 1SPE007715F0733 | Terminal block N 7x16mm <sup>2</sup> +9x6mm <sup>2</sup>                 | 20   |
| 1SLM006500A1217 | MISTRAL65 750 transparent door 48M     | 15   | 1SPE007715F0734 | Terminal block N 9x16mm <sup>2</sup> +12x6mm <sup>2</sup>                | 20   |
| 1SLM006500A1218 | MISTRAL65 750 transparent door 54M     | 15   | 1SPE007715F0735 | Terminal block N 11x16mm <sup>2</sup> +15x6mm <sup>2</sup>               | 20   |
| 1SLM006500A1219 | MISTRAL65 750 transparent door 72M     | 15   | 1SPE007715F0741 | Terminal block PE 3x16mm <sup>2</sup> +3x6mm <sup>2</sup>                | 20   |
| 1SLM006500A1900 | Opaque door 4M MISTRAL65               | 18   | 1SPE007715F0742 | Terminal block PE 5x16mm <sup>2</sup> +6x6mm <sup>2</sup>                | 20   |
| 1SLM006500A1901 | Transparent door 4M MISTRAL65          | 18   | 1SPE007715F0743 | Terminal block PE 7x16mm <sup>2</sup> +9x6mm <sup>2</sup>                | 20   |
| 1SLM006500A1902 | Opaque door 8M MISTRAL65               | 18   | 1SPE007715F0744 | Terminal block PE 9x16mm <sup>2</sup> +12x6mm <sup>2</sup>               | 20   |
| 1SLM006500A1903 | Transparent door 8M MISTRAL65          | 18   | 1SPE007715F0745 | Terminal block PE 11x16mm <sup>2</sup> +15x6mm <sup>2</sup>              | 20   |
| 1SLM006500A1904 | Opaque door 12M MISTRAL65              | 18   | 1SPE007715F0751 | Terminal carrier 8M MISTRAL65  | 19   |
| 1SLM006500A1905 | Transparent door 12M MISTRAL65         | 18   | 1SPE007715F0752 | Terminal carrier 12M MISTRAL65   | 19   |
| 1SLM006500A1906 | Opaque door 18M MISTRAL65              | 18   | 1SPE007715F0753 | Terminal carrier 18M MISTRAL65   | 19   |
| 1SLM006500A1907 | Transparent door 18M MISTRAL65         | 18   | 1SPE007715F9701 | Terminal block screwless N 5x1,5-4mm <sup>2</sup>                        | 20   |
| 1SLM006500A1908 | Opaque door 24M / 48M MISTRAL65        | 18   | 1SPE007715F9702 | Terminal block screwless N 5x1,5-4mm <sup>2</sup> +1x25mm <sup>2</sup>   | 20   |
| 1SLM006500A1909 | Transparent door 24M / 48M MISTRAL65   | 18   | 1SPE007715F9703 | Terminal block screwless N 8x1,5-4mm <sup>2</sup> +2x25mm <sup>2</sup>   | 20   |
| 1SLM006500A1910 | Opaque door 36M MISTRAL65              | 18   | 1SPE007715F9704 | Terminal block screwless N 11x1,5-4mm <sup>2</sup> +3x25mm <sup>2</sup>  | 20   |
| 1SLM006500A1911 | Transparent door 36M MISTRAL65         | 18   | 1SPE007715F9705 | Terminal block screwless N 14x1,5-4mm <sup>2</sup> +4x25mm <sup>2</sup>  | 20   |
| 1SLM006500A1912 | Opaque door 36M / 72M MISTRAL65        | 18   | 1SPE007715F9706 | Terminal block screwless N 17x1,5-4mm <sup>2</sup> +5x25mm <sup>2</sup>  | 20   |
| 1SLM006500A1913 | Transparent door 36M / 72M MISTRAL65   | 18   | 1SPE007715F9707 | Terminal block screwless N 20x1,5-4mm <sup>2</sup> +6x25mm <sup>2</sup>  | 20   |
| 1SLM006500A1914 | Opaque door 54M MISTRAL65              | 18   | 1SPE007715F9712 | Terminal block screwless PE 5x1,5-4mm <sup>2</sup> +1x25mm <sup>2</sup>  | 20   |
| 1SLM006500A1915 | Transparent door 54M MISTRAL65         | 18   | 1SPE007715F9713 | Terminal block screwless PE 8x1,5-4mm <sup>2</sup> +2x25mm <sup>2</sup>  | 20   |
| 1SLM006500A1920 | Metal base plate 12M MISTRAL65         | 18   | 1SPE007715F9714 | Terminal block screwless PE 11x1,5-4mm <sup>2</sup> +3x25mm <sup>2</sup> | 20   |
| 1SLM006500A1921 | Metal base plate 2x12M MISTRAL65       | 18   | 1SPE007715F9715 | Terminal block screwless PE 14x1,5-4mm <sup>2</sup> +4x25mm <sup>2</sup> | 20   |
| 1SLM006500A1922 | Metal base plate 18M MISTRAL65         | 18   | 1SPE007715F9716 | Terminal block screwless PE 17x1,5-4mm <sup>2</sup> +5x25mm <sup>2</sup> | 20   |
| 1SLM006500A1923 | Metal base plate 2x18M MISTRAL65       | 18   | 1SPE007715F9717 | Terminal block screwless PE 20x1,5-4mm <sup>2</sup> +6x25mm <sup>2</sup> | 20   |
| 1SLM006500A1927 | Wall fixing brackets (4 pcs) MISTRAL65 | 19   |                 |  |      |

# List of quick reference codes

| Order code | Type                                   | Pag. |
|------------|--|------|
| 1SL1100A00 | MISTRAL65 opaque door 4M               | 12   |
| 1SL1101A00 | MISTRAL65 opaque door 8M               | 12   |
| 1SL1102A00 | MISTRAL65 opaque door 12M              | 12   |
| 1SL1103A00 | MISTRAL65 opaque door 18M              | 12   |
| 1SL1104A00 | MISTRAL65 opaque door 24M              | 12   |
| 1SL1105A00 | MISTRAL65 opaque door 36M 2F           | 12   |
| 1SL1106A00 | MISTRAL65 opaque door 36M 3F           | 13   |
| 1SL1107A00 | MISTRAL65 opaque door 48M              | 13   |
| 1SL1108A00 | MISTRAL65 opaque door 54M              | 13   |
| 1SL1109A00 | MISTRAL65 opaque door 72M              | 13   |
| 1SL1200A00 | MISTRAL65 transparent door 4M          | 12   |
| 1SL1201A00 | MISTRAL65 transparent door 8M          | 12   |
| 1SL1202A00 | MISTRAL65 transparent door 12M         | 12   |
| 1SL1203A00 | MISTRAL65 transparent door 18M         | 12   |
| 1SL1204A00 | MISTRAL65 transparent door 24M         | 12   |
| 1SL1205A00 | MISTRAL65 transparent door 36M 2F      | 12   |
| 1SL1206A00 | MISTRAL65 transparent door 36M 3F      | 13   |
| 1SL1207A00 | MISTRAL65 transparent door 48M         | 13   |
| 1SL1208A00 | MISTRAL65 transparent door 54M         | 13   |
| 1SL1209A00 | MISTRAL65 transparent door 72M         | 13   |
| 1SL1210A00 | MISTRAL65 750 transparent door 4M      | 14   |
| 1SL1211A00 | MISTRAL65 750 transparent door 8M      | 14   |
| 1SL1212A00 | MISTRAL65 750 transparent door 12M     | 14   |
| 1SL1213A00 | MISTRAL65 750 transparent door 18M     | 14   |
| 1SL1214A00 | MISTRAL65 750 transparent door 24M     | 14   |
| 1SL1215A00 | MISTRAL65 750 transparent door 36M 2F  | 14   |
| 1SL1216A00 | MISTRAL65 750 transparent door 36M 3F  | 15   |
| 1SL1217A00 | MISTRAL65 750 transparent door 48M     | 15   |
| 1SL1218A00 | MISTRAL65 750 transparent door 54M     | 15   |
| 1SL1219A00 | MISTRAL65 750 transparent door 72M     | 15   |
| 1SL1900A00 | Opaque door 4M MISTRAL65               | 18   |
| 1SL1901A00 | Transparent door 4M MISTRAL65          | 18   |
| 1SL1902A00 | Opaque door 8M MISTRAL65               | 18   |
| 1SL1903A00 | Transparent door 8M MISTRAL65          | 18   |
| 1SL1904A00 | Opaque door 12M MISTRAL65              | 18   |
| 1SL1905A00 | Transparent door 12M MISTRAL65         | 18   |
| 1SL1906A00 | Opaque door 18M MISTRAL65              | 18   |
| 1SL1907A00 | Transparent door 18M MISTRAL65         | 18   |
| 1SL1908A00 | Opaque door 24M / 48M MISTRAL65        | 18   |
| 1SL1909A00 | Transparent door 24M / 48M MISTRAL65   | 18   |
| 1SL1910A00 | Opaque door 36M MISTRAL65              | 18   |
| 1SL1911A00 | Transparent door 36M MISTRAL65         | 18   |
| 1SL1912A00 | Opaque door 36M / 72M MISTRAL65        | 18   |
| 1SL1913A00 | Transparent door 36M / 72M MISTRAL65   | 18   |
| 1SL1914A00 | Opaque door 54M MISTRAL65              | 18   |
| 1SL1915A00 | Transparent door 54M MISTRAL65         | 18   |
| 1SL1920A00 | Metal base plate 12M MISTRAL65         | 18   |
| 1SL1921A00 | Metal base plate 2x12M MISTRAL65       | 18   |
| 1SL1922A00 | Metal base plate 18M MISTRAL65         | 18   |
| 1SL1923A00 | Metal base plate 2x18M MISTRAL65       | 18   |
| 1SL1927A00 | Wall fixing brackets (4 pcs) MISTRAL65 | 19   |

| Order code      | Type   | Pag. |
|-----------------|--|------|
| 1SL1929A00      | Module cover 12M MISTRAL65   | 19   |
| 1SL1931A00      | Lock with key MISTRAL65  | 19   |
| 1SL1935A00      | Cable gland Ø 16   | 19   |
| 1SL1936A00      | Cable gland Ø 20   | 19   |
| 1SL1937A00      | Cable gland Ø 25   | 19   |
| 1SL1938A00      | Cable gland Ø 32   | 19   |
| 1SL1942A00      | Adapter for trunking MISTRAL65   | 19   |
| 1SL1945A00      | Central blind panel 12M MISTRAL65  | 18   |
| 1SL1946A00      | Blind panel 12M MISTRAL65  | 18   |
| 1SL1947A00      | Central blind panel 18M MISTRAL65  | 18   |
| 1SL1948A00      | Blind panel 18M MISTRAL65  | 18   |
| 1SL1949A00      | Junction unit Ø 28,5 MISTRAL65   | 19   |
| 1SL1950A00      | Sealing kit MISTRAL65  | 19   |
| 1SLM006501A1201 | MISTRAL65 transparent door 8M 12SM                                       | 16   |
| 1SLM006501A1202 | MISTRAL65 transparent door 12M 22SM                                      | 16   |
| 1SLM006501A1203 | MISTRAL65 transparent door 18M 12SM                                      | 16   |
| 1SLM006501A1204 | MISTRAL65 transparent door 24M 22SM                                      | 16   |
| 1SLM006501A1205 | MISTRAL65 transparent door 36M 2F 52SM                                   | 17   |
| 1SLM006501A1206 | MISTRAL65 transparent door 36M 3F 42SM                                   | 17   |
| 1SLM006501A1207 | MISTRAL65 transparent door 48M 52SM                                      | 17   |
| 1SLM006501A1208 | MISTRAL65 transparent door 54M 52SM                                      | 17   |
| 1SLM006501A1209 | MISTRAL65 transparent door 72M 52SM                                      | 17   |
| 1SLM006502A1203 | MISTRAL65 transparent door 18M 32SM                                      | 16   |
| 1SLM006502A1204 | MISTRAL65 transparent door 24M 42SM                                      | 16   |
| 1SPE007715F0731 | Terminal block N 3x16mm <sup>2</sup> +3x6mm <sup>2</sup>                 | 20   |
| 1SPE007715F0732 | Terminal block N 5x16mm <sup>2</sup> +6x6mm <sup>2</sup>                 | 20   |
| 1SPE007715F0733 | Terminal block N 7x16mm <sup>2</sup> +9x6mm <sup>2</sup>                 | 20   |
| 1SPE007715F0734 | Terminal block N 9x16mm <sup>2</sup> +12x6mm <sup>2</sup>                | 20   |
| 1SPE007715F0735 | Terminal block N 11x16mm <sup>2</sup> +15x6mm <sup>2</sup>               | 20   |
| 1SPE007715F0741 | Terminal block PE 3x16mm <sup>2</sup> +3x6mm <sup>2</sup>                | 20   |
| 1SPE007715F0742 | Terminal block PE 5x16mm <sup>2</sup> +6x6mm <sup>2</sup>                | 20   |
| 1SPE007715F0743 | Terminal block PE 7x16mm <sup>2</sup> +9x6mm <sup>2</sup>                | 20   |
| 1SPE007715F0744 | Terminal block PE 9x16mm <sup>2</sup> +12x6mm <sup>2</sup>               | 20   |
| 1SPE007715F0745 | Terminal block PE 11x16mm <sup>2</sup> +15x6mm <sup>2</sup>              | 20   |
| 1SPE007715F0751 | Terminal carrier 8M MISTRAL65  | 19   |
| 1SPE007715F0752 | Terminal carrier 12M MISTRAL65   | 19   |
| 1SPE007715F0753 | Terminal carrier 18M MISTRAL65   | 19   |
| 1SPE007715F9701 | Terminal block screwless N 5x1,5-4mm <sup>2</sup>                        | 20   |
| 1SPE007715F9702 | Terminal block screwless N 5x1,5-4mm <sup>2</sup> +1x25mm <sup>2</sup>   | 20   |
| 1SPE007715F9703 | Terminal block screwless N 8x1,5-4mm <sup>2</sup> +2x25mm <sup>2</sup>   | 20   |
| 1SPE007715F9704 | Terminal block screwless N 11x1,5-4mm <sup>2</sup> +3x25mm <sup>2</sup>  | 20   |
| 1SPE007715F9705 | Terminal block screwless N 14x1,5-4mm <sup>2</sup> +4x25mm <sup>2</sup>  | 20   |
| 1SPE007715F9706 | Terminal block screwless N 17x1,5-4mm <sup>2</sup> +5x25mm <sup>2</sup>  | 20   |
| 1SPE007715F9707 | Terminal block screwless N 20x1,5-4mm <sup>2</sup> +6x25mm <sup>2</sup>  | 20   |
| 1SPE007715F9712 | Terminal block screwless PE 5x1,5-4mm <sup>2</sup> +1x25mm <sup>2</sup>  | 20   |
| 1SPE007715F9713 | Terminal block screwless PE 8x1,5-4mm <sup>2</sup> +2x25mm <sup>2</sup>  | 20   |
| 1SPE007715F9714 | Terminal block screwless PE 11x1,5-4mm <sup>2</sup> +3x25mm <sup>2</sup> | 20   |
| 1SPE007715F9715 | Terminal block screwless PE 14x1,5-4mm <sup>2</sup> +4x25mm <sup>2</sup> | 20   |
| 1SPE007715F9716 | Terminal block screwless PE 17x1,5-4mm <sup>2</sup> +5x25mm <sup>2</sup> | 20   |
| 1SPE007715F9717 | Terminal block screwless PE 20x1,5-4mm <sup>2</sup> +6x25mm <sup>2</sup> | 20   |





# Contact us

## **ABB SACE**

**A division of ABB S.p.A.**

**Enclosures and Cable Systems**

Viale Vicenza, 61

36063 Marostica (VI) - Italy

Tel.: +39 0424 478200

Fax: +39 0424 478305

**[www.abb.com](http://www.abb.com)**

The data and illustrations are not binding. We reserve the right to modify the contents of this document on the basis of technical development of the products, without prior notice.

Copyright 2013 ABB. All right reserved.

1SLC801010D0202 - 12/2013